

DENON

AV SURROUND RECEIVER

AVR-3311

Owner's Manual

Manuel de l'Utilisateur

Manual del usuario



Simple version Version simplifiée
Versión sencilla



Basic version Version basique
Versión básica



Advanced version Version avancée
Versión avanzada



Information "Part names and functions"
(☞ page 95)



Informations
"Nomenclature et fonctions"
(☞ page 95)
Información
"Nombres y funciones de las piezas" (☞ página 95)

□ SAFETY PRECAUTIONS



CAUTION
RISK OF ELECTRIC SHOCK
DO NOT OPEN



CAUTION:
TO REDUCE THE RISK OF ELECTRIC SHOCK, DO NOT REMOVE COVER (OR BACK). NO USER-SERVICEABLE PARTS INSIDE. REFER SERVICING TO QUALIFIED SERVICE PERSONNEL.

The lightning flash with arrowhead symbol, within an equilateral triangle, is intended to alert the user to the presence of uninsulated "dangerous voltage" within the product's enclosure that may be of sufficient magnitude to constitute a risk of electric shock to persons.

The exclamation point within an equilateral triangle is intended to alert the user to the presence of important operating and maintenance (servicing) instructions in the literature accompanying the appliance.

WARNING:
TO REDUCE THE RISK OF FIRE OR ELECTRIC SHOCK, DO NOT EXPOSE THIS APPLIANCE TO RAIN OR MOISTURE.

IMPOTANT SAFETY INSTRUCTIONS

1. Read these instructions.
2. Keep these instructions.
3. Heed all warnings.
4. Follow all instructions.
5. Do not use this apparatus near water.
6. Clean only with dry cloth.
7. Do not block any ventilation openings. Install in accordance with the manufacturer's instructions.
8. Do not install near any heat sources such as radiators, heat registers, stoves, or other apparatus (including amplifiers) that produce heat.
9. Protect the power cord from being walked on or pinched particularly at plugs, convenience receptacles, and the point where they exit from the apparatus.
10. Only use attachments/accessories specified by the manufacturer.
11. Use only with the cart, stand, tripod, bracket, or table specified by the manufacturer, or sold with the apparatus. When a cart is used, use caution when moving the cart/apparatus combination to avoid injury from tip-over.
12. Unplug this apparatus during lightning storms or when unused for long periods of time.
13. Refer all servicing to qualified service personnel. Servicing is required when the apparatus has been damaged in any way, such as power-supply cord or plug is damaged, liquid has been spilled or objects have fallen into the apparatus, the apparatus has been exposed to rain or moisture, does not operate normally, or has been dropped.
14. Batteries shall not be exposed to excessive heat such as sunshine, fire or the like.



CAUTION:

To completely disconnect this product from the mains, disconnect the plug from the wall socket outlet. The mains plug is used to completely interrupt the power supply to the unit and must be within easy access by the user.

VORSICHT:

Um dieses Gerät vollständig von der Stromversorgung abzutrennen, ziehen Sie bitte den Stecker aus der Wandsteckdose. Der Netzstecker wird verwendet, um die Stromversorgung zum Gerät völlig zu unterbrechen; er muss für den Benutzer gut und einfach zu erreichen sein.

PRECAUTION:

Pour déconnecter complètement ce produit du courant secteur, débranchez la prise de la prise murale. La prise secteur est utilisée pour couper complètement l'alimentation de l'appareil et l'utilisateur doit pouvoir y accéder facilement.

ATTENZIONE:

Per scollegare completamente questo prodotto dalla rete di alimentazione elettrica, scollegare la spina dalla relativa presa a muro. La spina di rete viene utilizzata per interrompere completamente l'alimentazione all'unità e deve essere facilmente accessibile all'utente.

PRECAUCIÓN:

Para desconectar completamente este producto de la alimentación eléctrica, desconecte el enchufe del enchufe de la pared. El enchufe de la alimentación eléctrica se utiliza para interrumpir por completo el suministro de alimentación eléctrica a la unidad y debe de encontrarse en un lugar al que el usuario tenga fácil acceso.

WAARSCHUWING:

Om de voeding van dit product volledig te onderbreken moet de stekker uit het stopcontact worden getrokken. De netstekker wordt gebruikt om de stroomtoevoer naar het toestel volledig te onderbreken en moet voor de gebruiker gemakkelijk bereikbaar zijn.

FÖRSIKTIHETSMÅTT:

Koppla loss stickproppen från eluttaget för att helt skilja produkten från nätet. Stickproppen används för att helt bryta strömförsörjningen till apparaten, och den måste vara lättillgänglig för användaren.

NOTE ON USE / HINWEIS ZUM GEBRAUCH / OBSERVATIONS RELATIVES A L'UTILISATION / NOTE SULL'USO / NOTAS SOBRE EL USO / ALVORENSTE GEBRUIKEN / OBSERVERA ANGÅENDE ANVÄNDNINGEN

WARNINGS	WARNHINWEISE	AVERTISSEMENTS	AVVERTENZE	ADVERTENCIAS	WAARSCHUWINGEN	VARNINGAR
<ul style="list-style-type: none"> Avoid high temperatures. Allow for sufficient heat dispersion when installed in a rack. Handle the power cord carefully. Hold the plug when unplugging the cord. Keep the unit free from moisture, water, and dust. Unplug the power cord when not using the unit for long periods of time. Do not obstruct the ventilation holes. Do not let foreign objects into the unit. Do not let insecticides, benzene, and thinner come in contact with the unit. Never disassemble or modify the unit in any way. Ventilation should not be impeded by covering the ventilation openings with items, such as newspapers, tablecloths or curtains. Naked flame sources such as lighted candles should not be placed on the unit. Observe and follow local regulations regarding battery disposal. Do not expose the unit to dripping or splashing fluids. Do not place objects filled with liquids, such as vases, on the unit. Do not handle the mains cord with wet hands. When the switch is in the OFF position, the equipment is not completely switched off from MAINS. The equipment shall be installed near the power supply so that the power supply is easily accessible. 	<ul style="list-style-type: none"> Vermeiden Sie hohe Temperaturen. Beachten Sie, dass eine ausreichende Belüftung gewährleistet wird, wenn das Gerät auf ein Regal gestellt wird. Gehen Sie vorsichtig mit dem Netzkabel um. Halten Sie das Kabel am Stecker, wenn Sie den Stecker herausziehen. Halten Sie das Gerät von Feuchtigkeit, Wasser und Staub fern. Wenn das Gerät längere Zeit nicht verwendet werden soll, trennen Sie das Netzkabel vom Netzstecker. Decken Sie den Lüftungsbereich nicht ab. Lassen Sie keine fremden Gegenstände in das Gerät kommen. Lassen Sie das Gerät nicht mit Insektiziden, Benzin oder Verdünnungsmitteln in Berührung kommen. Versuchen Sie niemals das Gerät auseinander zu nehmen oder zu verändern. Die Belüftung sollte auf keinen Fall durch das Abdecken der Belüftungsöffnungen durch Gegenstände wie beispielsweise Zeitungen, Tischtücher, Vorhänge o. Ä. behindert werden. Auf dem Gerät sollten keinerlei direkte Feuerquellen wie beispielsweise angezündete Kerzen aufgestellt werden. Bitte beachten Sie bei der Entsorgung der Batterien die örtlich geltenden Umweltbestimmungen. Das Gerät sollte keiner tropfenden oder spritzenden Flüssigkeit ausgesetzt werden. Auf dem Gerät sollten keine mit Flüssigkeit gefüllten Behälter wie beispielsweise Vasen aufgestellt werden. Das Netzkabel nicht mit feuchten oder nassen Händen anfassen. Wenn der Schalter ausgeschaltet ist (OFF-Position), ist das Gerät nicht vollständig vom Stromnetz (MAINS) abgetrennt. Das Gerät sollte in der Nähe einer Netzsteckdose aufgestellt werden, damit es leicht an das Stromnetz angeschlossen werden kann. 	<ul style="list-style-type: none"> Eviter des températures élevées. Tenir compte d'une dispersion de chaleur suffisante lors de l'installation sur une étagère. Manipuler le cordon d'alimentation avec précaution. Tenir la prise lors du débranchement du cordon. Protéger l'appareil contre l'humidité, l'eau et la poussière. Débrancher le cordon d'alimentation lorsque l'appareil n'est pas utilisé pendant de longues périodes. Ne pas obstruer les trous d'aération. Ne pas laisser des objets étrangers dans l'appareil. Ne pas mettre en contact des insecticides, du benzène et un diluant avec l'appareil. Ne jamais démonter ou modifier l'appareil d'une manière ou d'une autre. Ne pas recouvrir les orifices de ventilation avec des objets tels que des journaux, nappes ou rideaux. Cela entraverait la ventilation. Ne jamais placer de flamme nue sur l'appareil, notamment des bougies allumées. Veillez à respecter les lois en vigueur lorsque vous jetez les piles usagées. L'appareil ne doit pas être exposé à l'eau ou à l'humidité. Ne pas poser d'objet contenant du liquide, par exemple un vase, sur l'appareil. Ne pas manipuler le cordon d'alimentation avec les mains mouillées. Lorsque l'interrupteur est sur la position OFF, l'appareil n'est pas complètement déconnecté du SECTEUR (MAINS). L'appareil sera installé près de la source d'alimentation, de sorte que cette dernière soit facilement accessible. 	<ul style="list-style-type: none"> Evitate di esporre l'unità a temperature elevate. Assicuratevi che vi sia un'adeguata dispersione del calore quando installate l'unità in un mobile per componenti audio. Manneggiate il cavo di alimentazione con attenzione. Tenete ferma la spina quando scollegate il cavo dalla presa. Tenete l'unità lontana dall'umidità, dall'acqua e dalla polvere. Scollegate il cavo di alimentazione quando prevedete di non utilizzare l'unità per un lungo periodo di tempo. Non coprite i fori di ventilazione. Non inserite corpi estranei all'interno dell'unità. Assicuratevi che l'unità non entri in contatto con insetticidi, benzolo o solventi. Non smontate né modificate l'unità in alcun modo. Le aperture di ventilazione non devono essere ostruite coprendole con oggetti, quali giornali, tovaglie, tende e così via. Non posizionate sull'unità fi amme libere, come ad esempio candele accese. Prestate attenzione agli aspetti legati alla tutela dell'ambiente nello smaltimento delle batterie. L'apparecchiatura non deve essere esposta a goccioli o spruzzi. Non posizionate sull'unità alcun oggetto contenente liquidi, come ad esempio i vasi. Non toccare il cavo di alimentazione con le mani bagnate. Quando l'interruttore è nella posizione OFF, l'apparecchiatura non è completamente scollegata da MAINS. L'apparecchio va installato in prossimità della fonte di alimentazione, in modo che quest'ultima sia facilmente accessibile. 	<ul style="list-style-type: none"> Evite altas temperaturas. Permita la suficiente dispersión del calor cuando está instalado en la consola. Maneje el cordón de energía con cuidado. Sostenga el enchufe cuando desconecte el cordón de energía. Mantenga el equipo libre de humedad, agua y polvo. Desconecte el cordón de energía cuando no utilice el equipo por mucho tiempo. No obstruya los orificios de ventilación. No deje objetos extraños dentro del equipo. No permita el contacto de insecticidas, gasolina y diluyentes con el equipo. Nunca desarme o modifique el equipo de ninguna manera. La ventilación no debe quedar obstruida por haberse cubierto las aperturas con objetos como periódicos, manteles o cortinas. No deberán colocarse sobre el aparato fuentes inflamables sin protección, como velas encendidas. A la hora de deshacerse de las pilas, respete la normativa para el cuidado del medio ambiente. No exponer el aparato al goteo o salpicaduras cuando se utilice. No colocar sobre el aparato objetos llenos de líquido, como jarras. No maneje el cable de alimentación con las manos mojadas. Quando el interruptor está en la posición OFF, el equipo no está completamente desconectado de la alimentación MAINS. El equipo se instalará cerca de la fuente de alimentación de manera que resulte fácil acceder a ella. 	<ul style="list-style-type: none"> Vermijd hoge temperaturen. Zorg er bij installatie in een audiorack voor, dat de door het toestel geproduceerde warmte goed kan worden afgevoerd. Hanteer het netsnoer voorzichtig. Houd het snoer bij de stekker vast wanneer deze moet worden aan- of losgekoppeld. Laat geen vochtigheid, water of stof in het apparaat binnendringen. Neem altijd het netsnoer uit het stopcontact wanneer het apparaat gedurende een lange periode niet wordt gebruikt. De ventilatieopeningen mogen niet worden beblokkeerd. Laat geen vreemde voorwerpen in dit apparaat vallen. Voorcom dat insecticiden, benzene of ververdunner met dit toestel in contact komen. Dit toestel mag niet gedemonteerd of aangepast worden. De ventilatie mag niet worden belemmerd door de ventilatieopeningen af te dekken met bijvoorbeeld kranten, een tafelkleed of gordijnen. Plaats geen open vlammen, bijvoorbeeld een brandende kaars, op het apparaat. Houd u steeds aan de milieuvoorschriften wanneer u gebruikte batterijen wegdoet. Stel het apparaat niet bloot aan druppels of spatten. Plaats geen voorwerpen gevuld met water, bijvoorbeeld een vaas, op het apparaat. Raak het netsnoer niet met natte handen aan. Als de schakelaar op OFF staat, is het apparaat niet volledig losgekoppeld van de netspanning (MAINS). De apparatuur wordt in de buurt van het stopcontact geïnstalleerd, zodat dit altijd gemakkelijk toegankelijk is. 	<ul style="list-style-type: none"> Undvik höga temperaturer. Se till att det finns möjlighet till god värmeavledning vid montering i ett rack. Hantera nätkabeln varsamt. Håll i kabeln när den kopplas från el-uttaget. Utsätt inte apparaten för fukt, vatten och damm. Koppla loss nätkabeln om apparaten inte kommer att användas i lång tid. Täpp inte till ventilationsöppningarna. Se till att främmande föremål inte tränger in i apparaten. Se till att inte insektsmedel på spraybruk, bensen och thinner kommer i kontakt med apparatens hölje. Ta inte isär apparaten och försök inte bygga om den. Ventilationen bör inte förhindras genom att täcka för ventilationsöppningarna med föremål såsom tidningar, bordsdukar eller gardiner. Placera inte öppen eld, t.ex. tända ljus, på apparaten. Tänk på miljöaspekterna när du bortskaffar batterier. Apparaten får inte utsättas för vätska. Placera inte föremål fyllda med vätska, t.ex. vaser, på apparaten. Hantera inte nätsladden med våta händer. Även om strömbrytaren står i det avstängda läget OFF, så är utrustningen inte helt bortkopplad från det elektriska nätet (MAINS). Utrustningen ska vara installerad nära strömuttaget så att strömförsörjningen är lätt att tillgå.

• DECLARATION OF CONFORMITY

We declare under our sole responsibility that this product, to which this declaration relates, is in conformity with the following standards: EN60065, EN55013, EN55020, EN61000-3-2 and EN61000-3-3. Following the provisions of Low Voltage Directive 2006/95/EC and EMC Directive 2004/108/EC, the EC regulation 1275/2008 and its frame work Directive 2009/125/EC for Energy-related Products (ErP).

• ÜBEREINSTIMMUNGSERKLÄRUNG

Wir erklären unter unserer Verantwortung, daß dieses Produkt, auf das sich diese Erklärung bezieht, den folgenden Standards entspricht: EN60065, EN55013, EN55020, EN61000-3-2 und EN61000-3-3. Following the provisions of low voltage directive 2006/95/EC and EMC directive 2004/108/EC, the EC regulation 1275/2008 and its frame work directive 2009/125/EC for energy-related products (ErP).

• DECLARATION DE CONFORMITE

Nous déclarons sous notre seule responsabilité que l'appareil, auquel se réfère cette déclaration, est conforme aux standards suivants: EN60065, EN55013, EN55020, EN61000-3-2 et EN61000-3-3. Selon la directive 2006/95/EC concernant la basse tension et la directive CEM 2004/108/EC, la réglementation européenne 1275/2008 et la directive 2009/125/EC établissant un cadre de travail applicable aux produits liés à l'énergie (ErP).

• DICHIARAZIONE DI CONFORMITÀ

Dichiariamo con piena responsabilità che questo prodotto, al quale la nostra dichiarazione si riferisce, è conforme alle seguenti normative: EN60065, EN55013, EN55020, EN61000-3-2 e EN61000-3-3. Facendo seguito alle disposizioni della direttiva sul basso voltaggio 2006/95/EC alla direttiva EMC 2004/108/EC, alla norma EC 1275/2008 e alla relativa legge quadro 2009/125/EC in materia di prodotti alimentari ad energia (ErP).

QUESTO PRODOTTO E' CONFORME
AL D.M. 28/08/95 N. 548

• DECLARACIÓN DE CONFORMIDAD

Declaramos bajo nuestra exclusiva responsabilidad que este producto al que hace referencia esta declaración, está conforme con los siguientes estándares: EN60065, EN55013, EN55020, EN61000-3-2 y EN61000-3-3. De acuerdo con la directiva sobre baja tensión 2006/95/CE y la directiva sobre CEM 2004/108/CE, la normativa CE 1275/2008 y su directiva marco 2009/125/EC para productos relacionados con la energía (ErP).

• EENVORMIGHEIDSVERKLARING

Wij verklaren uitsluitend op onze verantwoordelijkheid dat dit product, waarop deze verklaring betrekking heeft, in overeenstemming is met de volgende normen: EN60065, EN55013, EN55020, EN61000-3-2 en EN61000-3-3. Volgens de voorzieningen van lage spanningsrichtlijn 2006/95/EC en EMC-richtlijn 2004/108/EC, de EU-richtlijn 1275/2008 en de kaderrichtlijn 2009/125/EC voor energieverbruikende producten (ErP).

• ÖVERENSSTÄMMELSESINTYG

Härmed intygas helt på eget ansvar att denna produkt, vilken detta intyg avser, uppfyller följande standarder: EN60065, EN55013, EN55020, EN61000-3-2 och EN61000-3-3. Uppfyller reglerna i lågspanningsdirektivet 2006/95/EC och EMC-direktivet 2004/108/EC, EU-förordningen 1275/2008 och ramverksdirektivet 2009/125/EC för energirelaterade produkter (ErP).

DENON EUROPE
Division of D&M Germany GmbH
An der Kleinbahn 18, Nettetal,
D-41334 Germany

A NOTE ABOUT RECYCLING:

This product's packaging materials are recyclable and can be reused. Please dispose of any materials in accordance with the local recycling regulations. When discarding the unit, comply with local rules or regulations. Batteries should never be thrown away or incinerated but disposed of in accordance with the local regulations concerning battery disposal. This product and the supplied accessories, excluding the batteries, constitute the applicable product according to the WEEE directive.

HINWEIS ZUM RECYCLING:

Das Verpackungsmaterial dieses Produktes ist zum Recyceln geeignet und kann wieder verwendet werden. Bitte entsorgen Sie alle Materialien entsprechend der örtlichen Recycling-Vorschriften. Beachten Sie bei der Entsorgung des Gerätes die örtlichen Vorschriften und Bestimmungen.

Die Batterien dürfen nicht in den Hausmüll geworfen oder verbrannt werden; bitte entsorgen Sie die Batterien gemäß der örtlichen Vorschriften.

Dieses Produkt und das im Lieferumfang enthaltene Zubehör (mit Ausnahme der Batterien!) entsprechen der WEEE-Direktive.

UNE REMARQUE CONCERNANT LE RECYCLAGE:

Les matériaux d'emballage de ce produit sont recyclables et peuvent être réutilisés. Veuillez disposer des matériaux conformément aux lois sur le recyclage en vigueur.

Lorsque vous mettez cet appareil au rebut, respectez les lois ou réglementations en vigueur.

Les piles ne doivent jamais être jetées ou incinérées, mais mises au rebut conformément aux lois en vigueur sur la mise au rebut des piles.

Ce produit et les accessoires inclus, à l'exception des piles, sont des produits conformes à la directive DEEE.

NOTA RELATIVA AL RICICLAGGIO:

I materiali di imballaggio di questo prodotto sono riutilizzabili e riciclabili. Smaltire i materiali conformemente alle normative locali sul riciclaggio.

Per lo smaltimento dell'unità, osservare le normative o le leggi locali in vigore.

Non gettare le batterie, né incenerirle, ma smaltirle conformemente alla normativa locale sui rifiuti chimici.

Questo prodotto e gli accessori inclusi nell'imballaggio sono applicabili alla direttiva RAEE, ad eccezione delle batterie.

ACERCA DEL RECICLAJE:

Los materiales de embalaje de este producto son reciclables y se pueden volver a utilizar. Disponga de estos materiales siguiendo los reglamentos de reciclaje de su localidad.

Cuando se deshaga de la unidad, cumpla con las reglas o reglamentos locales.

Las pilas nunca deberán tirarse ni incinerarse. Deberá disponer de ellas siguiendo los reglamentos de su localidad relacionados con los desperdicios químicos.

Este producto junto con los accesorios empaquetados es el producto aplicable a la directiva RAEE excepto pilas.

EEN AANTEKENING MET BETREKKING TOT DE RECYCLING:

Het inpakmateriaal van dit product is recycleerbaar en kan opnieuw gebruikt worden. Er wordt verzocht om zich van elk afvalmateriaal te ontdoen volgens de plaatselijke voorschriften.

Volg voor het wegdoen van de speler de voorschriften voor de verwijdering van wit- en bruingoed op.

Batterijen mogen nooit worden weggegooid of verbrand, maar moeten volgens de plaatselijke voorschriften betreffende chemisch afval worden verwijderd.

Op dit product en de meegeleverde accessoires, m.u.v. de batterijen is de richtlijn voor afgedankte elektrische en elektronische apparaten (WEEE) van toepassing.

OBSERVERA ANGÅENDE ÅTERVINNING:

Produktens emballage är återvinningsbart och kan återanvändas. Kassera det enligt lokala återvinningsbestämmelser.

När du kasserar enheten ska du göra det i överensstämmelse med lokala regler och bestämmelser. Batterier får absolut inte kastas i soporna eller brännas. Kassera dem enligt lokala bestämmelser för kemiskt avfall.

Denna apparat och de tillbehör som levereras med den uppfyller gällande WEEE-direktiv, med undantag av batterierna.



Pb

**CAUTIONS ON INSTALLATION
VORSICHTSHINWEISE ZUR AUFSTELLUNG
PRÉCAUTIONS D'INSTALLATION
PRECAUZIONI SULL'INSTALLAZIONE
EMPLAZAMIENTO DE LA INSTALACIÓN
VOORZORGSMAATREGELEN BIJ DE
INSTALLATIE
FÖRSIKTIGHET VID INSTALLATIONEN**

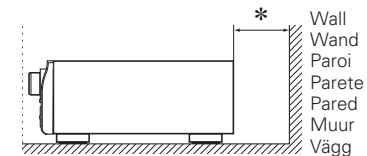
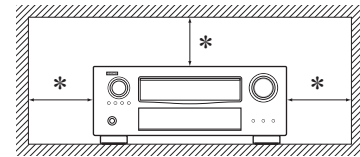

Wall
Wand
Pari
Parete
Pared
Muur
Vägg

* For proper heat dispersal, do not install this unit in a confined space, such as a bookcase or similar enclosure.

- More than 0.3 m is recommended.
- Do not place any other equipment on this unit.

* Stellen Sie das Gerät nicht an einem geschlossenen Ort, wie in einem Bücherregal oder einer ähnlichen Einrichtung auf, da dies eine ausreichende Belüftung des Geräts behindern könnte.

- Empfohlen wird über 0,3 m.
- Keine anderen Gegenstände auf das Gerät stellen.

* Pour permettre la dissipation de chaleur requise, n'installez pas cette unité dans un espace confiné tel qu'une bibliothèque ou un endroit similaire.

- Une distance de plus de 0,3 m est recommandée.
- Ne placez aucun matériel sur cet appareil.

* Per una dispersione adeguata del calore, non installare questa apparecchiatura in uno spazio ristretto, come ad esempio una libreria o simili.

- Si raccomanda una distanza superiore ai 0,3 m.
- Non posizionare alcun altro oggetto o dispositivo su questo dispositivo.

* Para la dispersión del calor adecuadamente, no instale este equipo en un lugar confinado tal como una librería o unidad similar.

- Se recomienda dejar más de 0,3 m alrededor.
- No coloque ningún otro equipo sobre la unidad.

* Plaats dit toestel niet in een kleine afgesloten ruimte, zoals een boekenkast e.d., omdat anders de warmte niet op gepaste wijze kan worden afgevoerd.

- Meer dan 0,3 m is aanbevolen.
- Plaats geen andere apparatuur op het toestel.

* För att tillförsäkra god värmeavledning får utrustningen inte installeras i instängda utrymmen, som t.ex. en bokhylla eller liknande.

- Mer än 0,3 m rekommenderas.
- Placera ingen annan utrustning ovanpå den här enheten.

Getting started

Thank you for purchasing this DENON product. To ensure proper operation, please read these owner's manual carefully before using the product.

After reading them, be sure to keep them for future reference.

Contents

Getting started	1
Accessories	1
About this manual	1
Features	2
Cautions on handling	2
Simple version (Simple setup guide)	3
Basic version	12
Connections	13
Important information	13
Connecting an HDMI-compatible device	14
Connecting a TV	16
Connecting a Blu-ray Disc player	16
Connecting a DVD player	17
Connecting a set-top box (Satellite tuner/cable TV)	17
Connecting a digital video recorder	18
Connecting a digital camcorder	18
Connecting a control dock for iPod	19
Connecting an iPod or USB memory device to the USB port	19
Connecting an antenna	20
Connecting a record player	20
Connecting a CD player	21
Connecting an external power amplifier	21
Connecting to a home network (LAN)	22
Connecting an external control device	23
Playback (Basic operation)	24
Important information	24
Playing a Blu-ray Disc player/DVD player	25
Playing a CD player	25
Playing an iPod®	25
Tuning in radio stations	28
Playing a network audio	30
Playing a USB memory device	38
Selecting a listening mode (Surround mode)	40
Standard playback	40
DENON original surround playback	42
Stereo playback	42
Direct playback	42
Pure direct playback	42

Advanced version43

Speaker installation/connection (Advanced connection)	44
Install	44
Connect	45
Set up speakers	48
Playback (Advanced operation)	50
Convenient functions	50
Playback in ZONE2/ZONE3 (Separate room)	57
Audio output	57
Video output	57
Playback	58
Quick select function	58
How to make detailed settings	59
Menu map	59
Examples of menu and front display	60
Inputting characters	61
Input Setup	63
Audio/Video Adjust	68
Manual Setup	74
Information	86
Operating the connected devices by remote control unit	87
Operating the main remote control unit	87
Operating the sub remote control unit	91

Information94

Part names and functions	95
Front panel	95
Display	96
Rear panel	97
Remote control unit	98
Other information	100
Trademark information	100
Surround	101
Relationship between video signals and monitor output	105
Explanation of terms	106
Troubleshooting	108
Resetting the microprocessor	111
Specifications	112

Accessories

Check that the following parts are supplied with the product.

① Owner's manual	1
② Service network list	1
③ Power cord (Cord length: Approx. 1.8 m)	1
④ Main remote control unit (RC-1146)	1
⑤ R6/AA batteries (for RC-1146)	2
⑥ Sub remote control unit (RC-1148)	1
⑦ R03/AAA batteries (for RC-1148)	2
⑧ Setup microphone (DM-A409, Cord length: Approx. 6.0 m)	1
⑨ AM loop antenna	1
⑩ FM indoor antenna	1

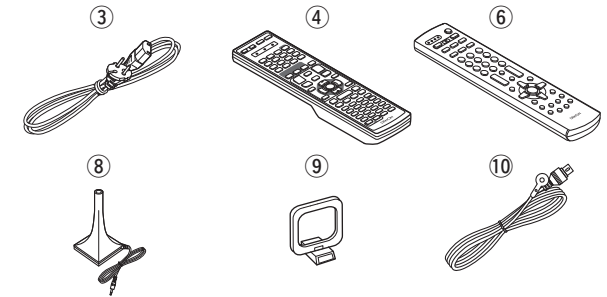

About this manual

❑ Operation buttons

The operations described in this manual are based mainly on remote control operation.

❑ Symbols



This symbol indicates a reference page on which related information is described.



This symbol indicates a supplementary information and tips for operations.

NOTE

This symbol indicates a supplementary information and tips for operations.

❑ Illustrations

Note that the illustrations in these instructions are for explanation purposes and may differ from the actual unit.

Features

Fully Discrete, identical quality and power for all 7 channels (165 W x 7ch)

The unit is equipped with a power amplifier that reproduces high-fidelity sound in surround mode with equal quality and power for all channels, true to the original sound.

The power amplifier circuit adopts a discrete-circuit configuration that achieves high-quality surround sound reproduction.

Supports HDMI 1.4a with 3D, ARC, Deep Color, x.v.Color, Auto Lipsync and HDMI control function

This unit can output 3D video signals input from a Blu-ray Disc player to a TV that supports a 3D system. This unit also supports the ARC (Audio Return Channel) function, which reproduces TV sound with this unit via an HDMI cable used for connecting the unit and a TV*1.

*1 The TV should support the ARC function.

Internet radio, music and photo streaming via network*2

This unit can playback audio files and still images such as photographs that are stored on your computer via a network. You can also listen to internet radio and a whole host of other online music*3 that uses network technology.

*2 An internet connection is required.

*3 You may be required to sign a service agreement with the companies that provide particular services.

6-HDMI inputs and 2-outputs

The unit is equipped with 6 HDMI input connectors for connecting devices with HDMI connectors, such as a Blu-ray Disc player, game machine, HD video camera, etc.

High definition audio support

The unit is equipped with a decoder which supports high-quality digital audio format for Blu-ray Disc players such as Dolby TrueHD, DTS-HD Master Audio, etc.

Audyssey DSX™

This unit is equipped with an Audyssey DSX decoder. By connecting front height speakers to this unit and playing back through Audyssey DSX, you can experience a more powerful playback expression in the height audio range. By connecting front wide speakers, you can experience a more powerful playback expression in the wide audio range.

Easy to use, Graphical User Interface

This unit is equipped with an easy to see "Graphical User Interface" that uses menu displays and levels. The use of level displays increases operability of the unit.

All sources are up-scaled to 1080p

The unit is provided with an HDMI video up-scaling function that converts an analog video signal input to the unit to a 1080p (HD resolution) signal and supplies it to a TV via the HDMI connector. This enables the unit and a TV connected with a single HDMI cable and any video source to be reproduced precisely with HD level of quality.

Direct play for iPod® and iPhone® via USB

Music data from an iPod can be played back if you connect the USB cable supplied with the iPod via the USB port of this unit, and also an iPod can be controlled with the remote control unit for this unit.

When an iPod is connected, merely pressing **iPod PLAY** on the main unit or remote control unit starts playback of music from the iPod.

Cautions on handling

• Before turning the power switch on

Check once again that all connections are correct and that there are no problems with the connection cables.

- Power is supplied to some of the circuitry even when the unit is set to the standby mode. When going on vacation or leaving home for long periods of time, be sure to unplug the power cord from the power outlet.

• About condensation

If there is a major difference in temperature between the inside of the unit and the surroundings, condensation (dew) may form on the operating parts inside the unit, causing the unit not to operate properly.

If this happens, let the unit sit for an hour or two with the power turned off and wait until there is little difference in temperature before using the unit.

• Cautions on using mobile phones

Using a mobile phone near this unit may result in noise. If that occurs, move the mobile phone away from this unit when it is in use.

• Moving the unit

Turn off the power and unplug the power cord from the power outlet. Next, disconnect the connection cables to other system units before moving the unit.

• About Care

- Wipe the cabinet and control panel clean with a soft cloth.
- Follow the instructions when using a chemical cleaner.
- Benzene, paint thinner or other organic solvents as well as insecticide may cause material changes and discoloration if brought into contact with the unit, and should therefore not be used.

Simple version (Simple setup guide)

Here, we explain the entire setup procedure, from unboxing the unit to using it in a home theater. The "Simple version" section provides the speaker installation, connection, and setup methods for the 7.1-channel system with surround back speakers. For the installing, connecting, and setup methods of speakers other than the 7.1-channel system (with surround back speakers), see page 44.

- ❑ Before connecting the unit, turn off the power to all devices.
- ❑ For operation of the connected devices, refer to the user manuals for each device.

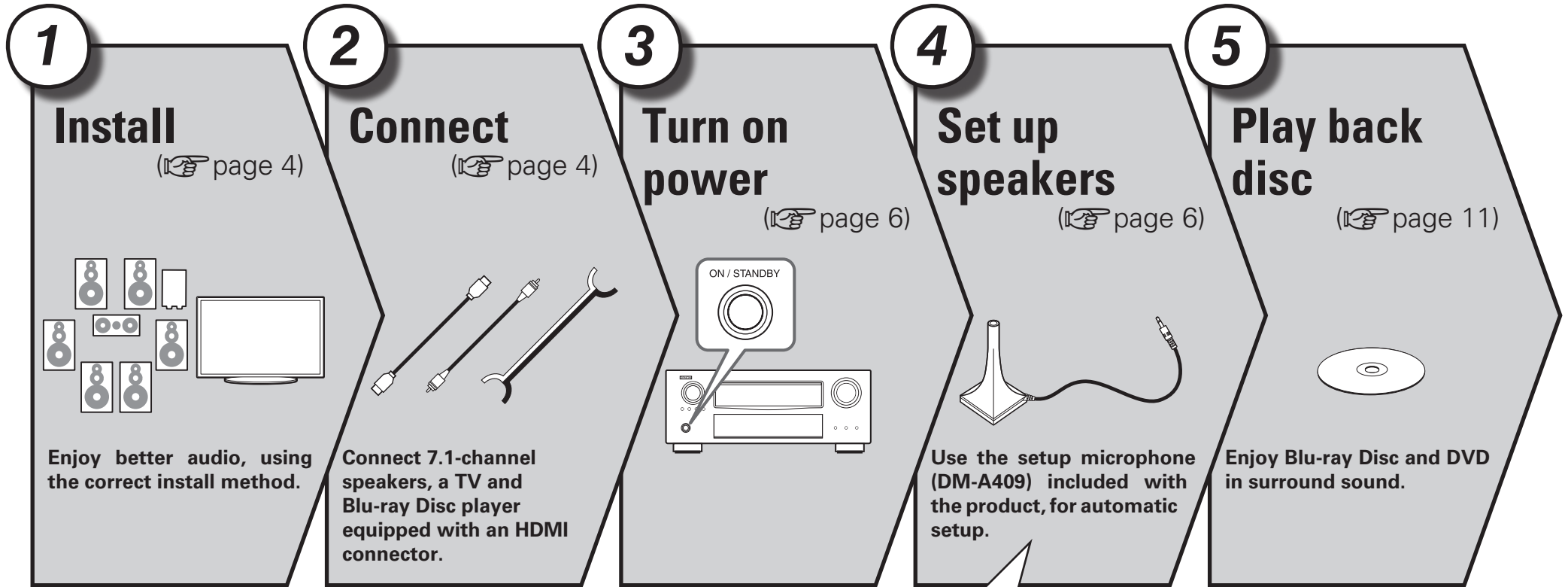

Set up speakers (Audyssey® Auto Setup)

STEP 1
Preparation

STEP 2
Speaker
Detection

STEP 3
Measurement

STEP 4
Calculation

STEP 5
Check

STEP 6
Store

Finish

1 Install



This unit can perform 2.0/2.1 to 7.1-channel surround playback. This page provides the speaker installation procedure for the 7.1-channel playback using surround back speakers as an example.

The default setting is 7.1-channel. You can also perform 5.1-channel playback. To perform 5.1-channel playback, connect 5.1-channel speakers only. Use the Audyssey Auto Setup function of this unit to automatically detect the number of connected speakers and perform optimal settings for the speakers to be used.

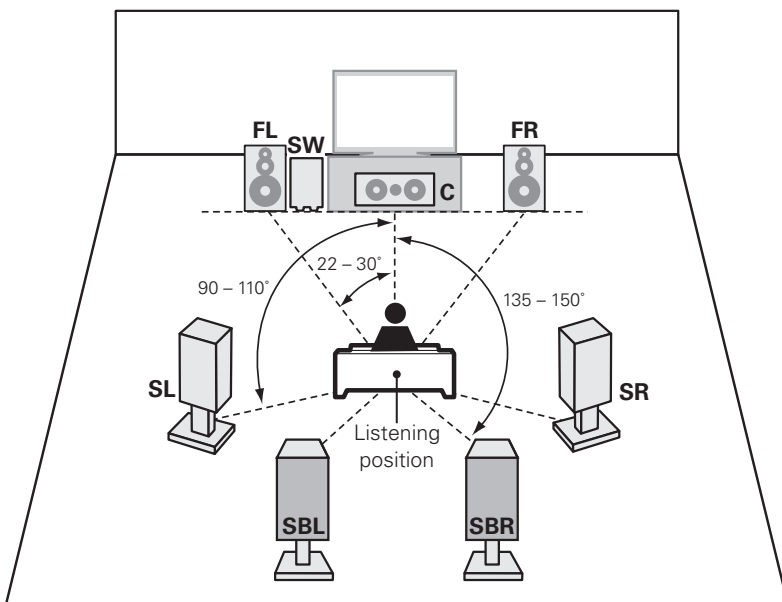

- FL Front speaker (L)
- FR Front speaker (R)
- C Center speaker
- SW Subwoofer
- SL Surround speaker (L)
- SR Surround speaker (R)
- SBL Surround back speaker (L)
- SBR Surround back speaker (R)

- Install the surround speakers in a position 60 to 90 cm higher than ear level.

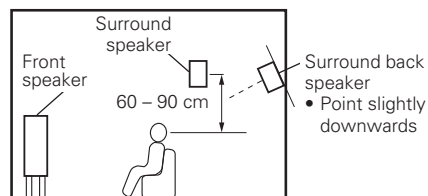

[Viewed from the side]

2 Connect



Speakers

Carefully check the left (L) and right (R) channels and + (red) and - (black) polarities on the speakers being connected to the this unit, and be sure to interconnect the channels and polarities correctly.

NOTE

- Connect so that the speaker cable core wires do not protrude from the speaker terminal. The protection circuit may be activated if the core wires touch the rear panel or if the + and - sides touch each other (see page 107 "Protection Circuit").
- Never touch the speaker terminals while the power supply is connected. Doing so could result in electric shock.
- Use speakers with the speaker impedances shown below.

Connecting the speaker cables

Peel off about 10 mm of sheathing from the tip of the speaker cable, then either twist the core wire tightly or terminate it.

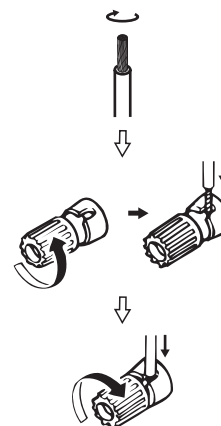

Speaker terminals	Speaker impedance
FRONT	6 - 16 Ω
CENTER	
SURROUND	
SURR. BACK / AMP ASSIGN	
F.HEIGHT	
F.WIDE	

The "Simple version" section provides the speaker installation, connection, and setup methods for the 7.1-channel system with surround back speakers. For the installing, connecting, and setup methods of speakers other than the 7.1-channel system (with surround back speakers), see page 44.

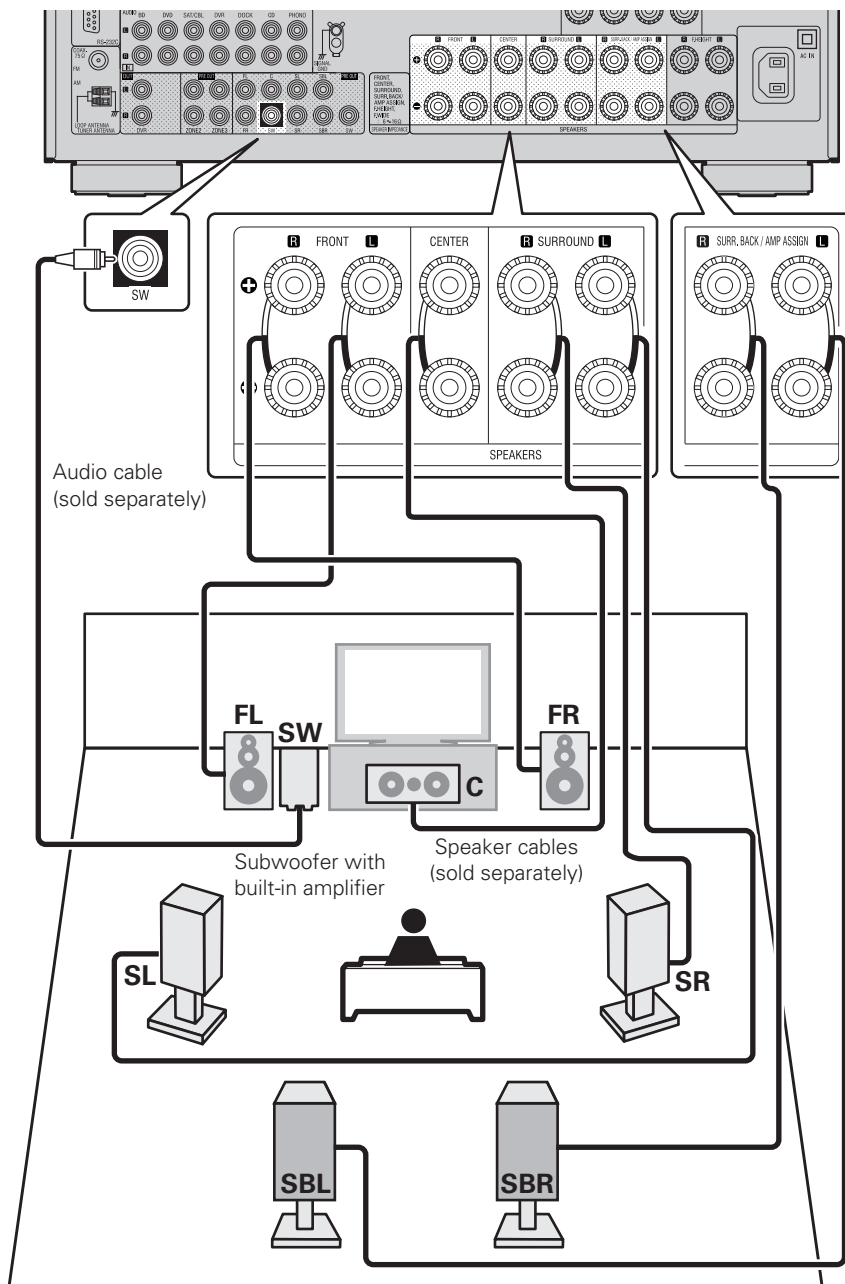

Blu-ray Disc player and TV

Use only an HDMI (High Definition Multimedia Interface) cable that bears the HDMI logo (a genuine HDMI product). Using a cable without the HDMI logo (a non-genuine HDMI product) may result in abnormal playback. When outputting Deep Color or 1080p, etc., we recommend you use a "High Speed HDMI cable" or a "High Speed HDMI cable with Ethernet" for enhanced high-quality playback.

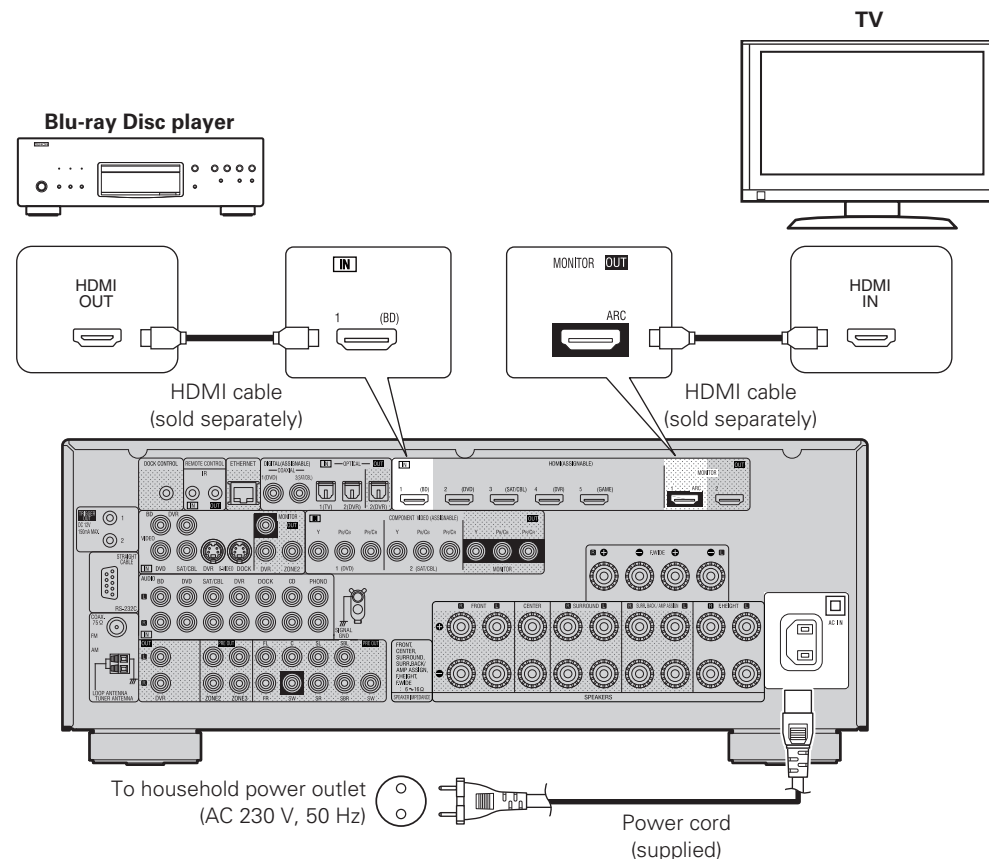

NOTE

- Do not plug in the power cord until all connections have been completed.
- Do not bundle power cords together with connection cables. Doing so can result in humming or noise.

The "Simple version" section provides the speaker installation, connection, and setup methods for the 7.1-channel system with surround back speakers. For the installing, connecting, and setup methods of speakers other than the 7.1-channel system (with surround back speakers), see page 44.

3 Turn on power



- 1** Turn on the TV and subwoofer power.

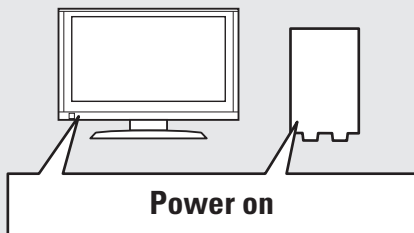

- 2** Change the TV input to the input of this unit.

- 3** Press **POWER ON** to turn on power to the unit.

The power indicator flashes green and the power turns on.

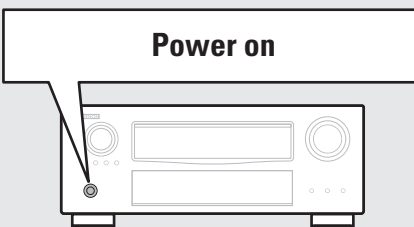
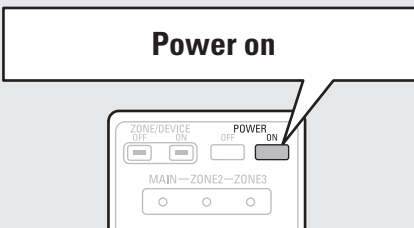

4 Set up speakers (Audyssey® Auto Setup)



The acoustic characteristics of the connected speakers and listening room are measured and the optimum settings are made automatically. This is called “Audyssey Auto Setup”.

To perform measurement, place the setup microphone in multiple locations all around the listening area. For best results, we recommend you measure in six or more positions, as shown in the illustration (up to eight positions).

- When performing Audyssey Auto Setup, MultEQ® XT/Dynamic EQ®/Dynamic Volume® functions become active (☞ page 71, 72).
- To set up the speakers manually, use “Speaker Setup” (☞ page 75) on the menu.

NOTE

- Make the room as quiet as possible. Background noise can disrupt the room measurements. Close windows, silence cell phones, televisions, radios, air conditioners, fluorescent lights, home appliances, light dimmers, or other devices as measurements may be affected by these sounds.
- Cell phones should be placed away from all audio electronics during the measurement process as Radio Frequency Interference (RFI) may cause measurement disruptions (even if the cell phone is not in use).
- Do not unplug the setup microphone from the main unit until Audyssey Auto Setup is completed.
- Do not stand between the speakers and setup microphone or allow obstacles in the path while the measurements are being made. This will cause inaccurate readings.
- Loud test sounds may be played during Audyssey Auto setup. This is part of normal operation. If there is background noise in room, these test signals will increase in volume.
- Operating **VOL ▲▼** during the measurements will cancel the measurements.
- Measurement cannot be performed when headphones are connected.

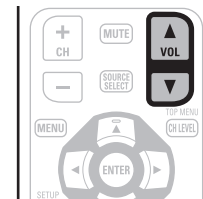

About setup microphone placement

- Measurements are performed by placing the setup microphone successively at multiple positions throughout the entire listening area, as shown in [Example ①]. For best results, we recommend you measure in six or more positions, as shown in the illustration (up to eight positions).
- Even if the listening environment is small as shown in [Example ②], measuring at multiple points throughout the listening environment results in more effective correction.

[Example ①]

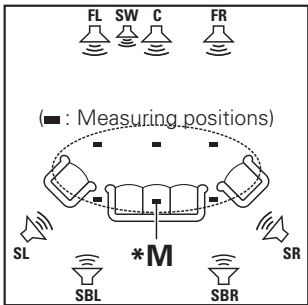

[Example ②]

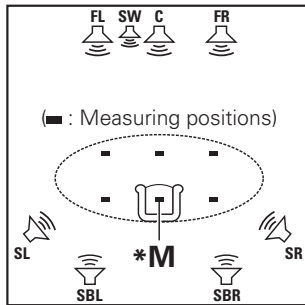

- FL** Front speaker (L)
- FR** Front speaker (R)
- C** Center speaker
- SW** Subwoofer

- SL** Surround speaker (L)
- SR** Surround speaker (R)
- SBL** Surround back speaker (L)
- SBR** Surround back speaker (R)

About the main listening position (*M)

The main listening position is the position where listeners would normally sit or where one would normally sit alone within the listening environment. Before starting Audyssey Auto Setup, place the setup microphone in the main listening position. Audyssey MultEQ® XT uses the measurements from this position to calculate speaker distance, level, polarity, and the optimum crossover value for the subwoofer.

1 Prepare the setup microphone

Mount the setup microphone on a tripod or stand and place it in the main listening position.

When placing the setup microphone, adjust the height of the sound receptor to the level of the listener's ear.

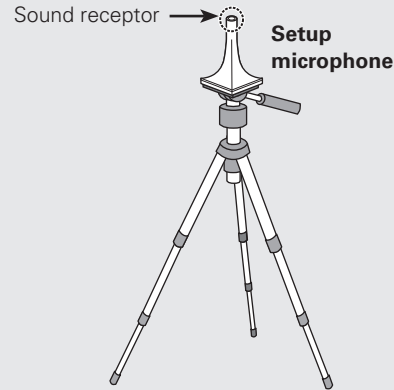

NOTE

- Do not hold the setup microphone in your hand during measurements.
- Avoid placing the setup microphone close to a seat back or wall as sound reflections may give inaccurate results.

2 Set up the subwoofer

If using a subwoofer capable of the following adjustments, set up the subwoofer as shown below.

- When using a subwoofer with a direct mode**
Set the direct mode to "On" and disable the volume adjustment and crossover frequency setting.
- When using a subwoofer without a direct mode**
Make the following settings:
 - **Volume** : "12 o'clock position"
 - **Crossover frequency** : "Maximum/Highest Frequency"
 - **Low pass filter** : "Off"
 - **Standby mode** : "Off"

NOTE

When you use two subwoofers, please adjust the subwoofer volume controls individually so that each subwoofer level is as close as possible to 75 dB using the test tone (page 76) before Audyssey Auto Setup.

3 Set up the remote control unit

- Set up the zone mode**
Press **ZONE SELECT** to switch the zone mode to "MAIN".
The "MAIN" indicator lights.

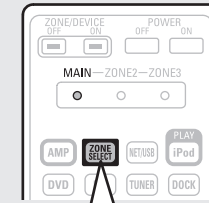

Press ZONE SELECT

- Set up the operation mode**
Press **AMP** to set the remote control unit to amplifier operation mode.

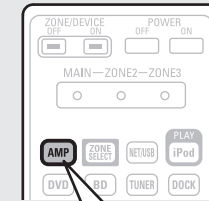

Press AMP

The "Simple version" section provides the speaker installation, connection, and setup methods for the 7.1-channel system with surround back speakers. For the installing, connecting, and setup methods of speakers other than the 7.1-channel system (with surround back speakers), see page 44.

Set up speakers (Audyssey® Auto Setup)

STEP 1
Preparation

4 Connect the setup microphone to the **SETUP MIC** jack of this unit.

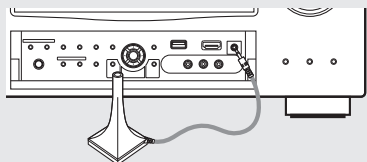

When the setup microphone is connected, the following screen is displayed.

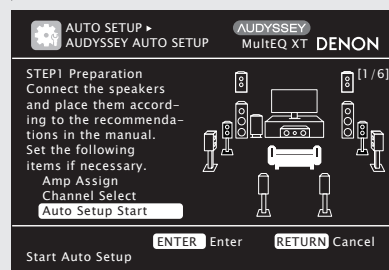

This screen provides the method for setting up 7.1-channel playback using surround back speakers. For the method of setting up speakers other than the 7.1-channel system, select "Amp Assign" and perform step 3 and 4 of "Set up "Amp Assign"" (page 49). If unused channels are set with "Channel Select", measuring time can be shortened. For setting, perform steps 5 to 10 of "Set up "Channel Select"" (page 49).

5 Use Δ ∇ to select "Auto Setup Start" and then press **ENTER**.

STEP 2
Speaker Detection

- In STEP 2, you will perform measurements at the main listening position.
- This step automatically checks the speaker configuration and speaker size, and calculates the channel level, distance, and crossover frequency. It also corrects distortion in the listening area.

6 Select "Measure" and then press **ENTER**.

When measuring begins, a test tone is output from each speaker.

- Measurement requires several minutes.

7 The detected speakers are displayed.

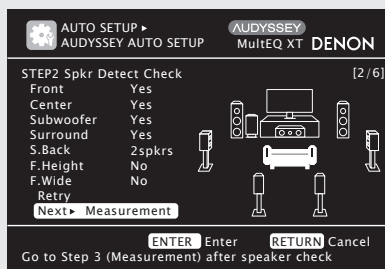

NOTE

If a connected speaker is not displayed, the speaker may not be connected correctly. Check the speaker connection.

8 Use Δ ∇ to select "Next ► Measurement" and then press **ENTER**.

NOTE

If "Caution" is displayed:

Go to "Error messages" (page 10), check any related items, and perform the necessary procedures.

If the problem is resolved, return and restart "Audyssey Auto Setup".

When performing Audyssey Auto Setup over again

Press Δ ∇ to select "Retry", and then press **ENTER**.

When measuring has stopped

Press **RETURN**, to the "Cancel Auto Setup?" prompt is displayed.

Press \triangleleft to select "Yes", then press **ENTER**.

Setting up the speakers again

Repeat the operation from step 4 of

STEP1 Preparation

STEP 3
Measurement

- In STEP 3, you will perform measurements at multiple positions (two to eight positions) other than the main listening position.
- You can achieve a more effective correction of distortion within the listening area by performing measurements at multiple positions.

9 Move the setup microphone to position 2, use Δ ∇ to select "Measure", and then press **ENTER**.

The measurement of the second position starts. Measurements can be made in up to eight positions.

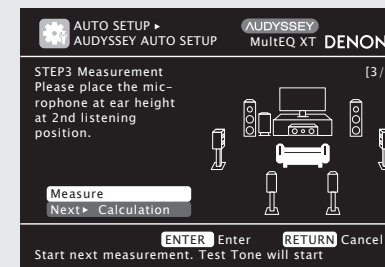

If you want to omit measurements from the next position onward, select "Next ► Calculation". (Go to **STEP4 Calculation**)

10 Repeat step 9, measuring positions 3 to 8.

When measurement of position 8 is completed, a "Measurements finished." message is displayed.

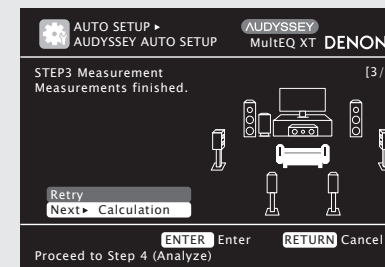

STEP 4 Calculation

11 On the **STEP3** screen, use \triangle / ∇ to select “Next \blacktriangleright Calculation”, and then press **ENTER**.

Measuring results are analyzed, and the frequency response of each speaker in the listening room is determined.

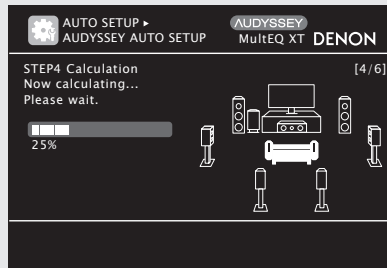

- Analysis takes several minutes to complete. The time required for this analysis depends on the number of speakers connected. The more connected speakers there are, the longer it takes to perform analysis.

STEP 5 Check

12 Use \triangle / ∇ to select the item you want to check, and then press **ENTER**.

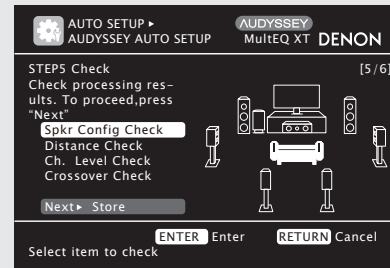

- Subwoofers may measure a greater reported distance than the actual distance due to added electrical delay common in subwoofers.
- If you want to check another item, press **RETURN**.

13 Use \triangle / ∇ to select “Next \blacktriangleright Store” and then press **ENTER**.

NOTE

- If the result differs from the actual connection status, or if “Caution!” is displayed, see “Error messages” (page 10). Then carry out Audyssey Auto Setup again.
- If the result still differs from the actual connection status after remeasurement or the error message still appears, it is possible that the speakers are not connected properly. Turn this unit off, check the speaker connections and repeat the measurement process from the beginning.
- If you change speaker positions or orientation, perform Audyssey Auto Setup again to find the optimal equalizer settings.

STEP 6 Store

14 Select “Store” and then press **ENTER**. Save the measurement results.

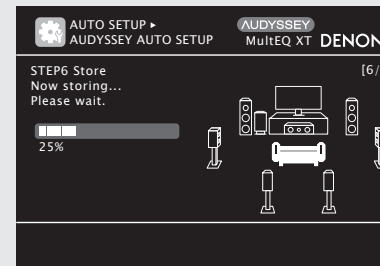

- Saving the results requires about 10 seconds.
- If the measuring results are not to be saved, press **RETURN**. A message “Cancel Auto Setup?” will be displayed. Press \triangleleft then select “Yes”. All the measured Audyssey Auto Setup data will be erased.

NOTE

During saving of measurement results, be sure not to turn off the power.

Finish

15 Unplug the setup microphone from the unit’s SETUP MIC jack.

16 Set Dynamic Volume®.

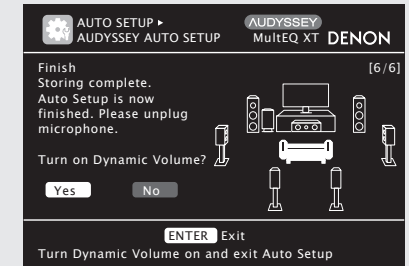

- For details of Dynamic Volume settings, see page 72.
- When turning Dynamic Volume on**
Use \triangleleft to select “Yes”, and then press **ENTER**.
 - The unit automatically enters “Evening” mode.
- When turning Dynamic Volume off**
Use \blacktriangleright to select “No”, and then press **ENTER**.

NOTE

After performing Audyssey Auto Setup, do not change the speaker connections or subwoofer volume. In event of a change, perform Audyssey Auto Setup again.



Error messages

An error message is displayed if Audyssey® Auto Setup could not be completed due to speaker placement, the measurement environment, etc. If this happens, check the relevant items, be sure to take the necessary measures, then perform Audyssey Auto Setup over again.

NOTE

Be sure to turn off the power before checking speaker connections.

Examples	Error details	Measures
<p>AUTO SETUP ▶ AUDYSSEY AUTO SETUP AUDYSSEY MultEQ XT DENON Caution! No microphone or Speaker Retry Check cause of problem! RETURN Cancel</p>	<ul style="list-style-type: none"> The connected setup microphone is broken, or a device other than the supplied setup microphone is connected. Not all speakers could be detected. The front L speaker was not properly detected. 	<ul style="list-style-type: none"> Connect the included setup microphone to the SETUP MIC jack of this unit. Check the speaker connections.
<p>AUTO SETUP ▶ AUDYSSEY AUTO SETUP AUDYSSEY MultEQ XT DENON Caution! Ambient noise is too high or Level is too low Retry Check cause of problem! RETURN Cancel</p>	<ul style="list-style-type: none"> There is too much noise in the room for accurate measurements to be made. Speaker or subwoofer sound is too low for accurate measurements to be made. 	<ul style="list-style-type: none"> Either turn off any device generating noise or move it away. Perform again when the surroundings are quieter. Check the speaker installation and the direction in which the speakers are facing. Adjust the subwoofer's volume.
<p>AUTO SETUP ▶ AUDYSSEY AUTO SETUP AUDYSSEY MultEQ XT DENON Caution! Front R None Retry Check cause of problem! RETURN Cancel</p>	<ul style="list-style-type: none"> The displayed speaker could not be detected. 	<ul style="list-style-type: none"> Check the connections of the displayed speaker.
<p>AUTO SETUP ▶ AUDYSSEY AUTO SETUP AUDYSSEY MultEQ XT DENON Caution! Front L Phase Retry Skip Check cause of problem! RETURN Cancel</p>	<ul style="list-style-type: none"> The displayed is connected with the polarities reversed. 	<ul style="list-style-type: none"> Check the polarities of the displayed speaker. For some speakers, this error message may be displayed even if the speaker is properly connected. If you are sure the connection is correct, press $\Delta \nabla$ to select "Skip", then press ENTER.

Parameter Check

This function enables you to check the measurement results and equalizer characteristics after Audyssey Auto Setup.

1 Use $\Delta \nabla$ to select "Parameter Check" and then press **ENTER** or \triangleright .

2 Use $\Delta \nabla$ to select the item you want to check, then press **ENTER** or \triangleright .

Measurement results for each speaker are displayed.

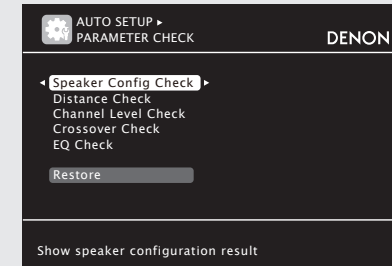

- Speaker Config. Check** Check the speaker configuration.
- Distance Check** Check the distance.
- Channel Level Check** Check the channel level.
- Crossover Check** Check the crossover frequency.
- EQ Check** Check the equalizer.

• If "EQ Check" is selected in step 2, press $\Delta \nabla$ to select equalizing curve ("Audyssey" or "Audyssey Flat") to be checked. Use $\triangleleft \triangleright$ to switch the display between the different speakers.

3 Press **RETURN**.
The confirmation screen reappears. Repeat steps 2.

Retrieving Audyssey Auto Setup settings

If you set "Restore" to "Yes", you can return to Audyssey Auto Setup measurement result (value calculated at the start by MultEQ® XT) even when you have changed each setting manually.



5 Play back disc



1 Press **BD** to switch an input source for a player used for playback.

2 Play the component connected to this unit.
Make the necessary settings on the player (language setting, subtitles setting, etc.) beforehand.

3 Adjust the sound volume.
VOL ▲ Volume up
VOL ▼ Volume down
MUTE Muting

4 Set the listening mode.
Set the listening mode according to the playback contents (cinema, music, etc.) or according to your liking (page 40 "Selecting a listening mode (Surround mode)").

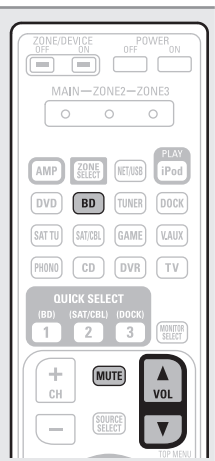

When power is switched to standby

Press **POWER OFF**.

[Power indicator status in standby mode]

- Normal standby : Off
- When "HDMI Control" is set to "ON" : Red
- When "Network Standby" is set to "ON" : Red

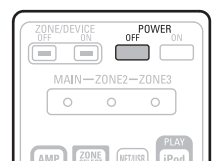

You can also switch the power to standby by pressing **ON/STANDBY** on the main unit.

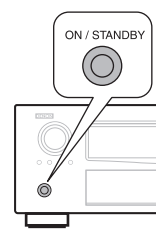

NOTE

During power standby, a minimal amount of power is consumed. To totally cut off the power, remove the power cord from the power outlet.

Simple version



Basic version

Advanced version























Information

Basic version

Here, we explain the connections and basic operation methods for this unit.

- **Connections**  page 13
- **Playback (Basic operation)**  page 24
- **Selecting a listening mode (Surround mode)**  page 40

Refer to the pages indicated below for information on connecting and playing back the various media and external devices.

Audio and Video	Connection	Playback
TV	 page 15, 16	-
Blu-ray Disc player	 page 15, 16	 page 25
DVD player	 page 15, 17	 page 25
Set-top box (Satellite tuner or cable TV)	 page 15, 17	-
Digital video recorder	 page 15, 18	-
Game console	 page 15	-
Digital camcorder	 page 18	-
Control dock for iPod	 page 19	 page 25
Audio	Connection	Playback
iPod®	 page 19	 page 27
USB memory device	 page 19	 page 38
CD player	 page 21	 page 25
Radio	 page 20	 page 28
Record player	 page 20	-
Network	Connection	Playback
Network	 page 22	 page 30

For speaker connections, see page 4.

Connections

Important information

- Make connections as follows before using this unit. Select an appropriate connection type according to the components to be connected.
- You may need to make some settings on this unit depending on the connection method. Refer to each description for more information.
- Select the cables (sold separately) according to the components being connected.

NOTE

- Do not plug in the power cord until all connections have been completed.
- When making connections, also refer to the operating instructions of the other components being connected.
- Be sure to connect the left and right channels properly (left with left, right with right).
- Do not bundle power cords together with connection cables. Doing so can result in noise.

Converting input video signals for output (Video conversion function)

This unit is equipped with four types of video input connectors (HDMI, Component video, S-Video and video) and three types of video output connectors (HDMI, Component video and video). Use the connectors corresponding to the components to be connected. This function automatically converts various formats of video signals input to this unit into the formats used to output the video signals from this unit to a monitor.

[Flow of video signals for MAIN ZONE]

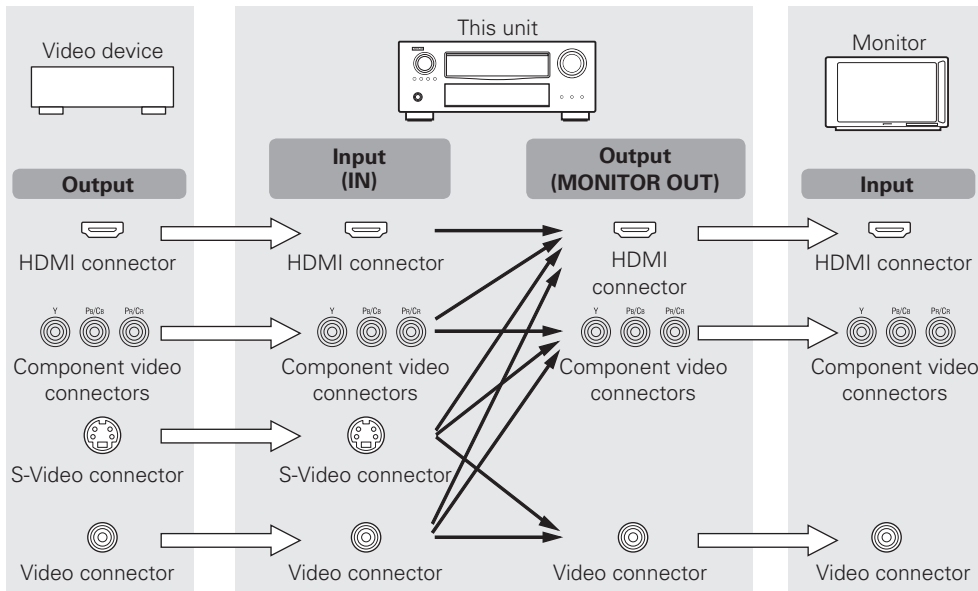

[Flow of video signals for ZONE2]

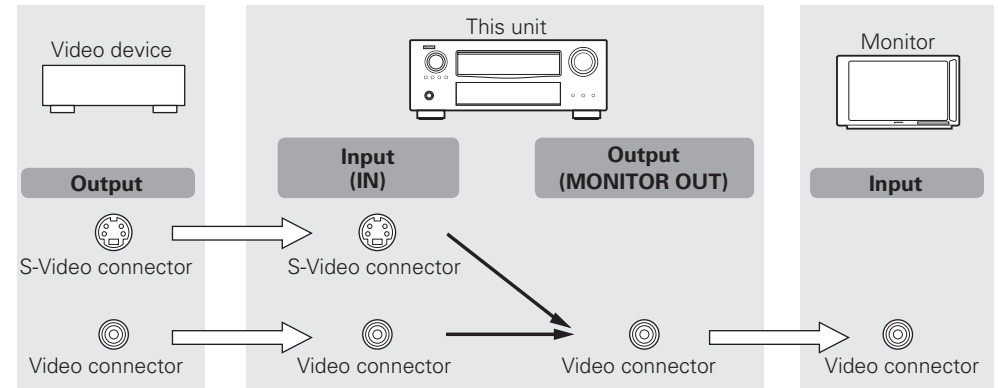

in Set as Necessary

- Set when not using the video conversion function.
- **"Video Convert"** (☞ page 66)
- Set when changing the resolution of the video signal.
- **"Resolution"** (☞ page 66)



- The video conversion function supports the NTSC, PAL, SECAM, NTSC 4.43, PAL-N, PAL-M and PAL-60 formats.
- The resolution of the video signal input to this unit's HDMI connector is the one set at "Resolution" (☞ page 66). (1080p HDMI signals and 1080p component signals are output at 1080p, regardless of the setting.)
- Resolutions of HDMI-compatible TVs can be checked at "HDMI Monitor 1 Information" or "HDMI Monitor 2 Information" (☞ page 86).

NOTE

- HDMI signals cannot be converted into analog signals.
- When a non-standard video signal from a game machine or some other source is input, the video conversion function might not operate.
- Component video input signals cannot be converted into Video format.
- A menu is output via the HDMI connector or component video connector.

Important information

Examples of screen display

- Menu screen

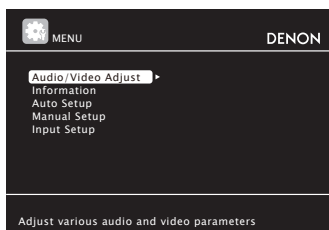

- Status display screen
When the input source is switched



- When the volume is adjusted

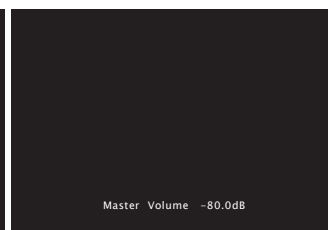

Status display: The operating status appears briefly on the screen when the input source is switched or the volume is changed.

NOTE

- If you operate the menu while playing back 3D video content, the playback video is replaced by the menu screen. The playback video is not displayed behind the menu screen.
- This unit does not show the status display while playing back 3D video content.

Connecting an HDMI-compatible device

You can connect up to six HDMI-compatible devices to the unit.

HDMI function

This unit supports the following HDMI functions:

- 3D
- Deep Color (🔧 page 106)
- Auto Lip Sync (🔧 page 77, 106)
- x.v.Color, sYCC601 color, Adobe RGB color, Adobe YCC601 color (🔧 page 106, 107)
- High definition digital audio format
- ARC (Audio Return Channel)
- Content Type
- CEC (HDMI control)

Copyright protection system

In order to play back digital video and audio such as BD-Video or DVD-Video via HDMI connection, both this unit and TV or the player need to support the copyright protection system known as HDCP (High-bandwidth Digital Content Protection System). HDCP is copyright protection technology comprised of data encryption and authentication of the connected AV device. This unit supports HDCP.

- If a device that does not support HDCP is connected, video and audio are not output correctly. Read the owner's manual of your television or player for more information.

About HDMI cables

- When a device supporting Deep Color signal transfer is connected, use a cable compatible "High Speed HDMI cable" or "High Speed HDMI cable with Ethernet".
- When the ARC function is used, connect a device with a "Standard HDMI cable with Ethernet" or "High Speed HDMI cable with Ethernet" for HDMI 1.4a.

HDMI control function (🔧 page 50)

This function allows you to operate external devices from the receiver and operate the receiver from external devices.

NOTE

- The HDMI control function may not work depending on the device it is connected to and its settings.
- You cannot operate a TV or Blu-ray Disc player/DVD player that is not compatible with the HDMI control function.

About 3D function

This unit supports input and output of 3D (3 dimensional) video signals of the HDMI 1.4a standards. For playing the 3D video content, a player, and a TV that support the 3D function of the HDMI 1.4a standards are required in addition to this unit.

NOTE

- If you operate the menu while playing back 3D video content, the playback video is replaced by the menu screen. The playback video is not displayed behind the menu screen.
- This unit does not show the status display while playing back 3D video content.

About ARC (Audio Return Channel) function

The Audio Return Channel in HDMI 1.4a enables a TV, via a single HDMI cable, to send audio data "upstream" to this unit.

NOTE

- To enable the ARC function, set "HDMI Control" to "ON" (🔧 page 78).
- ARC function is only supported for the HDMI MONITOR OUT 1 connector. In order to use the ARC function, connect the television to the HDMI MONITOR OUT 1 connector.
- When connecting a TV that does not support the ARC function, a separate connection using an audio cable is required. In this case, refer to "Connecting a TV" (🔧 page 16) for the connection method.

About Content Type

The HDMI specification version 1.4a enables simple, automated picture setting selection with no user intervention.

NOTE

To enable the Content Type, set "Video Mode" to "Auto" (🔧 page 66).

Cables used for connections

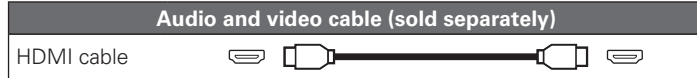

- This interface allows transfer of digital video signals and digital audio signals over a single HDMI cable.

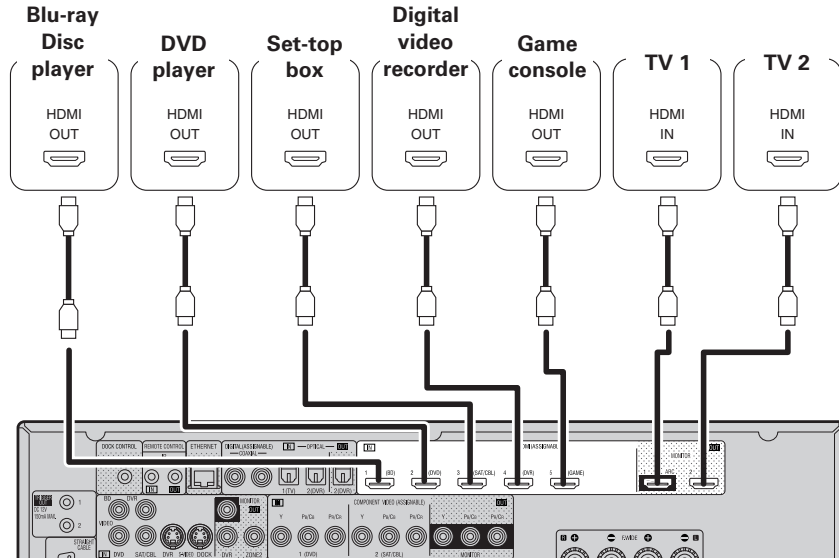

[Rear panel]

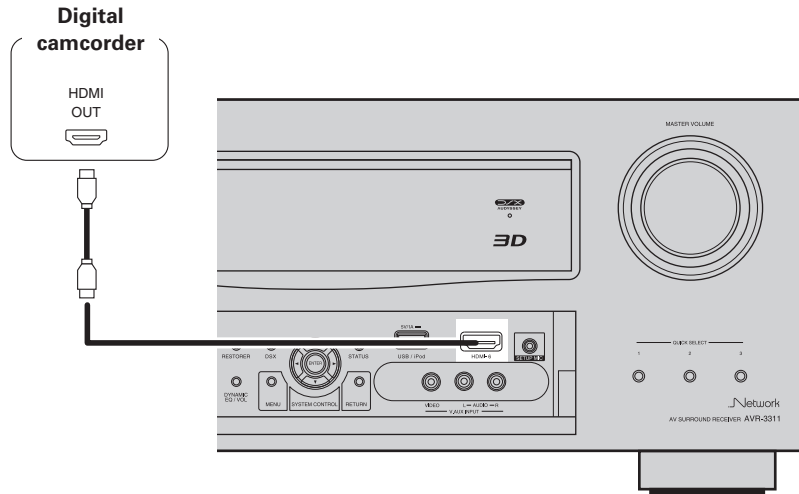

[Front panel]



- When this unit is connected to other devices with HDMI cables, connect this unit and TV also with an HDMI cable.
- When connecting a device that supports Deep Color transmission, please use a “High Speed HDMI cable” or “High Speed HDMI cable with Ethernet”.
- Video signals are not output if the input video signals do not match the monitor’s resolution. In this case, switch the Blu-ray Disc/DVD player’s resolution to a resolution with which the monitor is compatible.
- When this unit and monitor are connected with an HDMI cable, if the monitor is not compatible with HDMI audio signal playback, only the video signals are output to the monitor.

NOTE

- The HDMI signal is not simultaneously output to HDMI MONITOR 1 and HDMI MONITOR 2. Select the connector that you want to use in advance using “Monitor Out” (page 77) in the menu, or by pressing the **MONITOR SELECT** button on the remote control.
- HDMI control function is only supported for the HDMI MONITOR OUT 1 connector. In order to use the HDMI control function, connect the television to the HDMI MONITOR OUT 1 connector.
- The audio signal from the HDMI output connector (sampling frequency, number of channels, etc.) may be limited by the HDMI audio specifications of the connected device regarding permissible inputs.



Connecting to a device equipped with a DVI-D connector

When an HDMI/DVI conversion cable (sold separately) is used, the HDMI video signals are converted to DVI signals, allowing connection to a device equipped with a DVI-D connector.

NOTE

- No sound is output when connected to a device equipped with a DVI-D connector. Make separate audio connections.
- Signals cannot be output to DVI-D devices that do not support HDCP.
- Depending on the combination of devices, the video signals may not be output.

Settings related to HDMI connections

Set as necessary. For details, see the respective reference pages.

Input Assign (page 64)

Set this to change the HDMI input connector to which the input source is assigned.

HDMI Setup (page 77)

Make settings for HDMI video/audio output.

- RGB Range
- Auto Lip Sync
- HDMI Audio Out
- Monitor Out
- HDMI Control
- Standby Source
- Power Off Control

NOTE

The audio signals output from the HDMI connectors are only the HDMI input signals.

Connecting a TV

- Select the connector to use and connect the device.
- For video connections, see “Converting input video signals for output (Video conversion function)” (page 13).
- For instructions on HDMI connections, see “Connecting an HDMI-compatible device” (page 14).



To listen to TV audio through this device, use the optical digital connection.

NOTE

This connection is not required when a TV compatible with the ARC function (Audio Return Channel (HDMI 1.4a standard function) is connected to this unit via an HDMI connection.

For details, see “About ARC (Audio Return Channel) function” (page 14) or refer to the instruction manual for your TV.

Cables used for connections

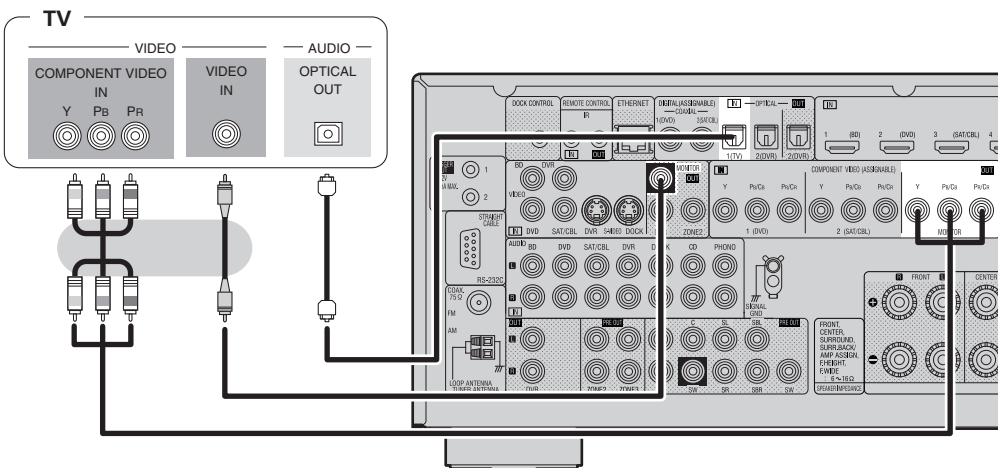
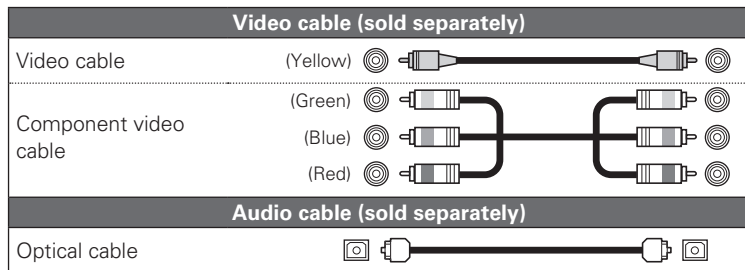

in Set as Necessary

Set this to change the digital input connector or component video input connector to which the input source is assigned.

“Input Assign” (page 64)

Connecting a Blu-ray Disc player

- You can enjoy video and audio from a Blu-ray Disc.
- Select the connector to use and connect the device.
- For instructions on HDMI connections, see “Connecting an HDMI-compatible device” (page 14).

Cables used for connections

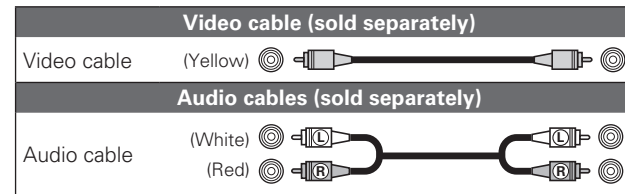

Blu-ray Disc player

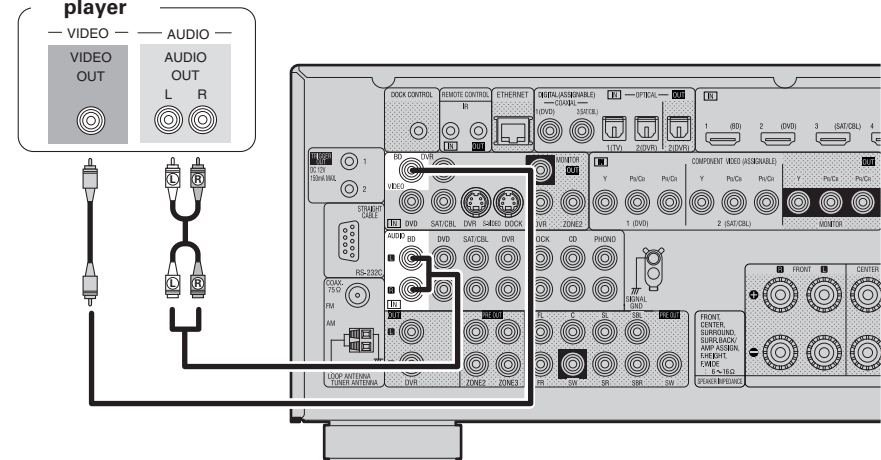

in Set as Necessary

Set this to change the digital input connector or component video input connector to which the input source is assigned.

“Input Assign” (page 64)



For HD audio (Dolby TrueHD, DTS-HD, Dolby Digital Plus and DTS Express) playback, connect with HDMI (page 14 “Connecting an HDMI-compatible device”).

Connecting a DVD player

- You can enjoy video and audio from a DVD.
- Select the connector to use and connect the device.
- For instructions on HDMI connections, see “Connecting an HDMI-compatible device” (📖 page 14).

Cables used for connections

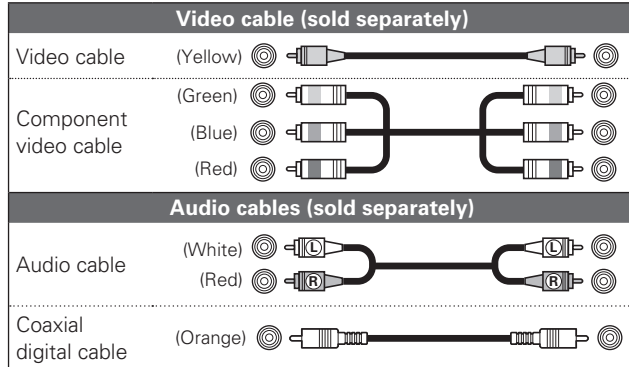

Connecting a set-top box (Satellite tuner/cable TV)

- You can watch satellite or cable TV.
- Select the connector to use and connect the device.
- For instructions on HDMI connections, see “Connecting an HDMI-compatible device” (📖 page 14).

Cables used for connections

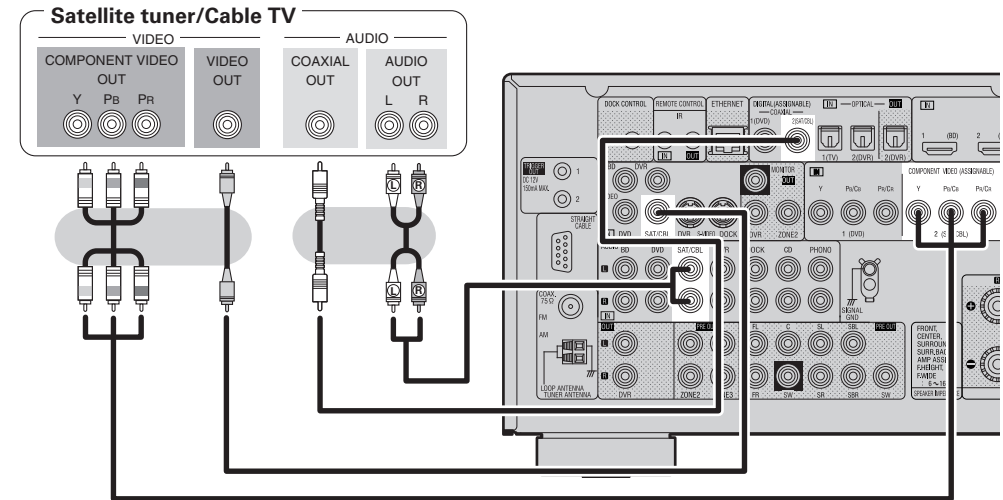
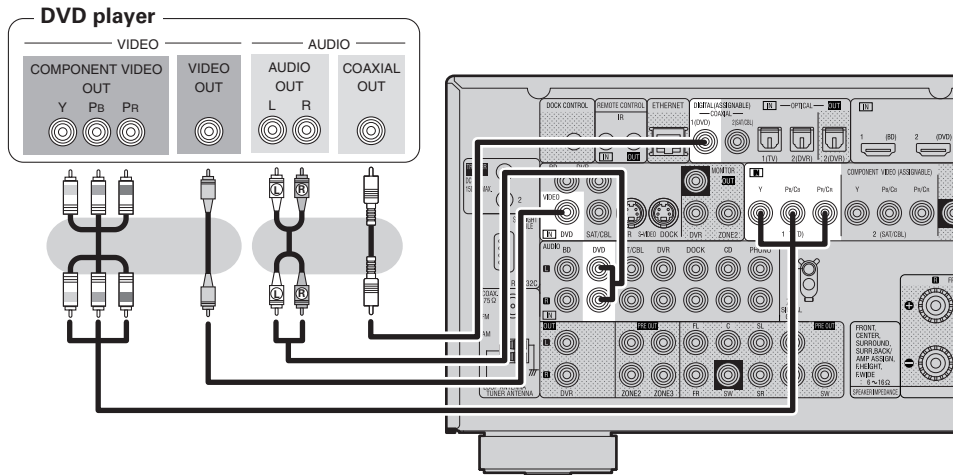
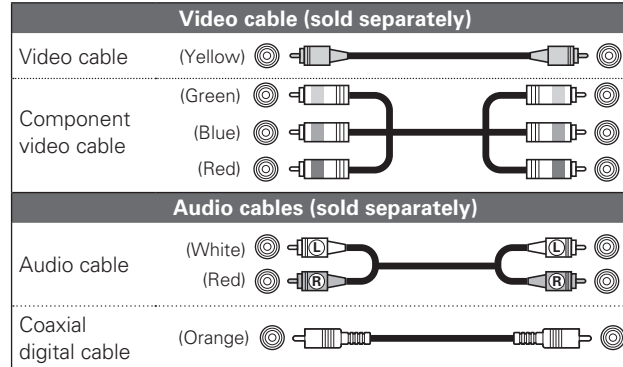

in Set as Necessary

Set this to change the digital input connector or component video input connector to which the input source is assigned.

“Input Assign” (📖 page 64)

in Set as Necessary

Set this to change the digital input connector or component video input connector to which the input source is assigned.

“Input Assign” (📖 page 64)

Connecting a digital video recorder

- You can record video onto a Blu-ray Disc or DVD.
- Select the connector to use and connect the device.
- When recording analog audio, use the analog connection.
- See "REC OUT mode" (page 52) for operating instructions.
- For instructions on HDMI connections, see "Connecting an HDMI-compatible device" (page 14).

Cables used for connections

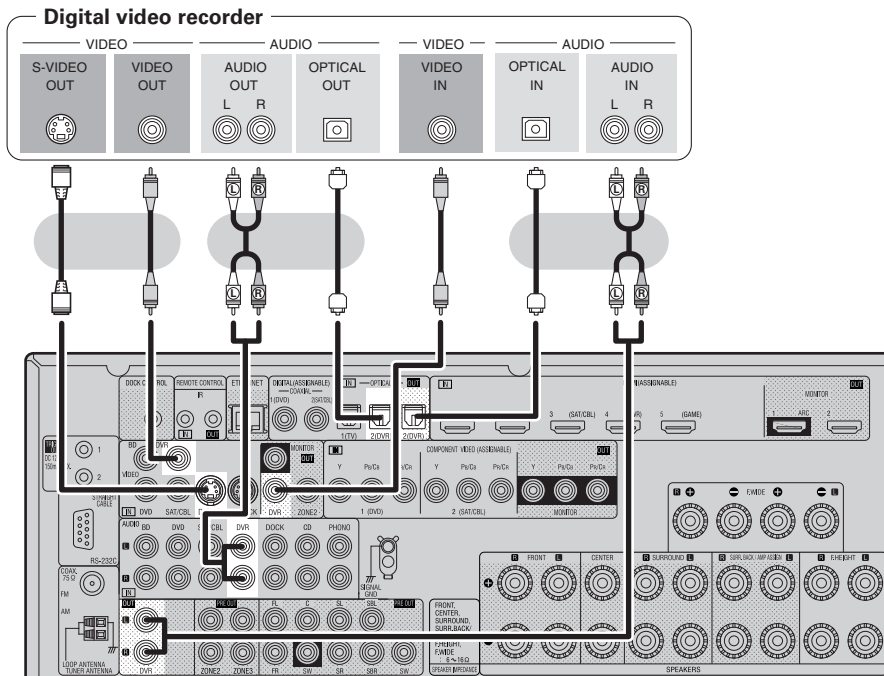
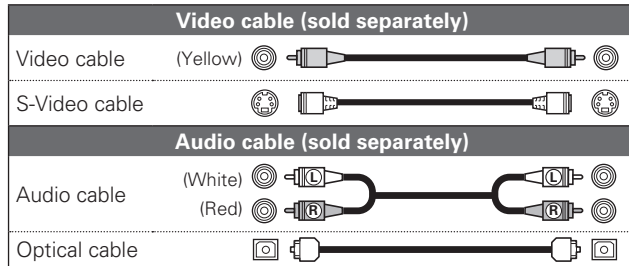

in Set as Necessary

Set this to change the digital input connector or component video input connector to which the input source is assigned.
"Input Assign" (page 64)

NOTE

To record video signals through this unit, use the same type of video cable for connection between this unit and the player as used for connection between this unit and the recorder.

Connecting a digital camcorder

- You can enjoy video and audio from a digital camcorder.
- You can enjoy games by connecting a game machine via the V.AUX input connector. In this case, select the input source to "V.AUX".
- For instructions on HDMI connections, see "Connecting an HDMI-compatible device" (page 14).

Cables used for connections

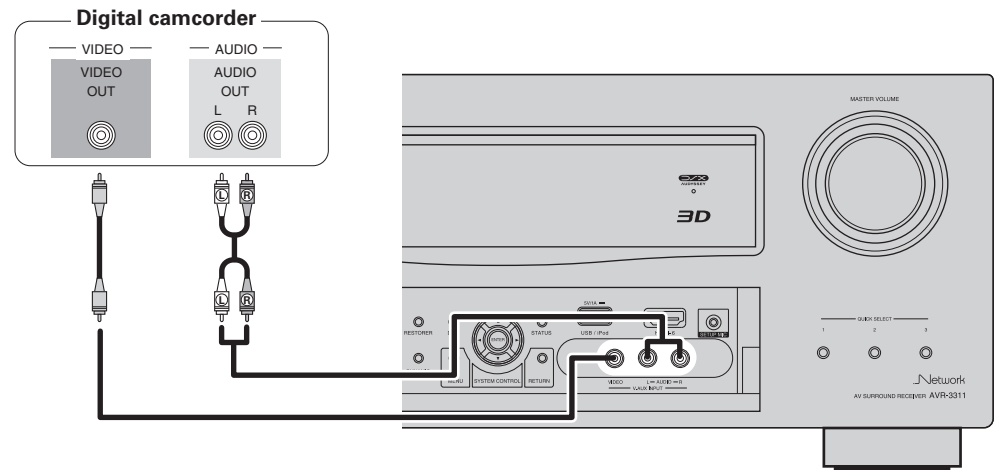
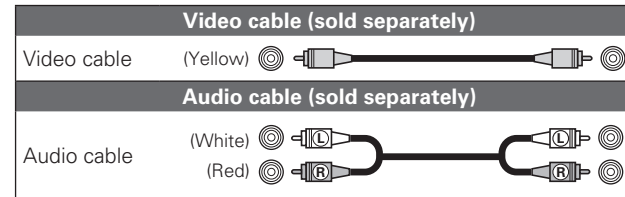

in Set as Necessary

Set this to change the digital input connector or component video input connector to which the input source is assigned.
"Input Assign" (page 64)

NOTE

When a non-standard video signal from a game machine or some other source is input, the video conversion function might not operate. In this case, use the monitor output of the same connector as the input.

Connecting a control dock for iPod

- Connect a control dock for iPod to the unit to enjoy video and music stored on an iPod.
- For a control dock for iPod, use ASD-1R and ASD-11R made by DENON (sold separately).
- For instructions on the control dock for iPod settings, refer to the control dock for iPod's operating instructions.

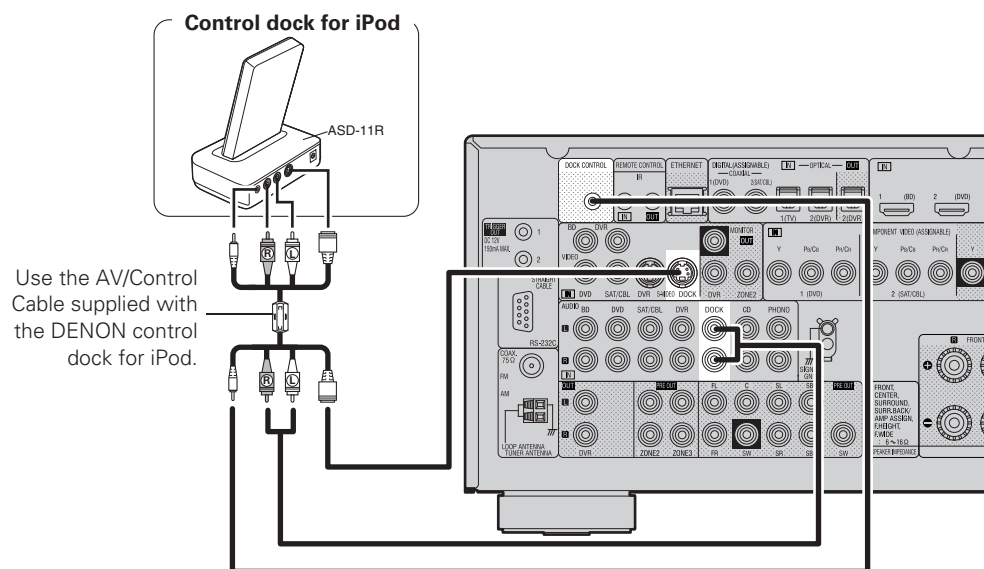

You can also connect the iPod you are using directly to the USB port of this unit (see page 19 "Connecting an iPod or USB memory device to the USB port").

NOTE

When connecting an iPhone to this unit, keep the iPhone at least 20 cm away from this unit. If the iPhone is kept closer to this unit and a telephone call is received by the iPhone, noise may be output from this device.

Connecting an iPod or USB memory device to the USB port

You can enjoy music stored on an iPod or USB memory device.

Cables used for connections

To connect an iPod to this unit, use the USB cable supplied with the iPod.

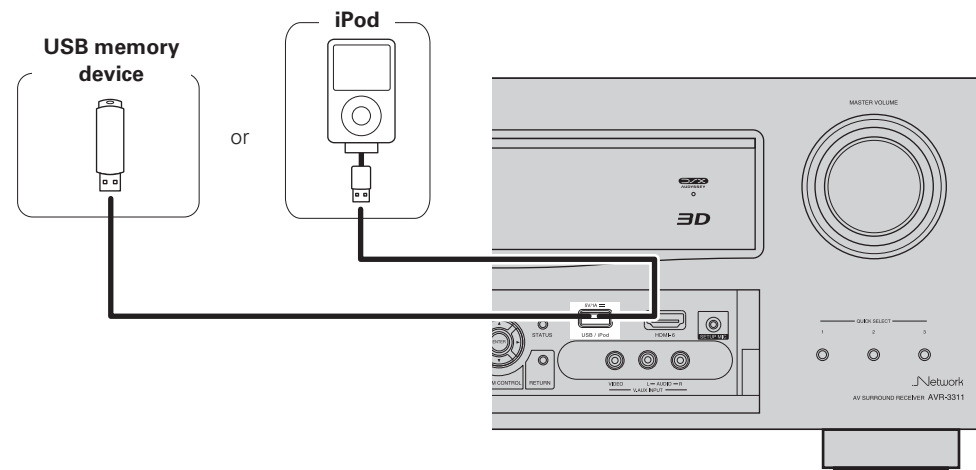

- When you want to playback a video file stored on an iPod, use a DENON control dock for iPod (ASD-1R and ASD-11R, sold separately) (see page 19 "Connecting a control dock for iPod").
- With iPods, playback is possible with iPhone, iPod touch, classic and nano released from the 5th-generation of iPods. For details, check the DENON web site or page 27.
- DENON does not guarantee that all USB memory devices will operate or receive power. When using a portable USB connection type HDD of the kind to which an AC adapter can be connected to supply power, use the AC adapter.

NOTE

- USB memory devices will not work via a USB hub.
- Do not use an extension cable when connecting a USB memory device. This may cause radio interference with other devices.

Connecting an antenna

- Connect the FM antenna or AM loop antenna supplied with the unit to enjoy listening to radio broadcasts.
- After connecting the antenna and receiving a broadcast signal (see page 28 “Listening to FM/AM broadcasts”), fix the antenna with tape in a position where the noise level becomes minimal.

AM loop antenna (supplied)

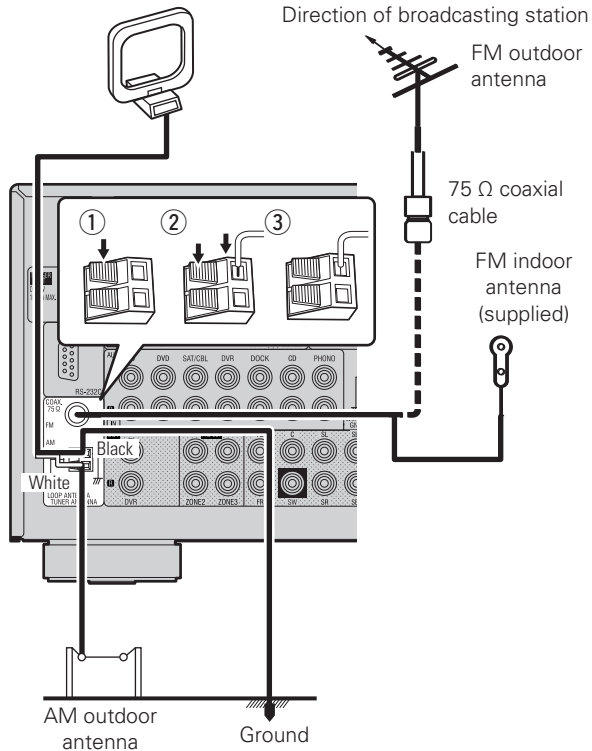

AM loop antenna assembly

- 1 Put the stand section through the bottom of the loop antenna from the rear and bend it forward.
- 2 Insert the projecting part into the square hole in the stand.

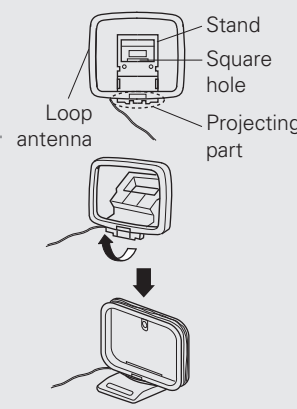

Using the AM loop antenna

Suspending on a wall

Suspend directly on a wall without assembling.



Standing alone

Use the procedure shown left to assemble.

NOTE

- Do not connect two FM antennas simultaneously.
- Even if an external AM antenna is used, do not disconnect the AM loop antenna.
- Make sure the AM loop antenna lead terminals do not touch metal parts of the panel.
- If the signal has noise interference, connect the ground terminal (GND) to reduce noise.
- If you are unable to receive a good broadcast signal, we recommend installing an outdoor antenna. For details, inquire at the retail store where you purchased the unit.

Connecting a record player

You can enjoy playing records.

Cables used for connections

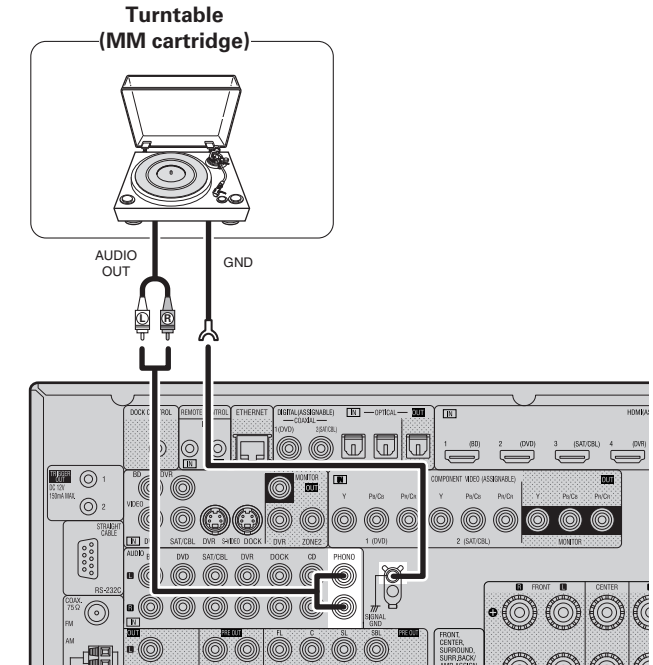
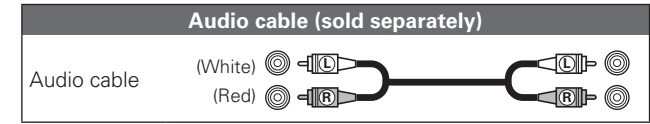

- This unit is compatible with record players with an MM cartridge. When you connect to a record player with an MC cartridge, use a commercially available MC head amp or a step-up transformer.
- When you increase the volume without connecting the record player, there may be “booming” noise from the speakers.

NOTE

The SIGNAL GND terminal of this unit is not a safety ground connection. Connect it to reduce noise when noise is excessive. Note that depending on the record player, connecting the ground line may have the reverse effect of increasing noise. In this case, it is not necessary to connect the ground line.

Connecting a CD player

- You can enjoy CD sound.
- Select the connector to use and connect the device.

Cables used for connections

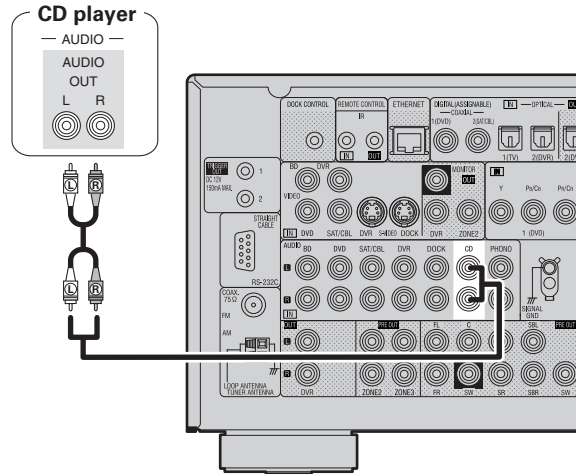
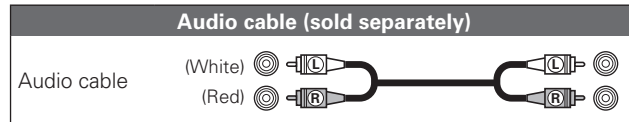

in Set as Necessary

Set this to change the digital input connector to which the input source is assigned.
"Input Assign" (page 64)

Connecting an external power amplifier

- You can use this unit as a pre-amp by connecting a commercially available power amp to the PRE OUT connector. Adding a power amp to each of the channels provides an even greater sound presence.
- Select the terminal to use and connect the device.

Cables used for connections

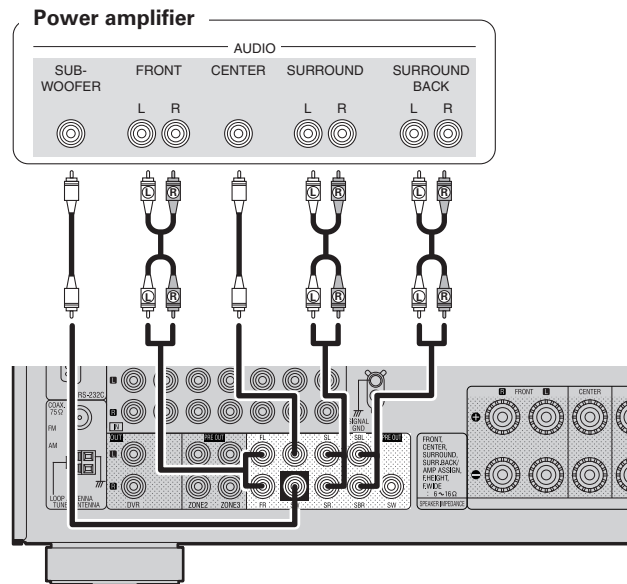
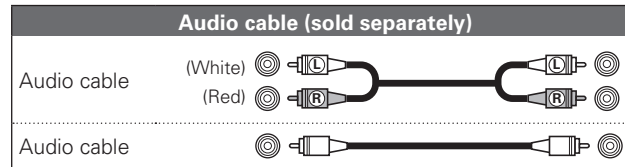

- When using just one surround back speaker, connect it to the left channel (L) terminal.
- Use the volume control on the subwoofer to control subwoofer volume.
- If the subwoofer volume sounds low, use the volume control provided on the subwoofer to adjust the volume.

NOTE

- When speakers have been connected to PRE OUT terminals, do not connect the speakers to the speaker terminals.
- The output channels for the PRE OUT connector change to SBL and SBR in the "Amp Assign" (page 75) settings in the menu.

Connecting to a home network (LAN)

- This unit lets you play via your home network (LAN) music files stored on a computer and music content such as that from Internet radio.
You can also operate this unit from a computer using the Web control function.
- You can update by downloading the latest firmware from the DENON website.
For more information, on the menu, select "Firmware Update" (☞ page 84).
- See "Network Setup" on the menu (☞ page 79) for more information on network setting.

Cables used for connections

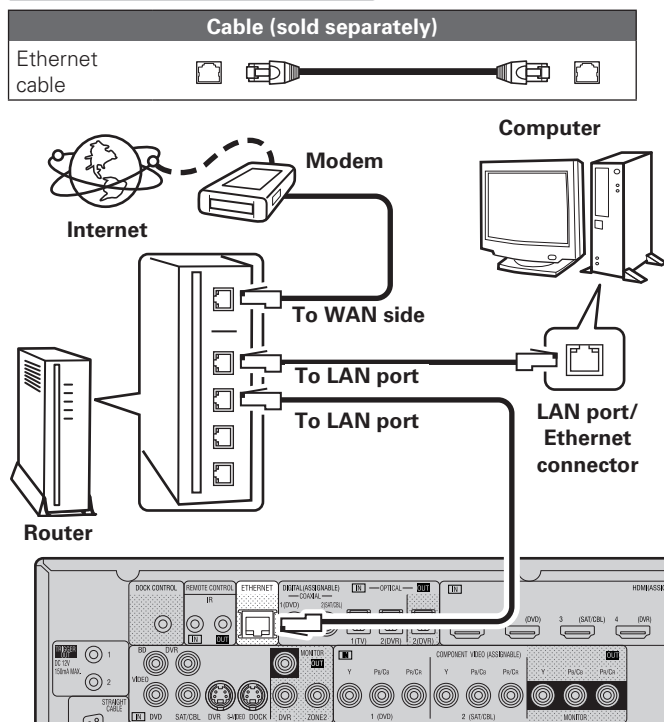

For connections to the Internet, contact an ISP (Internet Service Provider) or a computer shop.

Required system

❑ Broadband internet connection

❑ Modem

Device that connects to the broadband circuit and conducts communications on the Internet.

A type that is integrated with a router is also available.

❑ Router

When using this unit, we recommend you use a router equipped with the following functions:

- Built-in DHCP server
This function automatically assigns IP addresses on the LAN.
- Built-in 100BASE-TX switch

When connecting multiple devices, we recommend a switching hub with a speed of 100 Mbps or greater.

❑ Ethernet cable (CAT-5 or greater recommended)

- Use only shielded STP or ScTP LAN cable which is available at retailer.
- Some flat type Ethernet cables are easily affected by noise.
We recommend using a normal type cable.



- If you have an Internet provider contract for a line on which network settings are made manually, make the settings at "Network Setup" (☞ page 79).
- With this unit, it is possible to use the DHCP and Auto IP functions to make the network settings automatically.
- When using this unit with the broadband router's DHCP function enabled, this unit automatically performs the IP address setting and other settings.
When using this unit connected to a network with no DHCP function, make the settings for the IP address, etc., at "Network Setup" (☞ page 79).
- When setting manually, check the setting contents with the network administrator.

NOTE

- A contract with an ISP is required to connect to the Internet.
No additional contract is needed if you already have a broadband connection to the Internet.
- The types of routers that can be used depend on the ISP. Contact an ISP or a computer shop for details.
- DENON assumes no responsibility whatsoever for any communication errors or troubles resulting from customer's network environment or connected devices.
- This unit is not compatible with PPPoE. A PPPoE-compatible router is required if you have a contract for a type of line set by PPPoE.
- Do not connect an ETHERNET connector directly to the LAN port/Ethernet connector on your computer.

Connecting an external control device

REMOTE CONTROL jacks

If this unit is installed in a location that is out of range of the signal from the remote control unit, you can still operate the unit and the devices connected to it by using a commercially available IR receiver. You can also use it to remotely control ZONE2, ZONE3 (another room).

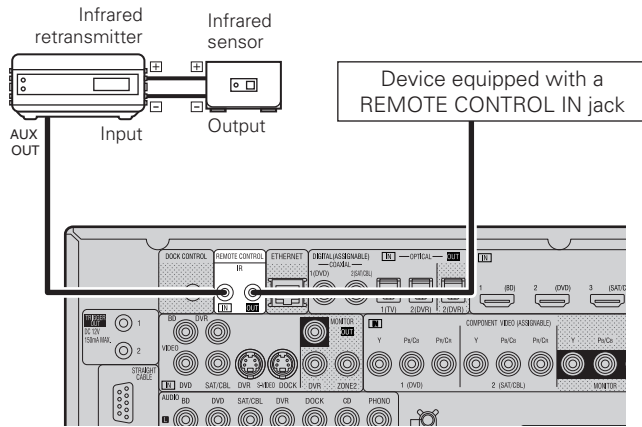

RS-232C connector

When you connect an external control device, you can control this unit with the external control device.

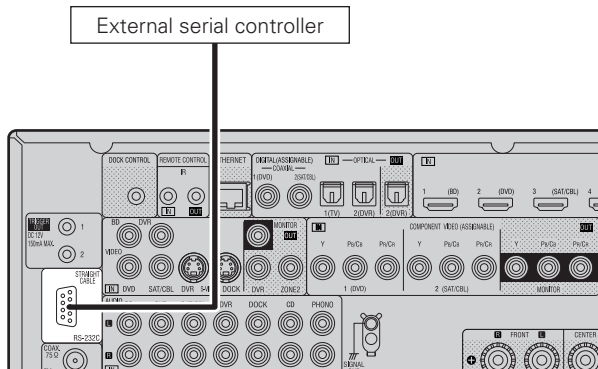

Perform the operation below beforehand.

- ① Turn on the power of this unit.
- ② Turn off the power of this unit from the external controller.
- ③ Check that the unit is in the standby mode.

TRIGGER OUT jacks

When a device with TRIGGER IN jack is connected, the connected device's power on/standby can be controlled through linked operation to this unit.

The TRIGGER OUT jack outputs a maximum 12 V/150 mA electrical signal.

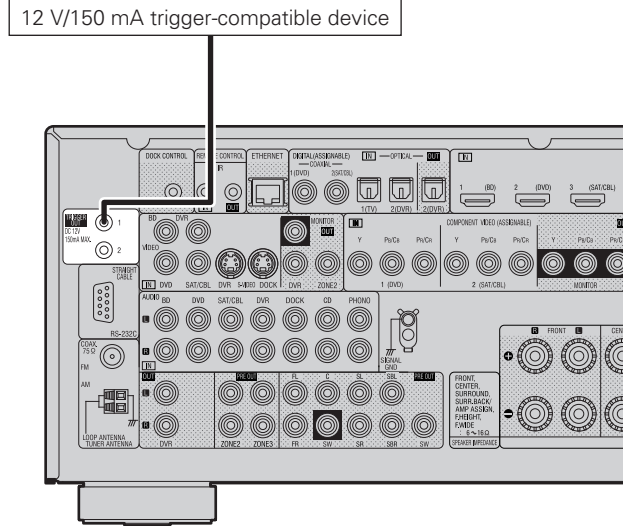

in Set as Necessary

Set to change the conditions for linked operation via the TRIGGER OUT 1 or 2 jack.

"Trigger Out 1" or **"Trigger Out 2"** (page 83)

NOTE

If the permissible trigger input level for the connected device is larger than 12V/150mA, or has shorted, the TRIGGER OUT jack cannot be used.

In this case, turn off the power to the unit, and disconnect it.

Playback (Basic operation)

- ❑ **Selecting the input source** (👉 page 24)
- ❑ **Adjusting the master volume** (👉 page 24)
- ❑ **Turning off the sound temporarily** (👉 page 25)

❑ **Playing a Blu-ray Disc player/DVD player** (👉 page 25)

- ❑ **Playing a CD player** (👉 page 25)
- ❑ **Playing an iPod®** (👉 page 25)
- ❑ **Tuning in radio stations** (👉 page 28)
- ❑ **Playing a network audio** (👉 page 30)
- ❑ **Playing a USB memory device** (👉 page 38)

Selecting a listening mode (Surround mode)

(👉 page 40)

Playback (Advanced operation) (👉 page 50)

Important information

Before starting playback, make the connections between the different components and the settings on the receiver.

NOTE

Also refer to the operating instructions of the connected components when playing them.

Selecting the input source

Press the input source select button (**NET/USB, iPod, DVD, BD, TUNER, DOCK, SAT/CBL, GAME, V.AUX, PHONO, CD, DVR, TV**) to be played back.

The desired input source can be selected directly.

- When **iPod PLAY** is pressed, the input source of this unit is switched to “DOCK” or “NET/USB” and the connected iPod is automatically played (👉 page 28 “iPod play function”).



You can also use the following operation to select an input source.

❑ Using the “Source Select” menu

- ① Press **SOURCE SELECT**.
Display the “Source Select” menu.

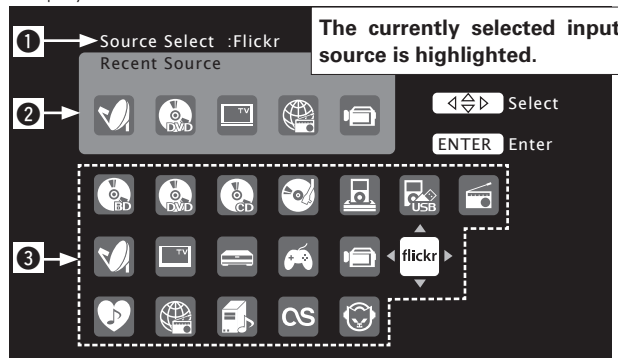

- ① **Input Source**
The name of the highlighted input source is displayed.
- ② **Recently used sources**
The recently used input sources (up to five) are displayed.
- ③ **Icons for the input sources in the different categories are displayed.**

- ② Use **Δ ∇ ◀ ▶** to select the input source, then press **ENTER**.

The input source is set and the source selection menu is turned off.

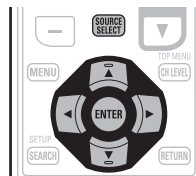

- When using with an iPod connected directly to the USB port of this unit, select “**USB** (USB/iPod)” for the input source.
- Input sources that are not going to be used can be set ahead of time. Make this setting at “Source Delete” (👉 page 82).
- To turn off the source selection menu without selecting an input source, press **SOURCE SELECT** again.

❑ Using the knob on the main unit

Turn **SOURCE SELECT**.

- If “Rec Select” or “Tuning Preset” mode is selected for the input source, press **SOURCE** before turning **SOURCE SELECT**.
- Turning **SOURCE SELECT** switches the input source, as shown below.

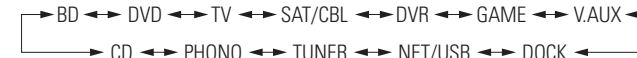
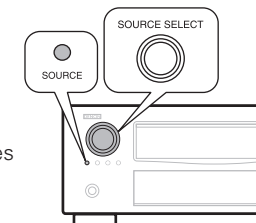

Adjusting the master volume

Use **VOL ▲ ▼** to adjust the volume.

- ❑ When the “Volume Display” setting (👉 page 82) is “Relative”
[Adjustable range]
--- -80.5dB - 18.0dB

- ❑ When the “Volume Display” setting (👉 page 82) is “Absolute”
[Adjustable range] 0.0 - 99.0

- The variable range differs according to the input signal and channel level setting.

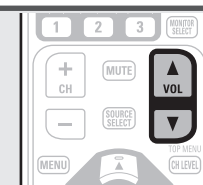

You can also operate via the main unit. In this case, perform the following operations.

Turn **MASTER VOLUME** to adjust the volume.

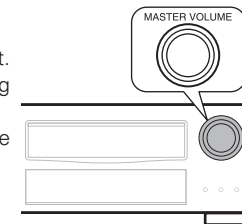

Important information

Turning off the sound temporarily

Press **MUTE**.

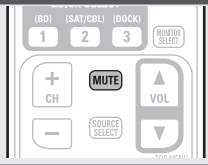

- The sound is reduced to the level set at “Mute Level” (page 82).
- To cancel, press **MUTE** again. Muting can also be canceled by adjusting the master volume.

Playing a Blu-ray Disc player/DVD player

The following describes the procedure for playing Blu-ray Disc player/DVD player.

1 Prepare for playback.

- ① Turn on the power of the TV, subwoofer and player.
- ② Change the TV input to the input of this unit.
- ③ Load the disc in the player.



2 Press **POWER ON** to turn on power to the unit.

3 Press **BD** or **DVD** to switch an input source for a player used for playback.

4 Play the component connected to this unit.

Make the necessary settings on the player (language setting, subtitles setting, etc.) beforehand.

Playing a CD player

The following describes the procedure for playing CD player.

1 Prepare for playback.

- ① Turn on the power of the subwoofer and player.
- ② Load the disc in the player.

2 Press **POWER ON** to turn on power to the unit.

3 Press **CD** to switch the input source to the CD player.

4 Play the component connected to this unit.



Playing an iPod®

There are two methods for iPod playback.

- ① **Use a DENON control dock for iPod to play back.**
You can play back both video, photo and audio.
- ② **Connect an iPod directly to the USB port to play back** (page 27).
You can play back audio only.

① Use a DENON control dock for iPod to play back

DENON control dock for iPod usable on this unit
• ASD-1R / ASD-11R

Listening to music on an iPod®

1 Prepare for playback.

- ① Connect the DENON control dock for iPod to this unit (page 19 “Connecting a control dock for iPod”).
- ② Set the iPod® in the DENON control dock for iPod.



2 Press **POWER ON** to turn on power to the unit.

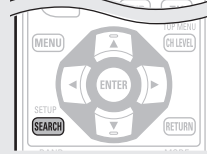

3 Press **DOCK** to switch the input source to “DOCK”.

- If “Browse mode” is selected in step 4, the following screen is displayed on a TV screen, depending on the connected control dock for iPod.

(When using an ASD-1R)

(When using an ASD-11R)

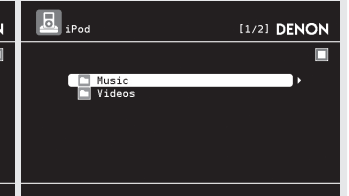
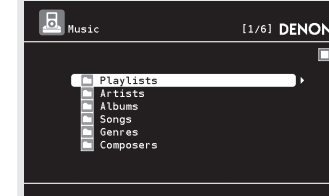

- In “Browse mode”, the iPod display is as shown at right.

NOTE

If the connections screen is not displayed, the iPod may not be properly connected. Reconnect it.

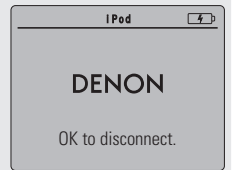

4 Press **SEARCH** and hold it down for 2 seconds or more to select the display mode.

- There are two modes for displaying the contents recorded on the iPod.

- Browse mode** Display iPod information on the TV screen.
 - English letters, numbers and certain symbols are displayed. Incompatible characters are displayed as “.” (period).
- Remote mode** Display iPod information on the iPod screen.
 - “Remote iPod” is displayed on the display of this unit.

		Display mode	Browse mode	Remote mode
Playable files	Music file		✓	✓
	Photo file			✓ *2
	Video file		✓ *1	✓ *2
Active buttons	Remote control unit (This unit)		✓	✓
	iPod®			✓

*1 When using an ASD-11R DENON control dock for iPod.
*2 Video may not be output, depending on the combination of ASD-1R or ASD-11R DENON control dock for iPod and iPod.

Simple version

Basic version

Advanced version

Information

Playing an iPod®

5 Use Δ ∇ to select the item, then press **ENTER** or \triangleright to select the file to be played.

6 Press **ENTER**, \triangleright or \blacktriangleright . Playback starts.

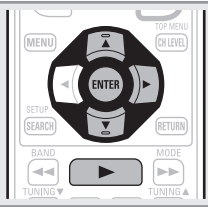

- You can specify the duration of the on-screen display to be displayed (default: 30 sec) at menu "iPod" (page 83). Press Δ ∇ \triangleleft \triangleright to return to the original screen.
- To play back compressed audio with extended bass or treble reproduction, we recommend playback in RESTORER mode (page 73). The default setting is "Mode3".
- In Browse mode, press **STATUS** during playback to check the title name, artist name, and album name.

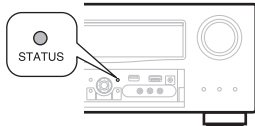

NOTE

- Press **POWER OFF** and set this unit's power to the standby mode before disconnecting the iPod. Also switch the input source to "DOCK" before disconnecting the iPod.
- Depending on the type of iPod and the software version, some functions may not operate.
- Note that DENON will accept no responsibility whatsoever for any problems arising with the data on an iPod when using this unit in conjunction with the iPod.

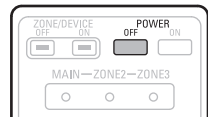

Viewing videos on an iPod® in the Browse mode

When an iPod equipped with a video function is connected to a DENON ASD-11R control dock for iPod, image files can be played in the Browse mode.

1 Use Δ ∇ to select "Videos", then press **ENTER** or \triangleright .

2 Use Δ ∇ to select the search item or folder, then press **ENTER** or \triangleright .

3 Use Δ ∇ to select the video file, then press **ENTER**, \triangleright or \blacktriangleright . Playback starts.

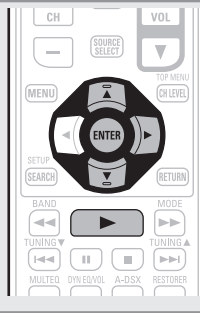

Viewing photos and videos on an iPod® in the Remote mode

This unit can play back on a TV screen photos and data stored on an iPod equipped with a slide show or video function.

1 Press and hold **SEARCH** to set the Remote mode.
"Remote iPod" or "Dock Remote" is displayed on the display of this unit.

2 Watching the iPod's screen, use Δ ∇ to select "Photos" or "Videos".

- Depending on the iPod model, it may be necessary to operate the iPod unit directly.

3 Press **ENTER** until the image you want to view is displayed.

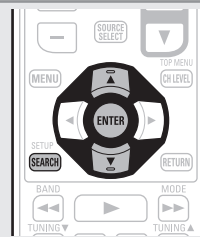

"TV Out" at the iPod's "Slide show Settings" or "Video Settings" must be set to "On" in order to display the iPod's photo data or videos on the monitor. For details, see the iPod's operating instructions.

NOTE

Video may not be output, depending on the combination of ASD-11R or ASD-11R and iPod.

iPod operation



Operation buttons	Function
MENU	Amp menu
Δ ∇ \triangleleft \triangleright	Cursor operation / Auto search (cue, Δ ∇) / Manual search (Press and hold, Δ ∇)
ENTER (Press and release)	Enter / Pause
ENTER (Press and hold)	Stop
SEARCH (Press and release)	Page search mode *
SEARCH (Press and hold)	Browse / Remote mode switching
RETURN	Return
$\triangleleft\triangleleft\triangleleft$ $\triangleright\triangleright\triangleright$ (Press and hold)	Manual search (fast-reverse/fast-forward)
\blacktriangleright	Playback / Pause
$\blacktriangleleft\triangleright\blacktriangleright$	Auto search (cue)
II	Pause
■	Stop
RESTORER	RESTORER
TV POWER	TV power on/standby (Default : SONY)
TV INPUT	Switch TV input (Default : SONY)

- Repeat playback (page 67 "Repeat")
- Shuffling playback (page 67 "Shuffle")

* When the menu screen is displayed, press **SEARCH**, then press \triangleleft (previous page) or \triangleright (next page). To cancel, press Δ ∇ or **SEARCH**.

2 Connect an iPod directly to the USB port to play back

You can use the USB cable provided with the iPod® to connect the iPod with the unit's USB port and enjoy music stored on the iPod.

- This unit supports audio playback from the iPod (fifth generation or later), iPod nano, iPod classic, iPod touch and iPhone (it is not compatible with iPod shuffle).

1 Connect the iPod® to the USB port (page 19 "Connecting an iPod or USB memory device to the USB port").

2 Press POWER ON to turn on power to the unit.

3 Press NET/USB to switch the input source to "NET/USB".

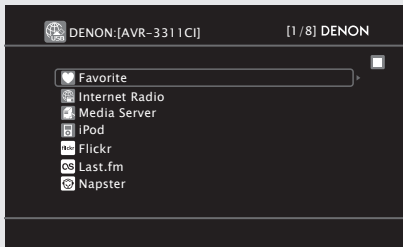

4 Use Δ∇ to select "iPod", then press ENTER or ▷.

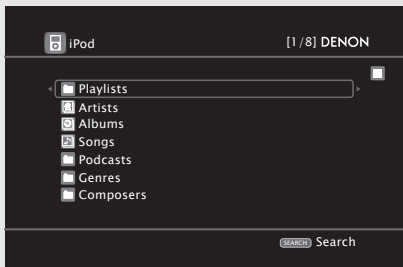

NOTE

If the connections screen is not displayed, the iPod may not be properly connected. Reconnect it.



5 Press SEARCH and hold it down for 2 seconds or more to select the display mode.

- There are two modes for displaying the contents recorded on the iPod.

Browse mode Display iPod information on the TV screen.

- English letters, numbers and certain symbols are displayed. Incompatible characters are displayed as "." (period).

Remote mode Display iPod information on the iPod screen.

- "Remote iPod" is displayed on the display of this unit.
- The Remote mode is not supported on fifth generation iPod or first generation iPod nano.

Display mode		Browse mode	Remote mode
Playable files	Music file	✓	✓
	Video file		*
Active buttons	Remote control unit (This unit)	✓	✓
	iPod®		✓

* Only the sound is played.

6 Use Δ∇ to select the item, then press ENTER or ▷ to select the file to be played.

7 Press ENTER, ▷ or ►. Playback starts.



- You can specify the duration of the on-screen display to be displayed (default: 30 sec) at menu "iPod" (page 83). Press Δ∇◀▷ to return to the original screen.
- To play back compressed audio with extended bass or treble reproduction, we recommend playback in RESTORER mode (page 73). The default setting is "Mode3".
- In Browse mode, press **STATUS** during playback to check the title name, artist name, and album name.

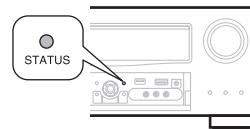

NOTE

- Depending on the type of iPod and the software version, some functions may not operate.
- Note that DENON will accept no responsibility whatsoever for any problems arising with the data on an iPod when using this unit in conjunction with the iPod.

□ iPod operation



Operation buttons	Function
MENU	Amp menu
Δ∇◀▷	Cursor operation / Auto search (cue, Δ∇) / Manual search (Press and hold, Δ∇)
ENTER (Press and release)	Enter / Pause
ENTER (Press and hold)	Stop
SEARCH (Press and release)	Page search *1 / Character search *2
SEARCH (Press and hold)	Browse / Remote mode switching
RETURN	Return
◀◀▶▶ (Press and hold)	Manual search (fast-reverse/fast-forward)
▶▶▶▶	Playback / Pause
◀◀▶▶▶▶	Auto search (cue)
⏸	Pause
■	Stop
RESTORER	RESTORER
TV POWER	TV power on/standby (Default : SONY)
TV INPUT	Switch TV input (Default : SONY)

- Repeat playback (page 68 "Repeat")
- Random playback (page 68 "Random")

*1 When the menu screen is displayed, press **SEARCH**, then press ◀ (previous page) or ▷ (next page).

To cancel, press Δ∇ or **SEARCH** twice.

*2 When the menu screen is displayed, press **SEARCH** twice, then press ◀▷ to select the first letter you want to search mode.

- If it is not possible to search the list, "unsorted list." is displayed.

To cancel, press Δ∇ or **SEARCH**.



If the list is not in alphabetical order, you may not be able to perform a character search.

Playing an iPod®

iPod play function

If **iPod PLAY** is pressed when power of this unit is on standby and a control dock for iPod or an iPod (USB) is connected, the iPod starts playback.

Press iPod PLAY.

- Power of this unit is turned on.
- This unit's input source switches to "DOCK" or "NET/USB".
- iPod playback starts.



If **iPod PLAY** on the main unit is pressed, the same function as with the remote control unit can be obtained.



NOTE

- iPod play function does not function if a control dock for iPod ("DOCK") or an iPod ("NET/USB") is not connected.
- If both a control dock for iPod ("DOCK") and an iPod ("NET/USB") are connected, playback with control dock for iPod ("DOCK") takes priority.

Tuning in radio stations

Listening to FM/AM broadcasts

1 Press **TUNER** to switch the input source to "TUNER".

2 Press **BAND** to select "FM" or "AM".

FM When listening to an FM broadcast.

AM When listening to an AM broadcast.

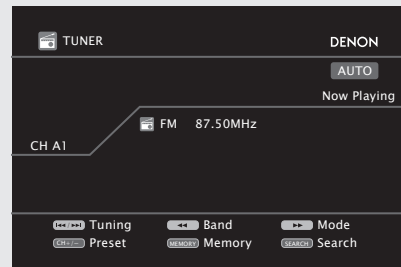
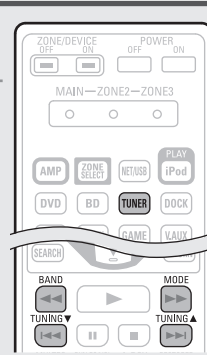

3 Tune in the desired broadcast station.

① To tune in automatically (Auto tuning)

Press **MODE** to light the "AUTO" indicator on the display, then use **TUNING ▲** or **TUNING ▼** to select the station you want to hear.

② To tune in manually (Manual tuning)

Press **MODE** to turn off the display's "AUTO" indicator, then use **TUNING ▲** or **TUNING ▼** to select the station you want to hear.



- If the desired station cannot be tuned in with auto tuning, tune it in manually.
- When tuning in stations manually, press and hold **TUNING ▲** or **TUNING ▼** to change frequencies continuously.
- You can specify the duration of the on-screen display to be displayed (default: 30 sec) at menu "TUNER" (page 83). Press **▲ ▼ ◀ ▶** to return to the original screen.

□ Presetting radio stations (Manual preset)

Your favorite broadcast stations can be preset so that you can tune them in easily. Up to 56 stations can be preset.

• Stations can be preset automatically at "Auto Preset" (page 64). If "Auto Preset" is performed after performing "Manual Preset", the "Manual Preset" settings will be overwritten.

1 Tune in the broadcast station you want to preset.

2 Press **MEMORY**.

3 Press **SHIFT** to select the block (A to G) in which to preset the channel (1 to 8 per block), then press **CH +**, **CH -** or **1 - 8** to select the preset number.

4 Press **MEMORY** again to complete the setting.

- To preset other stations, repeat steps 1 to 4.



Default settings

Block (A - G) and Channel (1 - 8)	Default Settings
A1 - A8	87.5 / 89.1 / 98.1 / 108.0 / 90.1 / 90.1 / 90.1 / 90.1 MHz
B1 - B8	522 / 603 / 999 / 1404 / 1611 kHz, 90.1 / 90.1 / 90.1 MHz
C1 - C8	90.1 MHz
D1 - D8	90.1 MHz
E1 - E8	90.1 MHz
F1 - F8	90.1 MHz
G1 - G8	90.1 MHz

Specify a name for the preset broadcast station (Preset Name) (page 64)

Listening to preset stations

- 1 Press **SHIFT** to select the memory block (A to G).
- 2 Press **CH +**, **CH -** or **1 - 8** to select the desired preset channel.



You can also operate via the main unit. In this case, perform the following operations. Press **TUNING PRESET**, then turn **SOURCE SELECT** to select the preset radio station.

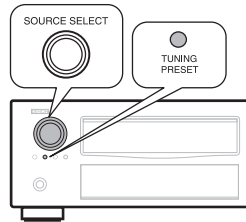

Direct frequency tuning

You can enter the receiving frequency directly to tune in.

- 1 Press **SEARCH**.
- 2 Input frequencies using the **0 - 9**.
 - If **<** is pressed, the immediately preceding input is cancelled.
- 3 When setting is completed, press **ENTER**.
The preset frequency is tuned in.



RDS (Radio Data System)

RDS (works only on the FM band) is a broadcasting service which allows a station to send additional information along with the regular radio program signal.

NOTE

The operations described as follows using **SEARCH** will not function in areas in which there are no RDS broadcasts.

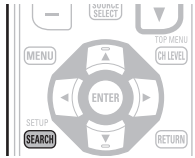

RDS search

Use this function to automatically tune to FM stations that provide the RDS service.

- 1 Press **TUNER** to switch the input source to “TUNER”.
- 2 Press **SEARCH** to select “RDS SEARCH”.

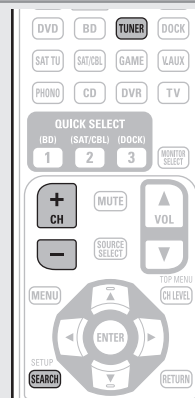
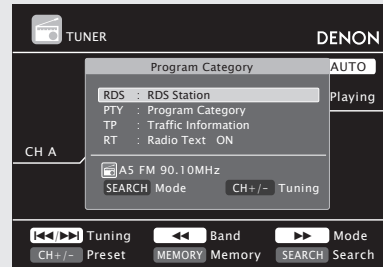

- 3 Press **CH +** or **CH -**.
The search for RDS stations begins automatically.

- If no RDS stations are found with the above operation, all the reception bands are searched.
- When a broadcast station is found, that station’s name appears on the display.
- If no RDS station is found when all the frequencies have been searched, “NO RDS” is displayed.

PTY (Program Type)

PTY identifies the type of RDS program. The program types and their displays are as follows:

NEWS	News	WEATHER	Weather
AFFAIRS	Current Affairs	FINANCE	Finance
INFO	Information	CHILDREN	Children’s program
SPORT	Sports	SOCIAL	Social Affairs
EDUCATE	Education	RELIGION	Religion
DRAMA	Drama	PHONE IN	Phone In
CULTURE	Culture	TRAVEL	Travel
SCIENCE	Science	LEISURE	Leisure
VARIED	Varied	JAZZ	Jazz Music
POP M	Pop Music	COUNTRY	Country Music
ROCK M	Rock Music	NATION M	National Music
EASY M	Easy Listening Music	OLDIES	Oldies Music
LIGHT M	Light Classical	FOLK M	Folk Music
CLASSICS	Serious Classical	DOCUMENT	Documentary
OTHER M	Other Music		

PTY search

Use this function to find RDS stations broadcasting a designated program type (PTY).

- 1 Press **TUNER** to switch the input source to “TUNER”.
- 2 Press **SEARCH** to select “PTY SEARCH”.

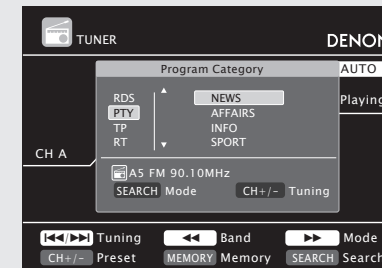

- 3 Watching the display, press **Δ**/**∇** to call out the desired program type.

Tuning in radio stations

4 Press **CH +** or **CH -**.
PTY search begins automatically.

- If there is no station broadcasting the designated program type with the above operation, all the reception bands are searched.
- The station name is displayed on the display after searching stops.
- If no station broadcasting the designated program type is found when all the frequencies have been searched, "NO PROGRAMME" is displayed.

TP (Traffic Program)

TP identifies programs that carry traffic announcements. This allows you to easily find out the latest traffic conditions in your area before leaving home.

TP search

Use this function to find RDS stations broadcasting traffic programs (TP stations).

1 Press **TUNER** to switch the input source to "TUNER".

2 Press **SEARCH** to select "TP SEARCH".

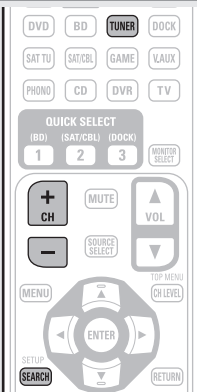
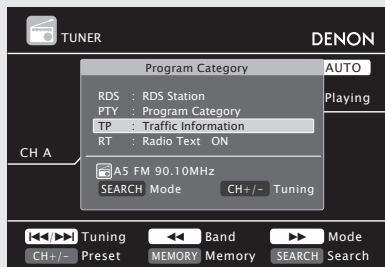

3 Press **CH +** or **CH -**.
TP search begins automatically.

- If no TP station is found with the above operation, all the reception bands are searched.
- The station name is displayed on the display after searching stops.
- If no other TP station is found when all the frequencies have been searched, "NO PROGRAMME" is displayed.

RT (Radio Text)

RT allows RDS stations to send text messages that appear on the display.

"RT" appears on the display when radio text data is received.

1 Press **TUNER** to switch the input source to "TUNER".

2 Press **SEARCH** to select "RT".

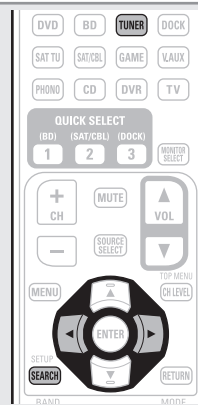
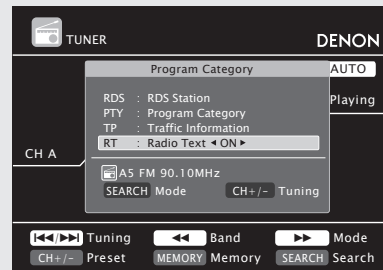

- While receiving an RDS broadcast station, the text data broadcast from the station is displayed.
- To turn the display off, press <|>.
- If no text data is being broadcast, "NO TEXT DATA" is displayed.

Tuner (FM/AM) operation

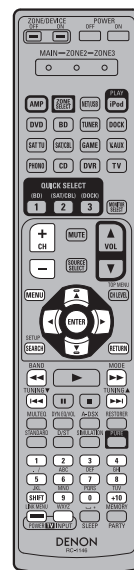

Operation buttons	Function
CH +, -	Preset channel selection
MENU	Amp menu
△▽◀▶	Cursor operation
ENTER	Enter setting
SEARCH	Direct frequency tuning / RDS search
RETURN	Return
BAND	FM/AM switching
MODE	Switch search modes
TUNING ▲▼	Tuning (up/down)
0 - 9	Preset channel selection (1 - 8) / Direct frequency tuning (0 - 9)
SHIFT	Preset channel block selection
MEMORY	Preset memory registration
TV POWER	TV power on/standby (Default : SONY)
TV INPUT	Switch TV input (Default : SONY)

Playing a network audio

Follow this procedure to play Internet radio stations or music or still picture (JPEG) files stored on a computer.

Important information

About the internet radio function

- Internet radio refers to radio broadcasts distributed over the Internet. Internet radio stations from around the world can be received.
- This unit is equipped with the following Internet radio functions:
 - Stations can be selected by genre and region.
 - Up to 56 Internet radio stations can be preset.
 - Internet radio stations in MP3 and WMA (Windows Media Audio) format can be listened to.
 - Your favorite radio stations can be registered by accessing an exclusive DENON Internet radio URL from a Web browser on a computer.
 - The function is managed for individual users, so you must provide your MAC or e-mail address. Exclusive URL: <http://www.radiodenon.com>
 - The radio station database service may be suspended without notice.
 - This unit's Internet radio station list is created using a radio station database service (vTuner). This database service provides a list edited and created for this unit.

Media player

- This function lets you play music files and playlists (m3u, wpl) stored on a computer (media server) connected to this unit via a network. With this unit's network audio playback function, connection to the server is possible using one of the technologies below.
- Windows Media Player Network Sharing Service
 - Windows Media DRM10

Album art function

When a WMA (Windows Media Audio), MP3 or MPEG-4 AAC file includes album art data, the album art can be displayed while the music files are playing.



For music files in WMA (Windows Media Audio) format, the album art is only played when using Windows Media Player ver. 11.

Slide show function

Still picture (JPEG) files stored in folders on a media server can be played as slide shows. The duration each picture is displayed can be set.



This unit plays back image (JPEG) files in the orientation in which they are stored in the folder.

[Compatible formats]

	Internet radio	Media server *1
WMA (Windows Media Audio)	✓	✓
MP3 (MPEG-1 Audio Layer-3)	✓	✓
WAV		✓
MPEG-4 AAC		✓ *2
FLAC (Free Lossless Audio Codec)		✓
JPEG		✓

A server or server software compatible with distribution in the corresponding formats is required to play music files via a network.

*1 Media server

- This unit is compatible with MP3 ID3-Tag (Ver. 2) standard.
- This unit can show the artwork that was embedded by using MP3 ID3-Tag Ver. 2.3 or 2.4.
- This unit is compatible with WMA META tags.
- WAV format Quantization bit rate: 16 bits.
- FLAC format Quantization bit rate: 16/24 bits.

*2 Only files that are not protected by copyright can be played on this unit.

Content downloaded from pay sites on the Internet are copyright protected. Also, files encoded in WMA format when ripped from a CD, etc. on a computer may be copyright protected, depending on the computer's settings.

[Compatible formats]

	Sampling frequency	Bit rate	Extension
WMA (Windows Media Audio)	32/44.1/48 kHz	48 – 192 kbps	.wma
MP3 (MPEG-1 Audio Layer-3)	32/44.1/48 kHz	32 – 320 kbps	.mp3
WAV	32/44.1/48 kHz	–	.wav
MPEG-4 AAC	32/44.1/48 kHz	16 – 320 kbps	.aac/ .m4a/ .mp4
FLAC (Free Lossless Audio Codec)	32/44.1/48/ 88.2/96 kHz	–	.flac

About Flickr

Flickr is an online photograph sharing service that started in 2004. You can use this unit to view photographs that have been made public by Flickr users. You do not need an account to use Flickr. To view photographs that you recorded yourself, you need an account in order to upload these photographs to the Flickr server. For details, see the Flickr homepage.
<http://www.flickr.com/>

About Napster

Napster is a monthly subscription music distribution service provided by Napster LLC. This service allows users to download and play pieces of music they want to hear on this unit. Before you can use Napster, you will need to visit the Napster website on your PC to create an account and register as a member. For details, access the following site:
http://www.napster.com/choose/index_default.html

About Last.fm

Last.fm learns what you love... and it's a great way to discover new music. Your new DENON AV receiver is very clever. You can create a free Last.fm profile when you start using your DENON AV receiver and magically keep track of all the songs you hear. When you sign in at www.last.fm, you can see your top music charts, view thousands of reviews, biographies and artwork, and get recommendations for local performances you won't want to miss. With an affordable subscription you can enjoy an endless choice of personalised ad-free radio stations. Check out www.last.fm subscribe today for more details. Your subscription also gives you access to Last.fm radio on a great range of music products, including your DENON AV Receiver. This feature is not available in all countries. Visit www.last.fm/hardware to find out more.

Playing a network audio

Listening to internet radio

1 Prepare for playback.

- ① Check the network environment, then turn on this unit's power (page 22 "Connecting to a home network (LAN)").
- ② If settings are required, make the "Network Connecting" (page 79).

2 Press NET/USB to switch the input source to "NET/USB".

3 Press Δ / ∇ to select "Internet Radio", then press ENTER or \triangleright .

- Selecting  in the "Source Select" menu, lets you directly select "Internet Radio".

4 Press Δ / ∇ to select the item you want to play, then press ENTER or \triangleright .

5 Repeat step 4 until the station list is displayed.

The station list is displayed.

6 Press Δ / ∇ to select the station, then press ENTER or \triangleright .

Playback starts once buffering reaches "100%".

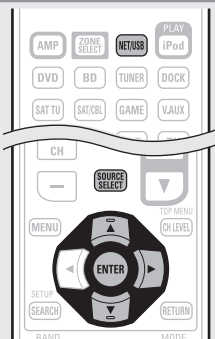

- You can specify the duration of the on-screen display to be displayed (default: 30 sec) at menu "NET/USB" (page 83. Press Δ / ∇ / \triangleright to return to the original screen.
- When **STATUS** is pressed, the display can be switched between the title name and radio station name.

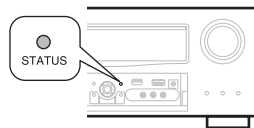

Recently played internet radio stations

Recently played internet radio stations can be selected from "Recently Played".
Up to 20 stations stored in "Recently Played".

1 Press Δ / ∇ to select "Recently Played", then press ENTER or \triangleright .

2 Press Δ / ∇ to select the item you want to play, then press ENTER or \triangleright .

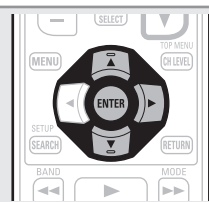

Searching stations by keyword (Alphabetic strings)

1 Press Δ / ∇ to select "Search by Keyword", then press ENTER or \triangleright .

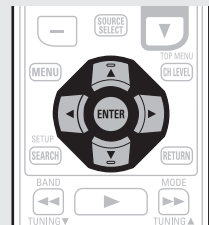
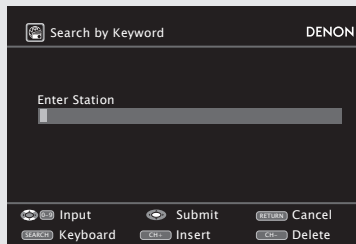

- For character input, see page 61.

2 Input the characters, then press ENTER.

Presetting internet radio stations

Preset Internet radio stations can be selected directly.

1 While the Internet radio station you want to preset is playing, press MEMORY.

2 Press Δ / ∇ to select "Preset", then press ENTER.

3 Press SHIFT, then press CH +, CH - or 1 - 8 to select the desired preset number.

4 Press MEMORY again to complete the setting.

The Internet radio station is now preset.



NOTE

If registered at a number that has already been preset, the previously registered setting is cleared.

Listening to preset internet radio stations

After pressing SHIFT, press CH +, CH - or 1 - 8 to select the registered preset number.

This unit automatically connects to the Internet and playback begins.

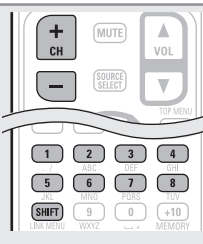

- There are many Internet radio stations on the Internet, and the quality of the programs they broadcast as well as the bit rate of the tracks varies widely. Generally, the higher the bit rate, the higher the sound quality, but depending on the communication lines and server traffic, the music or audio signals being streamed may be interrupted. Inversely, lower bit rates mean a lower sound quality but less tendency for the sound to be interrupted.
- "Server Full" or "Connection Down" is displayed if the station is busy or not broadcasting.
- On this unit, folder and file names can be displayed as titles. Any characters that cannot be displayed are replaced with "." (period).
- To play back compressed audio with extended bass or treble reproduction, we recommend playback in RESTORER mode (page 73. The default setting is "Mode3".

❑ Registering internet radio stations as your favorites

Favorites are listed at the top of the menu screen, so when a station is registered as a favorite it can be tuned in easily.

1 Press **MEMORY** while the Internet radio station you want to register is playing.

2 Press Δ / ∇ to select “Favorites”, then press **ENTER**.

3 Press \triangleleft to select “Add”.
The Internet radio station is registered.

• If you do not want to register the station, press \triangleright .

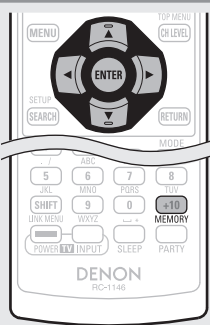

❑ Listening to internet radio stations registered in your favorites

1 Press **SOURCE SELECT** to display the Source Select menu, then select \triangleright (page 24).

2 Press Δ / ∇ to select the Internet radio station, then press **ENTER** or \triangleright .

This unit automatically connects to the Internet and playback begins.

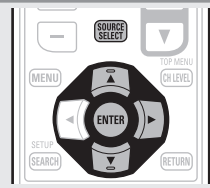

❑ Clearing internet radio stations from your favorites

1 Press **SOURCE SELECT** to display the Source Select menu, then select \triangleright (page 24).

2 Press Δ / ∇ to select the Internet radio station you want to clear, then press **MEMORY**.

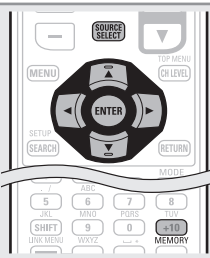

3 Press \triangleleft to select “Remove”.

The selected Internet radio station is cleared.

• To cancel the operation without clearing the station, press \triangleright .

❑ Internet radio operation



Operation buttons	Function
CH +, -	Preset channel selection
MENU	Amp menu
Δ / ∇ / \triangleleft / \triangleright	Cursor operation
ENTER (Press and release)	Enter
ENTER (Press and hold)	Stop
SEARCH	Page search *1 / Character search *2
RETURN	Return
\blacksquare	Stop
RESTORER	RESTORER
1 - 8	Preset channel selection
SHIFT	Preset channel block selection
MEMORY	Favorites / Preset memory registration
TV POWER	TV power on/standby (Default : SONY)
TV INPUT	Switch TV input (Default : SONY)

*1 When the menu screen is displayed, press **SEARCH**, then press \triangleleft (previous page) or \triangleright (next page).

To cancel, press Δ / ∇ or **SEARCH** twice.

*2 When the menu screen is displayed, press **SEARCH** twice, then press \triangleleft \triangleright to select the first letter you want to search mode.

• If it is not possible to search the list, “unsorted list.” is displayed.

To cancel, press Δ / ∇ or **SEARCH**.

If the list is not in alphabetical order, you may not be able to perform a character search.

Playing files stored on a computer

Use this procedure to play music files, image files or playlists.

1 Prepare for playback.

- Check the network environment, then turn on this unit's power (page 22 “Connecting to a home network (LAN)”).
- If settings are required, make the “Network Connecting” (page 79).
- Prepare the computer (Computer's operating instructions).

2 Press **SOURCE SELECT** to display the Source Select menu, then select \triangleright (page 24).

3 Press Δ / ∇ to select the server including the file to be played, then press **ENTER** or \triangleright .

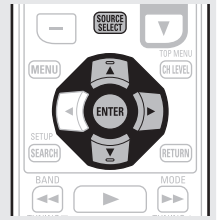

4 Press Δ / ∇ to select the search item or folder, then press **ENTER** or \triangleright .

5 Repeat step 4 until the file is displayed.

6 Press Δ / ∇ to select the file, then press **ENTER** or \triangleright .
Playback starts once buffering reaches “100%”.



- Connections to the required system and specific settings must be made in order to play music files (page 22).
- Before starting, you must launch the computer's server software and set the files as server contents. For details, see the operating instructions of your server software.
- Depending on the size of the still picture (JPEG) file, some time may be required for the file to be displayed.
- The order in which the tracks/files are displayed depends on the server specifications. If the tracks/ files are not displayed in alphabetical order due to the server specifications, searching by the first letter may not work properly.
- WMA Lossless files can be played when using a server supporting transcoding, such as Windows Media Player Ver. 11.

Playing a network audio



- To play back compressed audio with extended bass or treble reproduction, we recommend playback in RESTORER mode (☞ page 73). The default setting is “Mode3”.
- You can specify the duration of the on-screen display to be displayed (default: 30 sec) at menu “NET/USB” (☞ page 83). Press $\Delta \nabla \triangleleft \triangleright$ to return to the original screen.
- Use **STATUS** to switch between displaying the title name, artist name or album name.

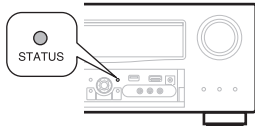

Playing files that have been preset or registered in your favorites

Files can be preset, registered in your favorites and played using the same operations as for Internet radio stations (☞ page 33).

NOTE

- Presettings are erased by overwriting them.
- When the operations described below is performed, the media server’s database is updated and it may no longer be possible to play preset or favorite music files.
 - When you quit the media server and then restart it.
 - When music files are deleted or added on the media server.

Media server operation



Operation buttons	Function
CH +, -	Preset channel selection
MENU	Amp menu
$\Delta \nabla \triangleleft \triangleright$	Cursor operation / Auto search (cue, $\Delta \nabla$)
ENTER (Press and release)	Enter / Pause
ENTER (Press and hold)	Stop
SEARCH	Page search *1 / Character search *2
RETURN	Return
\blacktriangleright	Playback / Pause
$\blacktriangleleft \blacktriangleright$	Auto search (cue)
\parallel	Pause
\blacksquare	Stop
RESTORER	RESTORER
1 - 8	Preset channel selection
SHIFT	Preset channel block selection
MEMORY	Favorites / Preset memory registration
TV POWER	TV power on/standby (Default : SONY)
TV INPUT	Switch TV input (Default : SONY)

- **Repeat playback** (☞ page 68 “Repeat”)
- **Random playback** (☞ page 68 “Random”)

- *1 When the menu screen is displayed, press **SEARCH**, then press \triangleleft (previous page) or \triangleright (next page).
To cancel, press $\Delta \nabla$ or **SEARCH** twice.
- *2 When the menu screen is displayed, press **SEARCH** twice, then press $\triangleleft \triangleright$ to select the first letter you want to search mode.
 - If it is not possible to search the list, “unsorted list.” is displayed.
 - To cancel, press $\Delta \nabla$ or **SEARCH**.

If the list is not in alphabetical order, you may not be able to perform a character search.

Viewing photographs on the Flickr site

You can view photographs shared by particular users, or all of the photographs shared on Flickr.

Viewing photographs shared by particular users

- 1 Prepare for playback.**
 - ① Check the network environment, then turn on this unit’s power (☞ page 22 “Connecting to a home network (LAN)”).
 - ② If settings are required, make the “Network Connecting” (☞ page 79).

- 2 Press SOURCE SELECT to display the Source Select menu, then select flickr (☞ page 24).**

- 3 Use $\Delta \nabla$ to select “Add Flickr Contact”, then press ENTER or \triangleright .**

- 4 Enter “Username”.**
 - For character input, see page 61.

- 5 After inputting the “Username”, then press ENTER.**

The “User Name” entered in step 4 is displayed.

 - If the Username you typed in cannot be found, “The Flickr Contact you entered could not be found” appears. Check and type in the correct Username.

6 Press Δ / ∇ to select the folder, and then press **ENTER** or \triangleright .

Favorites Displays the favorite photographs of the specified user.

Photostream Displays a list of shared photographs.

PhotoSets Displays the folder (photograph album) list.

Contacts Displays a Username registered for Flickr Contact by a particular user.

Remove this Contact Deletes a user from Flickr Contact.

7 Press Δ / ∇ to select the file, and then press **ENTER** or \triangleright .
The selected file is displayed.

Viewing all photographs on Flickr

- 1 Prepare for playback.**
 - Check the network environment, then turn on this unit's power (page 22 "Connecting to a home network (LAN)").
 - If settings are required, make the "Network Connecting" (page 79).

2 Press **SOURCE SELECT** to display the Source Select menu, then select **flickr** (page 24).

3 Use Δ / ∇ to select "All Content", then press **ENTER** or \triangleright .

4 Press Δ / ∇ to select the folder, and then press **ENTER** or \triangleright .

Interestingness Displays photographs that are popular from the number of user comments or number of times they are added as favorites.

Recent Displays the most recently added photographs.

Search by text Search for photographs by keyword.

5 Press Δ / ∇ to select the file, and then press **ENTER** or \triangleright .
The selected file is displayed.

NOTE
Depending on the file format, some photographs cannot be viewed.

Flickr operation



Operation buttons	Function
CH +, -	Preset channel selection
MENU	Amp menu
Δ / ∇ / \triangleleft / \triangleright	Cursor operation / Auto search (cue, Δ / ∇)
ENTER (Press and release)	Enter
ENTER (Press and hold)	Stop
SEARCH	Page Search *
RETURN	Return
■	Stop
1 - 8	Preset channel selection
SHIFT	Preset channel block selection
TV POWER	TV power on/standby (Default : SONY)
TV INPUT	Switch TV input (Default : SONY)

* When the menu screen is displayed, press **SEARCH**, then press \triangleleft (previous page) or \triangleright (next page).
To cancel, press Δ / ∇ or **SEARCH**.

Listening to Napster

- 1 Prepare for playback.**
 - Check the network environment, then turn on this unit's power (page 22 "Connecting to a home network (LAN)").
 - If settings are required, make the "Network Connecting" (page 79).

2 Press **SOURCE SELECT** to display the Source Select menu, then select **flickr** (page 24).

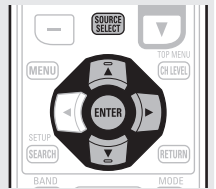

3 Use Δ / ∇ / \triangleright to input "Username" and "Password".

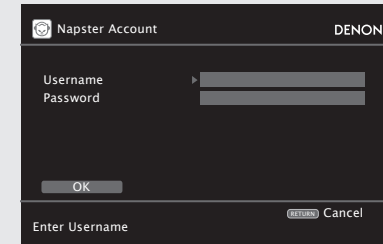

• For character input, see page 61.

4 After inputting the "Username" and "Password", select "OK", then press **ENTER**.
If the "Username" and "Password" match, the top menu for Napster is displayed.

NOTE

- The password should be no longer than 99 characters.
- Press **RETURN** to cancel the input. When "Cancel input?" is displayed, select "Yes", then press **ENTER**.

Playing a network audio

❑ Searching from Napster menu

- 1 Use Δ / ∇ to select search item or folder, then press **ENTER** or \triangleright .
- 2 Repeat step 1 until the track is displayed.
- 3 Use Δ / ∇ to select the track item, then press **ENTER** or \triangleright .

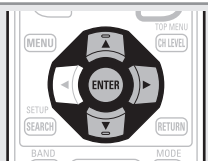

❑ Entering a character search for the track you want to listen to

- 1 Press **SEARCH**.

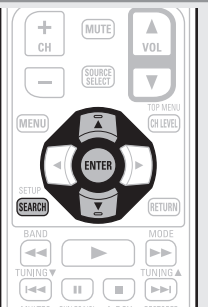
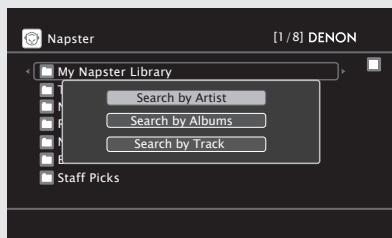

- You can search by artist name, album name or track name.

- 2 Use Δ / ∇ to select the search item, then press **ENTER**. The search display appears.

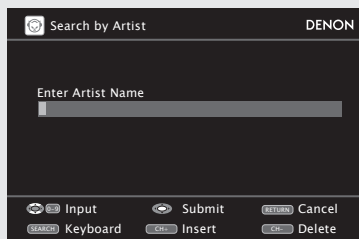

- For character input, see page 61.

- 3 Input the characters, then press **ENTER**.

❑ Registering tracks in my Napster library

- 1 Press \triangleright while the track you wish to register is playing.
- 2 Select “Add to my library”, then press **ENTER** or \triangleright . The track is entered in the Library.

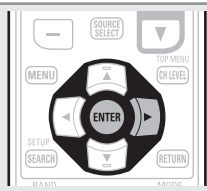

❑ Listening to tracks registered in my Napster library

- 1 Use Δ / ∇ to select “My Napster Library”, then press **ENTER** or \triangleright .
- 2 Use Δ / ∇ to select the information or track, then press **ENTER**.

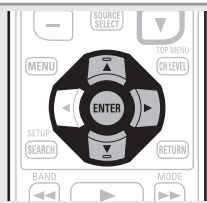

- To play back compressed audio with extended bass or treble reproduction, we recommend playback in RESTORER mode (☞ page 73). The default setting is “Mode3”.
- You can specify the duration of the on-screen display to be displayed (default: 30 sec) at menu “NET/USB” (☞ page 83). Press Δ / ∇ / \triangleleft / \triangleright to return to the original screen.
- Use **STATUS** to switch between displaying the title name, artist name or album name.



❑ Napster operation



Operation buttons	Function
CH +, -	Preset channel selection
MENU	Amp menu
Δ / ∇ / \triangleleft / \triangleright	Cursor operation / Auto search (cue, Δ / ∇)
ENTER (Press and release)	Enter / Pause
ENTER (Press and hold)	Stop
SEARCH	Search menu / Page search *
RETURN	Return
\blacktriangleright	Playback / Pause
\blacktriangleleft / \blacktriangleright	Auto search (cue)
\blacksquare	Stop
RESTORER	RESTORER
1 - 8	Preset channel selection
SHIFT	Preset channel block selection
TV POWER	TV power on/standby (Default : SONY)
TV INPUT	Switch TV input (Default : SONY)

- **Repeat playback** (☞ page 68 “Repeat”)
- **Random playback** (☞ page 68 “Random”)

* When the menu screen is displayed, press **SEARCH** twice, then press \triangleleft (previous page) or \triangleright (next page). To cancel, press Δ / ∇ or **SEARCH**.

How to listen to Last.fm on this unit

Last.fm radio is not available in all countries. Please check www.last.fm/hardware for more information. You'll also need a subscription. Get one today at www.last.fm/subscribe.

1 Prepare for playback.

- ① Make sure this unit is connected to the Internet, then turn on this unit's power (☞ page 22 "Connecting to a home network (LAN)").
- ② If settings are required, follow the "Network Connecting" (☞ page 79).

2 Press SOURCE SELECT to display the Source Select menu, then select (☞ page 24).



- If you do not have a Last.fm account, press ∇ to select "I am new to Last.fm". Then press **ENTER**. Create an account in accordance with the instructions on the screen.

3 If you have a Last.fm account, press $\triangle\nabla$ to select "I have a Last.fm account". Then press **ENTER** or \triangleright .

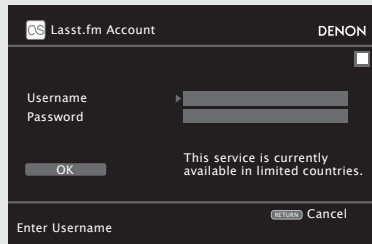

4 Use $\triangle\nabla\triangleright$ to enter your username and password.

- For character input, see page 61.

5 After inputting the username and password, select "OK", then press **ENTER**.

If the username and password match, the top menu for Last.fm is displayed.

- The types of characters that can be input are as shown below.

Username:	
[Upper case characters]	ABCDEFGHIJKLMN OP QRSTUVWXYZ
[Lower case characters]	abcdefghijklm no pqrstuvwxyz
[Symbols]	_ -
[Numbers]	0123456789
Password:	
[Upper case characters]	ABCDEFGHIJKLMN OP QRSTUVWXYZ
[Lower case characters]	abcdefghijklm no pqrstuvwxyz
[Symbols]	!#" \$% &' () * +, - . / : ; < = > ? @ [\] ^ ` { } ~ (Space)
[Numbers]	0123456789

6 Use $\triangle\nabla$ to select menu and then press **ENTER**.

Popular Stations Play popular artists and tags in your area.

You Recent Stations Play your recent stations.

Your stations You can play tracks from the following personalised stations ("Your Recommended Radio", "Your Library", "Your Neighborhood", "Your Friends' Radio", "Your Top Tags", "Your Top Artists").

Search Stations You can search station by Artist or Tag.

7 Use $\triangle\nabla$ to select a station, and press **ENTER** or **PLAY** to start playback.

Playback starts and the following screen appears.

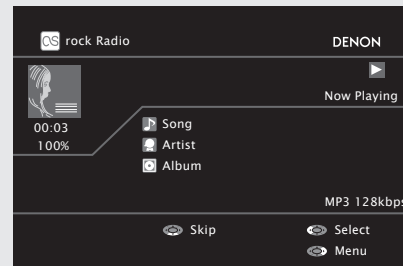

8 Menu items on playback screen.

Love this track Loving tracks improves your Last.fm recommendations, and you can optionally share them on popular social networks.

Ban this track If you ban a track, we won't play it again. You can undo this on the Last.fm website.

Scrobbling Scrobbling sends the tracks you played to your Last.fm account. You can see charts of the music you've been listening to, get recommendations for new music and events in your area and share your listening tastes with your friends. You can turn this service on or off using this option. The more you scrobble, the better your recommendations will become.

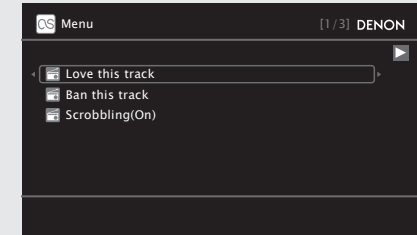

NOTE

- The password should be no longer than 99 characters.
- Press **RETURN** to cancel the input. When "Cancel input?" is displayed, select "Yes", then press **ENTER**.



- To play back compressed audio with extended bass or treble reproduction, we recommend playback in RESTORER mode (☞ page 73). The default setting is "Mode3".
- You can specify the duration of the on-screen display to be displayed (default: 30 sec) at menu "NET/USB" (☞ page 83). Press $\triangle\nabla\triangleleft\triangleright$ to return to the original screen.
- Use **STATUS** to switch between displaying the title name, artist name or album name.

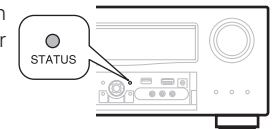

Playing a network audio

❑ Last.fm operation



Operation buttons	Function
MENU	Amp menu
△▽◀▶	Cursor operation / Auto search (cue, ▽)
ENTER (Press and release)	Enter
ENTER (Press and hold)	Stop
SEARCH	Page search *
RETURN	Return
▶	Playback
▶▶	Auto search (cue)
■	Stop
RESTORER	RESTORER
TV POWER	TV power on/standby (Default : SONY)
TV INPUT	Switch TV input (Default : SONY)

* When the menu screen is displayed, press **SEARCH**, then press ◀ (previous page) or ▶ (next page).
To cancel, press △▽ or **SEARCH**.

Playing a USB memory device

Playing back music or still picture (JPEG) files recorded on a USB memory device.

Important information

❑ USB memory devices

A USB memory device can be connected to the USB port of this unit to play music and still picture (JPEG) files stored on the USB memory device.

Also, files stored on an iPod can be played when the iPod is connected directly to the USB port of this unit. See "Connect an iPod directly to the USB port to play back" (page 27).

- Only USB memory devices conforming to mass storage class and MTP (Media Transfer Protocol) standards can be played on this unit.
- This unit is compatible with USB memory devices in "FAT16" or "FAT32" format.

Album art function

When an MP3 music file includes album art data, the album art can be displayed while playing the file.

Slide show function

Still picture (JPEG) files stored on USB memory devices can be played as slide shows.
The duration each picture is displayed can be set.



This unit plays back image (JPEG) files in the orientation in which they are stored in the folder.

[Compatible formats]

	USB memory devices *1
WMA (Windows Media Audio)	✓ *2
MP3 (MPEG-1 Audio Layer-3)	✓
WAV	✓
MPEG-4 AAC	✓ *3
FLAC (Free Lossless Audio Codec)	✓
JPEG	✓

*1 USB

- This unit is compatible with MP3 ID3-Tag (Ver. 2) standard.
- This unit can show the artwork that was embedded by using MP3 ID3-Tag Ver. 2.3 or 2.4.
- This unit is compatible with WMA META tags.
- WAV format Quantization bit rate: 16 bits.
- FLAC format Quantization bit rate: 16/24 bits.

*2 Copyright-protected files can be played on certain portable players compatible with MTP.

*3 Only files that are not protected by copyright can be played on this unit.

Content downloaded from pay sites on the Internet are copyright protected. Also, files encoded in WMA format when ripped from a CD, etc. on a computer may be copyright protected, depending on the computer's settings.

[Compatible formats]

	Sampling frequency	Bit rate	Extension
WMA (Windows Media Audio)	32/44.1/48 kHz	48 – 192 kbps	.wma
MP3 (MPEG-1 Audio Layer-3)	32/44.1/48 kHz	32 – 320 kbps	.mp3
WAV	32/44.1/48 kHz	–	.wav
MPEG-4 AAC	32/44.1/48 kHz	16 – 320 kbps	.aac/ .m4a/ .mp4
FLAC (Free Lossless Audio Codec)	32/44.1/48/ 88.2/96 kHz	–	.flac

Playing files stored on USB memory devices

1 Connect the USB memory device to the USB port (page 19 “Connecting an iPod or USB memory device to the USB port”).

2 Press **NET/USB** to switch the input source to “NET/USB”.

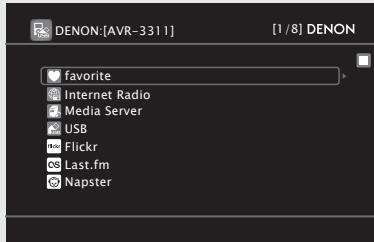

3 Use Δ / ∇ to select “USB”, then press **ENTER** or \triangleright .

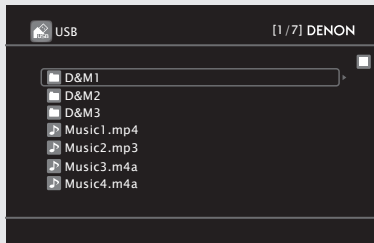

• Selecting  in the “Source Select” menu, lets you directly select “USB”.

4 Press Δ / ∇ to select the search item or folder, then press **ENTER** or \triangleright .

5 Press Δ / ∇ to select the file, then press **ENTER**, \triangleright or \blacktriangleright .
Playback starts.



- You can specify the duration of the on-screen display to be displayed (default: 30 sec) at menu “NET/USB” (page 83). Press Δ / ∇ / \triangleleft / \triangleright to return to the original screen.
- To play back compressed audio with extended bass or treble reproduction, we recommend playback in RESTORER mode (page 73). The default setting is “Mode3”.
- If the USB memory device is divided into multiple partitions, only the top partition can be selected.
- This unit is compatible with MP3 files conforming to “MPEG-1 Audio Layer-3” standards.
- When **USB** on the sub remote control unit is pressed, playback starts from the first file stored on the USB memory device.

NOTE

- Note that DENON will accept no responsibility whatsoever for any problems arising with the data on a USB memory device when using this unit in conjunction with the USB memory device.
- USB memory devices will not work via a USB hub.
- DENON does not guarantee that all USB memory devices will operate or be supplied power. When using a USB portable hard disk that can draw power from an AC adapter, we recommend using the AC adapter.
- It is not possible to connect and use a computer via the USB port of this unit using a USB cable.

USB operation



Operation buttons	Function
CH +, -	Preset channel selection
MENU	Amp menu
Δ / ∇ / \triangleleft / \triangleright	Cursor operation / Auto search (cue, Δ / ∇)
ENTER (Press and release)	Enter / Pause
ENTER (Press and hold)	Stop
SEARCH	Page search *1 / Character search *2
RETURN	Return
\blacktriangleright	Playback / Pause
\lll / \ggg	Auto search (cue)
\parallel	Pause
\blacksquare	Stop
RESTORER	RESTORER
1 - 8	Preset channel selection
SHIFT	Preset channel block selection
TV POWER	TV power on/standby (Default : SONY)
TV INPUT	Switch TV input (Default : SONY)

- **Repeat playback** (page 68 “Repeat”)
- **Random playback** (page 68 “Random”)

*1 When the menu screen is displayed, press **SEARCH**, then press \triangleleft (previous page) or \triangleright (next page).

To cancel, press Δ / ∇ or **SEARCH** twice.

*2 When the menu screen is displayed, press **SEARCH** twice, then press \triangleleft / \triangleright to select the first letter you want to search mode.

• If it is not possible to search the list, “unsorted list.” is displayed.

To cancel, press Δ / ∇ or **SEARCH**.



If the list is not in alphabetical order, you may not be able to perform a character search.

Selecting a listening mode (Surround mode)

This unit can play input audio signals in multi-channel surround mode or in stereo mode. Select a listening mode suitable for the playback contents (cinema, music, etc.) or according to your liking.

Listening mode

Input audio signal	Playback	Listening mode	
2-channel Multi channel		Standard playback (🔧 page 40)	For 2-channel signal input: • Surround-channel signals are created and played with surround playback. For multichannel signal input: • The surround signal recorded in source is played as surround playback. (The sound is played according to the settings of the speaker size in "Speaker Config." (🔧 page 75).) • Surround-back-channel or front-height-channel signals that are not recorded in source can be created.
2-channel Multi channel		DENON original surround playback (🔧 page 42)	The surround effects suitable for the source type or according to your liking can be selected from the DENON original sound mode and is used for playback.
2-channel Multi channel		Stereo playback (🔧 page 42)	• If multichannel signals are input, they are mixed down to 2-channel audio and are played. • Subwoofer signals are also output.
2-channel Multi channel		Direct playback (🔧 page 42)	Sound recorded in source is played as is. • Surround back signals or front height signals are not created. • In this mode, the following items cannot be adjusted. • Tone (🔧 page 70) • MultEQ® XT (🔧 page 71) • Dynamic EQ® (🔧 page 71) • Dynamic Volume® (🔧 page 72) • RESTORER (🔧 page 73)
2-channel Multi channel		Pure direct playback (🔧 page 42)	This mode is for playback in higher sound quality than in "Direct playback" mode. The following circuits that affect sound quality are set to off. • Main unit's display circuit (The display is turned off.) • Analog video input/output circuit

- Some listening modes cannot be selected, depending on the audio format or number of channels of the input signal. For details, see "Types of input signals, and corresponding surround modes" (🔧 page 103).
- Adjust the sound field effect with the menu "Surround Parameter" (🔧 page 69) to enjoy your favorite sound mode.

Standard playback

Surround playback of 2-channel sources

1 Playing the source (🔧 page 25 – 39).

2 Press **STANDARD** to select the surround decoder to play back multichannel sound.



- If **STANDARD** on the main unit is pressed, the same function as with the remote control unit can be obtained.
- Each time **STANDARD** is pressed, the surround mode is switched. Which decoder can be selected depends on the settings of "Amp Assign" (🔧 page 75) or "Speaker Config." (🔧 page 75).

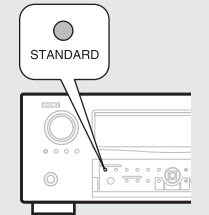

DOLBY PLIIz *1 This mode is for 7.1-channel surround playback using the front height speakers.
 • "PLIIz Height" is displayed.

DOLBY PLIIx *2 This mode is for 7.1-channel or 6.1-channel surround playback using the surround back speakers.
 • "PLIIx Cinema", "PLIIx Music" or "PLIIx Game" is displayed.

DOLBY PLII This mode is for 5.1-channel surround playback. Select this mode if no front height speaker nor surround back speaker is to be used.
 • "PLII Cinema", "PLII Music", "PLII Game" or "Pro Logic" is displayed.

DTS NEO:6 This mode is for 7.1-channel, 6.1-channel or 5.1-channel surround playback using the surround back speakers.
 • "DTS NEO:6 cinema" or "DTS NEO:6 music" is displayed.

*1 This can be selected when "Amp Assign" is set to "Normal" or "Speaker Config." – "F.Height" is not set to "None".
 *2 This can be selected when "Amp Assign" is set to "Normal" or "Speaker Config." – "S.Back" is not set to "None".

3 Select the mode corresponding to the playback contents with the menu “Surround Parameter” – “Mode” (page 69) to enjoy your favorite sound mode.

- Cinema** This mode is suited for movie sources.
- Music** This mode is suited for music sources. More sound is sent to the front speakers than in “Cinema” mode.
- Game** This mode is suited for games.
- Pro Logic** This mode is suitable for playback of 2-channel sources recorded with Dolby Pro Logic.
- Height** * This mode is for the surround decoder “Dolby PLIIz”. If the surround decoder is “Dolby PLIIx”, another mode cannot be selected.

• If the menu “Surround Parameter” – “F.Height” (page 69) is set to “ON”, the mode is switched to “Height” mode.

[Views on the display]

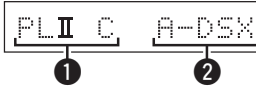

- 1 Shows a decoder to be used.
- 2 Shows a Audyssey DSX™ processing.

Surround playback of multi-channel sources (Dolby Digital, DTS etc.)

1 Playing the source (page 25 – 39).

2 Press STANDARD to select the surround decoder to play back multichannel sound.



- If **STANDARD** on the main unit is pressed, the same function as with the remote control unit can be obtained.
- Select the surround mode while viewing the display on the screen (page “Displaying the currently playing surround mode” at right).

• Which decoder can be selected depends on the input signal, the settings of “Amp Assign” (page 75) or “Speaker Config.” (page 75).

Displaying the currently playing surround mode

Input signal	Surround mode	Display
DOLBY DIGITAL (other than 2ch) / DOLBY DIGITAL EX	DOLBY DIGITAL	DOLBY DIGITAL
	DOLBY DIGITAL EX	DOLBY DIGITAL EX
	DOLBY DIGITAL + PLIIx CINEMA	DOLBY D + PLIIx C
	DOLBY DIGITAL + PLIIx MUSIC	DOLBY D + PLIIx M
	DOLBY DIGITAL + PLIIz HEIGHT	DOLBY D + PLIIz
DOLBY DIGITAL Plus	DOLBY DIGITAL Plus	DOLBY DIGITAL +
	DOLBY DIGITAL Plus + EX	DOLBY D + + EX
	DOLBY DIGITAL Plus + PLIIx CINEMA	DOLBY D + + PLIIx C
	DOLBY DIGITAL Plus + PLIIx MUSIC	DOLBY D + + PLIIx M
	DOLBY DIGITAL Plus + PLIIz HEIGHT	DOLBY D + + PLIIz
DOLBY TrueHD	DOLBY TrueHD	DOLBY TrueHD
	DOLBY TrueHD + EX	DOLBY HD +EX
	DOLBY TrueHD + PLIIx CINEMA	DOLBY HD +PLIIx C
	DOLBY TrueHD + PLIIx MUSIC	DOLBY HD +PLIIx M
	DOLBY TrueHD + PLIIz HEIGHT	DOLBY HD +PLIIz
DTS (5.1ch) / DTS-ES Discrete 6.1 / DTS-ES Matrix 6.1 / DTS 96/24	DTS SURROUND	DTS SURROUND
	DTS + PLIIx CINEMA	DTS + PLIIx C
	DTS + PLIIx MUSIC	DTS + PLIIx M
	DTS + PLIIz HEIGHT	DTS + PLIIz
	DTS + NEO:6	DTS + NEO:6
	DTS ES MTRX6.1*1	DTS ES MTRX6.1
	DTS ES DSCRT6.1*2	DTS ES DSCRT6.1
	DTS 96/24*3	DTS 96/24
DTS-HD	DTS-HD HI RES	DTS-HD HI RES
	DTS-HD MSTR	DTS-HD MSTR
	DTS-HD + NEO:6	DTS-HD + NEO:6
	DTS-HD + PLIIx CINEMA	DTS-HD + PLIIx C
	DTS-HD + PLIIx MUSIC	DTS-HD + PLIIx M
	DTS-HD + PLIIz HEIGHT	DTS-HD + PLIIz
	DTS Express	DTS Express
PCM (multi ch)	MULTI CH IN	MULTI CH IN
	MULTI IN + Dolby EX	MULTI +Dolby EX
	MULTI IN + PLIIx CINEMA	MULTI IN +PLIIx C
	MULTI IN + PLIIx MUSIC	MULTI IN +PLIIx M
	MULTI IN + PLIIz HEIGHT	MULTI IN +PLIIz
MULTI CH IN 7.1	MULTI CH IN 7.1	
All signals indicated above	Audyssey DSX*4	Audyssey DSX

- *1 This is displayed when the input signal is “DTS-ES Matrix 6.1” and this unit’s “AFDM” (page 70) setting is “ON”.
- *2 This is displayed when the input signal is “DTS-ES Discrete 6.1”.
- *3 This is displayed when the input signal is “DTS 96/24”.
- *4 This surround mode is displayed when “Audyssey DSX” (page 72) is set to “ON-Height-” or “ON-Wide-”.

[Views on the display]



- 1 Shows a decoder to be used.
 - A DOLBY DIGITAL Plus decoder is displayed as “DOLBY D +”.
- 2 Shows a decoder that creates sound output from the surround back speakers.
 - “+ PLIIz” indicates the front height sound from front height speakers.



For an input signal that can be reproduced in each surround mode, see “Surround modes and parameters” (page 101).

DENON original surround playback

1 Playing the source (☞ page 25 – 39).

2 Press **SIMULATION** to select the surround mode.

- If **DSP SIMULATION** on the main unit is pressed, the same function as with the remote control unit can be obtained.
- Each time **SIMULATION** is pressed, the surround mode is switched.

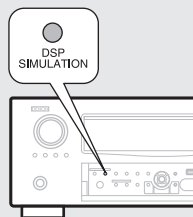

MULTI CH STEREO	This mode is for enjoying stereo sound from all speakers.
ROCK ARENA	This mode is for enjoying the atmosphere of a live concert in an arena.
JAZZ CLUB	This mode is for enjoying the atmosphere of a live concert in a jazz club.
MONO MOVIE *	This mode is for playing monaural movie sources with surround sound.
VIDEO GAME	This mode is suited for achieving surround sound with video games.
MATRIX	This mode lets you add a spacious feel to stereo music sources.
VIRTUAL	This mode is for enjoying surround effects using only the front speakers or headphones.

* When playing sources recorded in monaural in the “MONO MOVIE” mode, the sound will be off balance with a single channel (left or right), so input to both channels.



Depending on the program source being played, it may not be possible to achieve a satisfactory surround effect. In this case, try other modes to achieve a sound field suited to your tastes.

NOTE

When the input signal is Dolby TrueHD, Dolby Digital Plus, DTS-HD or DTS Express, you cannot select DENON original surround mode.

Stereo playback

This is the mode for playing in stereo. The tone can be adjusted.

- Sound is output from the front left and right speakers and subwoofer.
- If multichannel signals are input, they are mixed down to 2-channel audio and are played.

1 Playing the source (☞ page 25 – 39).

2 Press **D/ST** to select “STEREO”. Stereo playback begins.

- If **DIRECT/STEREO** on the main unit is pressed, the same function as with the remote control unit can be obtained.

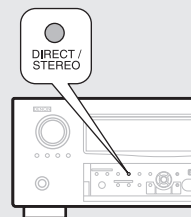

Direct playback

Sound recorded in source is played as is.

- Surround back signals or front height signals are not created.
- In this mode, the following items cannot be adjusted.
 - Tone (☞ page 70)
 - MultEQ® XT (☞ page 71)
 - Dynamic EQ® (☞ page 71)
 - Dynamic Volume® (☞ page 72)
 - RESTORER (☞ page 73)

1 Playing the source (☞ page 25 – 39).

2 Press **D/ST** to select “DIRECT”. Direct playback begins.

- If **DIRECT/STEREO** on the main unit is pressed, the same function as with the remote control unit can be obtained.

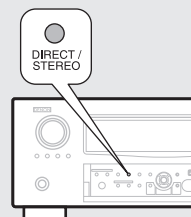

Pure direct playback

This mode is for playback in higher sound quality than in “Direct playback” mode.

- The following circuits that affect sound quality are set to off.
 - Main unit’s display circuit (The display is turned off.)
 - Analog video input/output circuit
- Surround back signals or front height signals are not created.
- In this mode, the following items cannot be adjusted.
 - Tone (☞ page 70)
 - MultEQ® XT (☞ page 71)
 - Dynamic EQ® (☞ page 71)
 - Dynamic Volume® (☞ page 72)
 - RESTORER (☞ page 73)

1 Playing the source (☞ page 25 – 39).

2 Press **PURE**. The display goes dark, and pure direct playback begins.

- If **PURE DIRECT** on the main unit is pressed, the same function as with the remote control unit can be obtained.

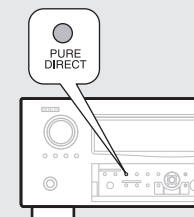





- To cancel, press **PURE** again.
- Video signals are only output when HDMI signals are played in the PURE DIRECT mode.

NOTE

When in the PURE DIRECT mode, the menu screen is not displayed.

Advanced version

Here, we explain functions and operations that let you make better use of this unit.

- **Speaker installation/connection (Advanced connection)**  **page 44**
- **Playback (Advanced operation)**  **page 50**
- **Playback in ZONE2/ZONE3 (Separate room)**  **page 57**
- **How to make detailed settings**  **page 59**
- **Operating the connected devices by remote control unit**  **page 87**

Speaker installation/connection (Advanced connection)

This section provides the installation, connection, and setup methods of speaker systems other than the 7.1-channel system (with surround back speakers).

For the speaker installation, connection, and setup methods of the 7.1-channel system with surround back speakers, see "Simple version (Simple setup guide)" (page 3).

Use the Audyssey® Auto Setup function of this unit to automatically detect the number of connected speakers and perform optimal settings for the speakers to be used.

Procedure for speaker settings

Install

Connect (page 45)

Set up speakers (page 48)

Install

This unit is compatible with Audyssey DSX™ (page 106) and Dolby Pro Logic IIz (page 107), which offers an even wider and deeper surround sensation. When using Audyssey DSX, install front wide speakers or front height speakers. When using Dolby Pro Logic IIz, install front height speakers.



Install the surround back speakers in a position 60 to 90 cm higher than ear level.

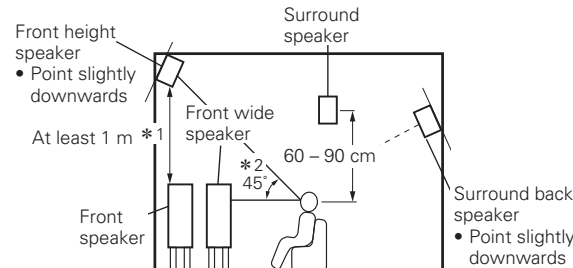

[Viewed from the side]

- *1 Recommended for Dolby Pro Logic IIz
- *2 Recommended for Audyssey DSX

NOTE

Sound is not output simultaneously from the surround back speakers, front height speakers, and front wide speakers. You can switch between speakers by changing the settings in surround mode or Audyssey DSX.

When 7.1ch (Surround back / Front height / Front wide speaker) installed

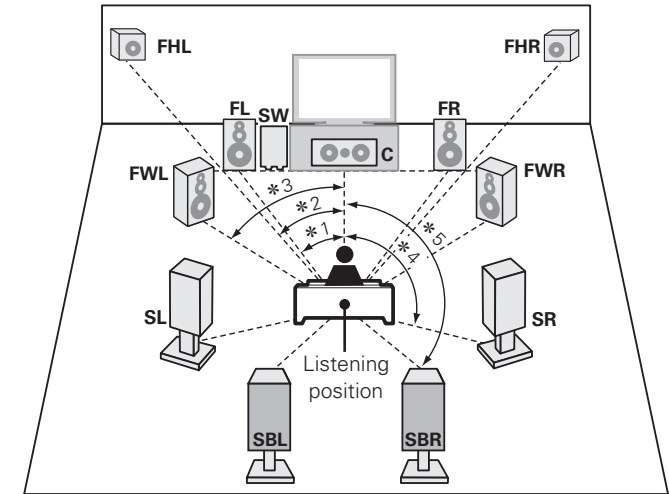

- *1 22° – 30°
- *2 22° – 45°
- *3 55° – 60°
- *4 90° – 110°
- *5 135° – 150°

When 6.1ch (Surround back speaker) installed

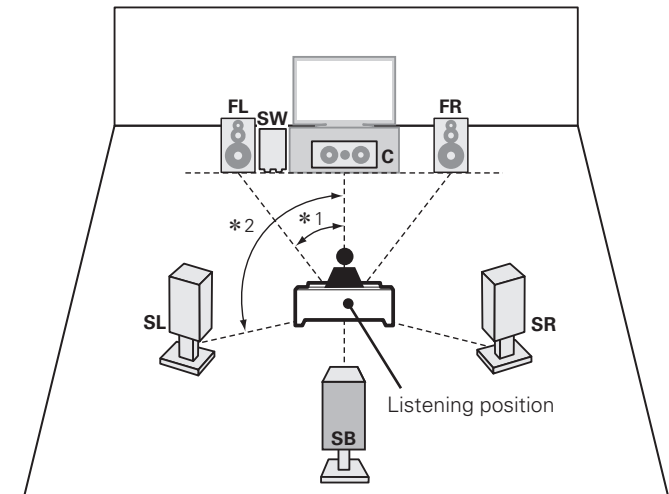

- *1 22° – 30°
- *2 90° – 110°

When 5.1ch installed

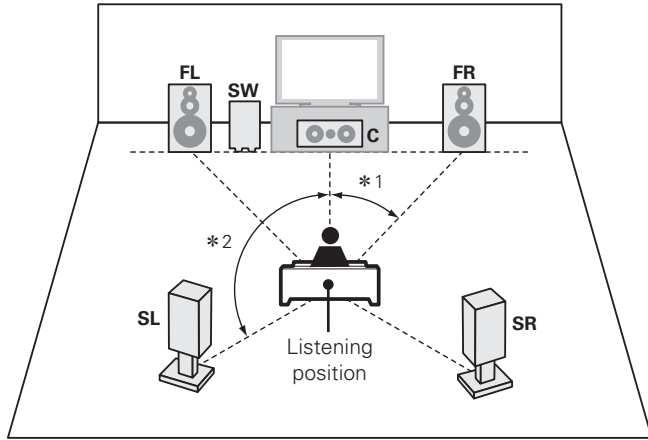

*1 22° - 30° *2 120°

When Front A/B speakers installed

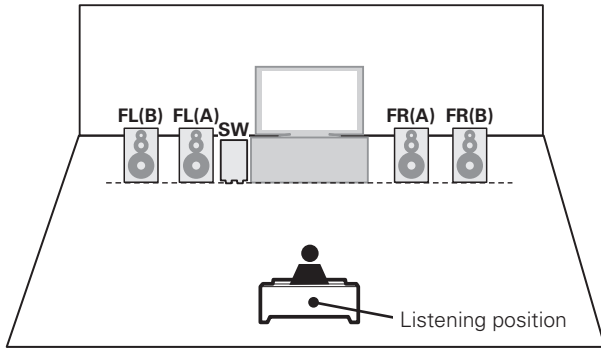

- | | |
|---------------------------------|--------------------------------------|
| FL Front speaker (L) | SBL Surround back speaker (L) |
| FR Front speaker (R) | SBR Surround back speaker (R) |
| C Center speaker | FHL Front height speaker (L) |
| SW Subwoofer | FHR Front height speaker (R) |
| SL Surround speaker (L) | FWL Front wide speaker (L) |
| SR Surround speaker (R) | FWR Front wide speaker (R) |
| SB Surround back speaker | |

Connect

- For the method of connecting the 7.1-channel system with surround back speakers, see page 4.
- For the method of connecting the TV, see page 5.

7.1-channel (Surround back / Front height / Front wide speaker) connection

For 7.1-channel (Surround back / Front height / Front wide speaker) playback, set "Set up "Amp Assign"" (page 49) to "Normal".

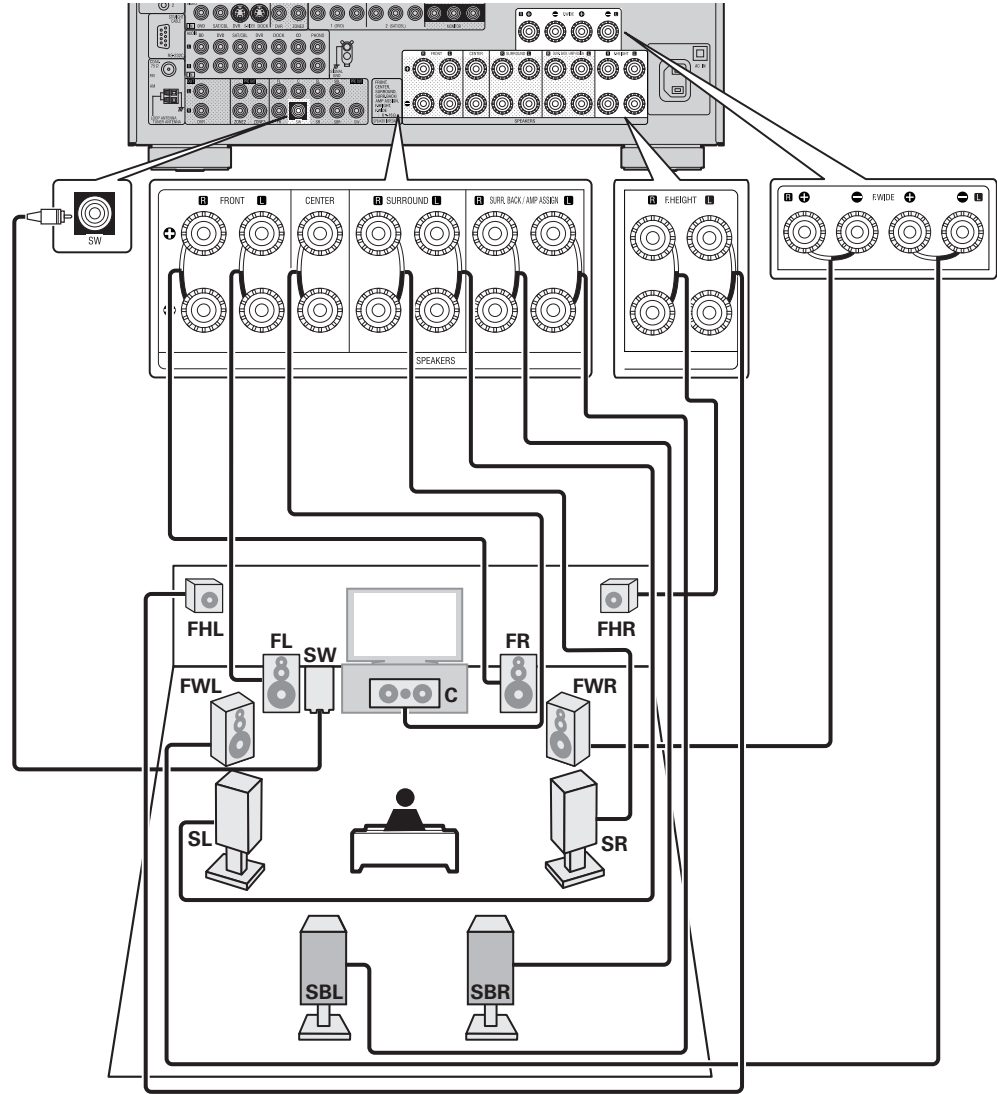

For speaker impedance and speaker cable connections, see page 4.

Connect

6.1-channel (Surround back speaker) connection

If using only one surround back speaker (with a 6.1-channel connection), connect to the "L" side of the SURR. BACK/AMP ASSIGN terminal.

For speaker settings in this case, see "When 6.1ch (Surround back speaker) installed" (page 44).

For 6.1-channel (Surround back speaker) playback, set "Set up "Amp Assign"" (page 49) to "Normal".

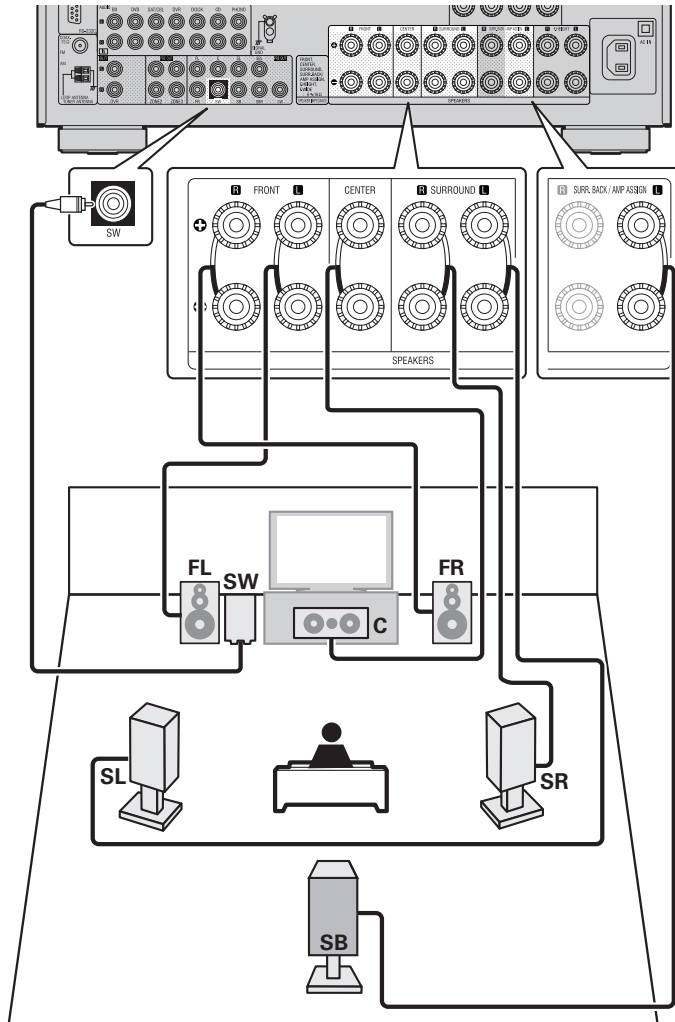

5.1-channel connection

For 5.1-channel playback, set "Set up "Amp Assign"" (page 49) to "Normal".

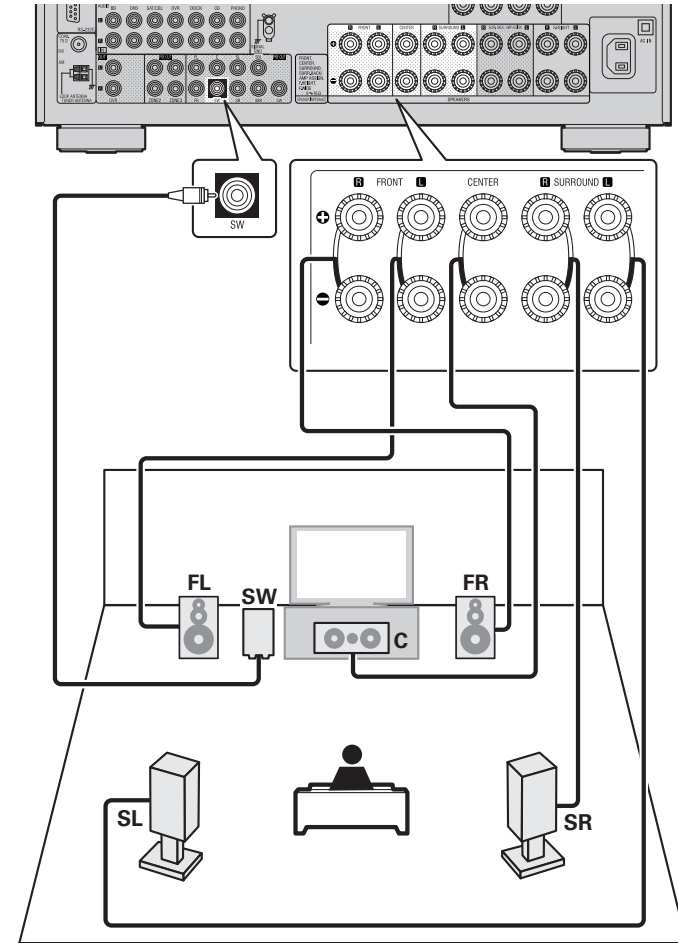

Front A/B connection

The second set of front speakers can be connected to the SURR. BACK/AMP ASSIGN terminals. In this case, set "Set up "Amp Assign"" (page 49) to "Front B".

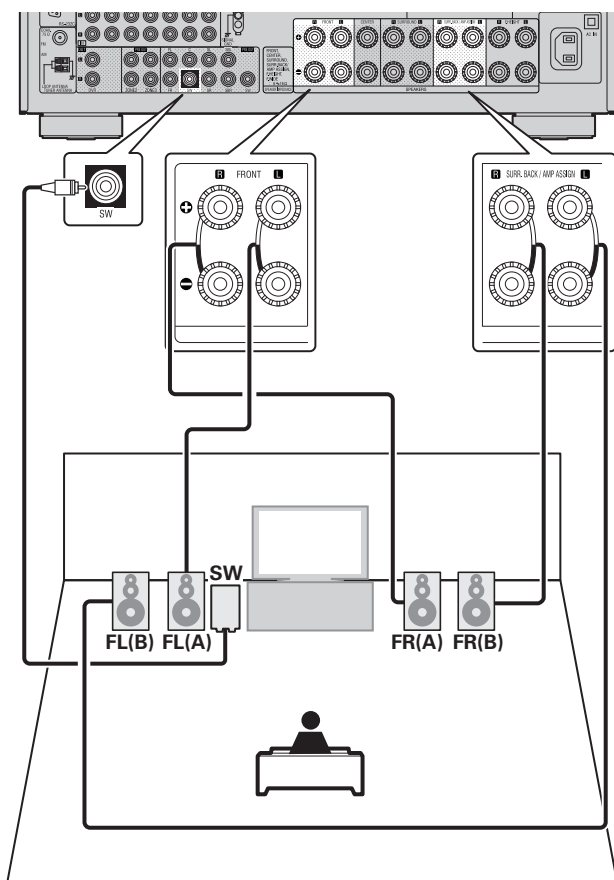

For surround playback of a multichannel source, if you connect the center speaker, surround speakers and subwoofers, 5.1-channel playback is available. Front speakers can be used separately, depending on the speaker's specifications or playback source such as front speakers (A) for multichannel playback and front speakers (B) for 2-channel playback (page 77 "Front Speaker Setup").

2.1-channel connection

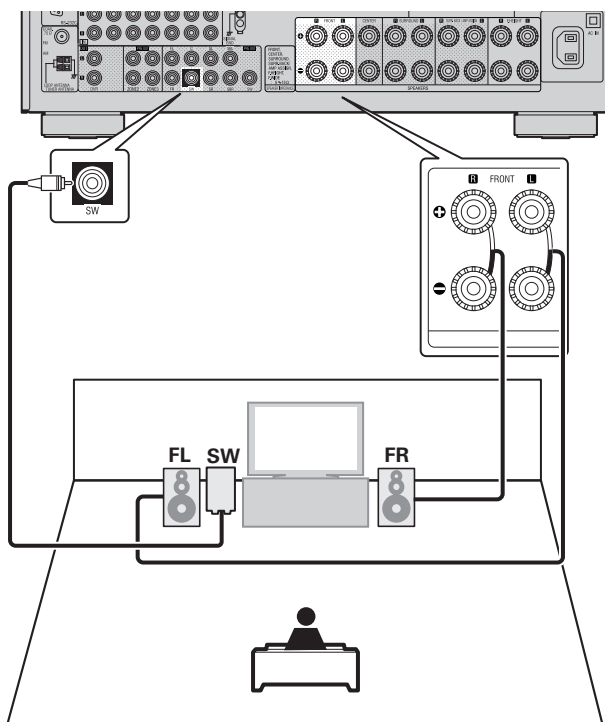

For connecting two subwoofers

Two subwoofers can be connected to this unit. The same signal is output from each subwoofer terminal.

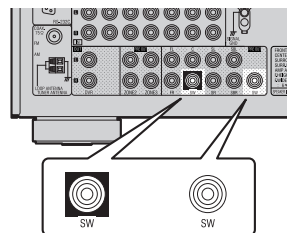

Bi-Amp connection

A bi-amp connection is to connect separate amplifiers to the tweeter terminals and woofer terminals of speakers compatible with the bi-amp function. This prevents the back electromotive force (returned force without output) of the woofer sent to the tweeter, which affects the sound quality of the tweeter, and you can enjoy playback with higher-quality sound. In this case, set "Set up "Amp Assign"" (page 49) to "Bi-Amp".

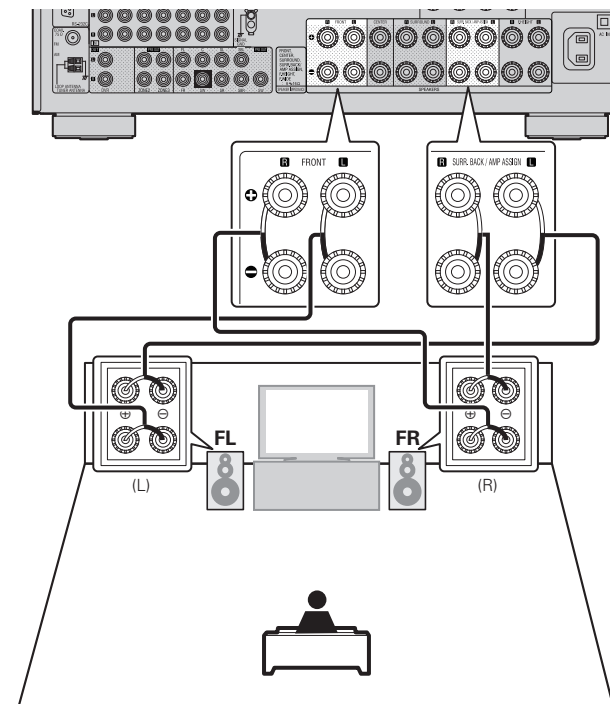

When making a bi-amp connection, the same signal is output from the front speaker terminal and the SURR.BACK/AMP ASSIGN terminal. For surround playback of a multichannel source, if you connect the center speaker, surround speakers and subwoofers, 5.1-channel playback is available.

NOTE

- Use speakers compatible with bi-amp connections.
- When making bi-amp connections, be sure to remove the short-circuiting plate or wire between the speaker's woofer and tweeter terminals.

Connect

5.1-channel + 2.1-channel connection

If front speakers for 2-channel playback are connected to the SURR. BACK/AMP ASSIGN terminals, both speakers for multichannel playback and for 2-channel playback can be used, by switching. In this case, set "Set up "Amp Assign"" (page 49) to "2CH".

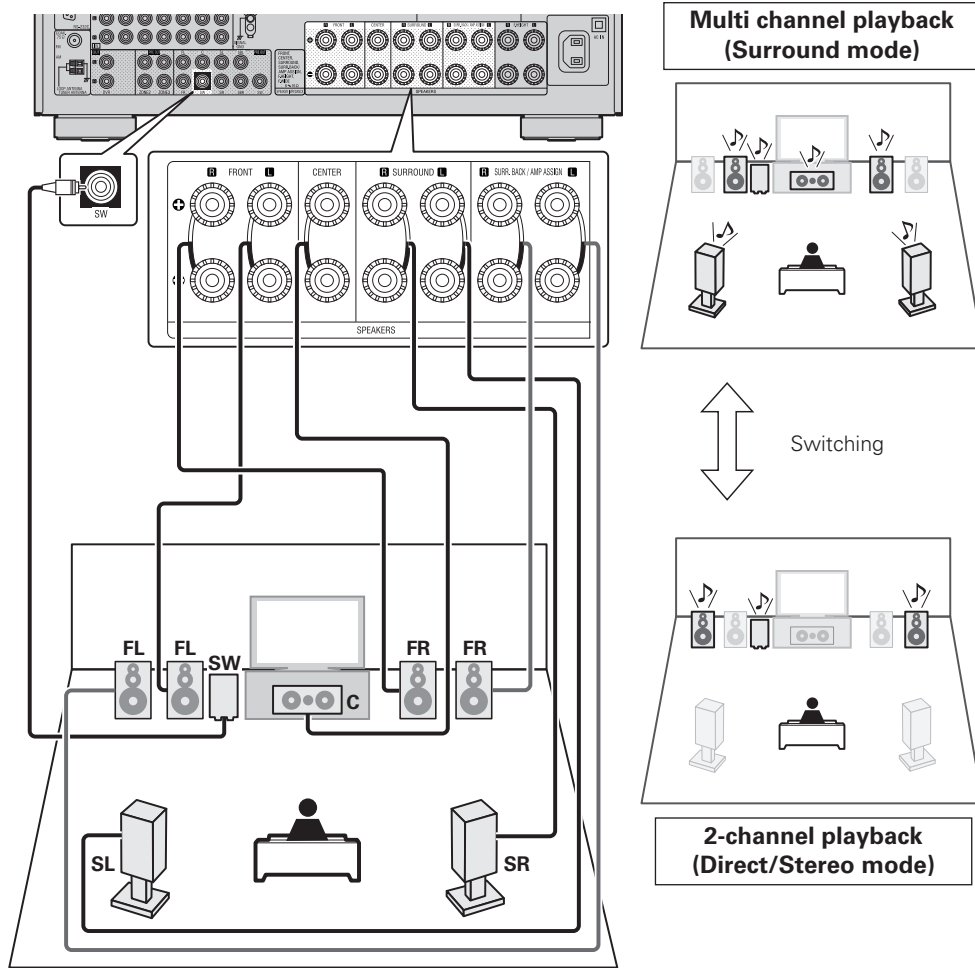

- For switching multichannel playback and 2-channel playback, see "Selecting a listening mode (Surround mode)" (page 40).
- If "2ch Direct/Stereo" – "Setting" (page 78) is set to "Custom", settings for 2-channel playback speakers can be made.

Set up speakers

around items indicate the settings.

This section provides the setup methods of speaker systems other than the 7.1-channel system (with surround back speakers). For the setup methods of the 7.1-channel system with surround back speakers, see "Simple version", "Set up speakers (Audyssey® Auto Setup)" (page 6) of "Simple version".

First install and connect the speakers to this unit.

Before Auto Setup measurement, the settings shown below can be made.

- Changing the amplifier assignment (Amp Assign)
The signal output from the SURR.BACK/AMP ASSIGN speaker terminal of this unit can be switched to match your speaker environment (page 49 "Set up "Amp Assign"").
- Setting the channels to be used (Channel Select)
If channels that are not to be used are set in advance, measurement for the set channels is skipped, and measuring time can be reduced (page 49 "Set up "Channel Select"").

1 Set up the remote control unit

- **Set up the zone mode**
Press **ZONE SELECT** to switch the zone mode to "MAIN".
The "MAIN" indicator lights.

Press ZONE SELECT

- **Set up the operation mode**
Press **AMP** to set the remote control unit to amplifier operation mode.

Press AMP

2 Connect the setup microphone.

When the setup microphone is connected, the following screen is displayed.

AUTO SETUP ▶ AUDYSSEY AUTO SETUP MultEQ XT DENON

STEP1 Preparation
Connect the speakers and place them according to the recommendations in the manual. Set the following items if necessary.
Amp Assign
Channel Select
Auto Setup Start

ENTER Enter RETURN Cancel

Start Auto Setup

3 Set up "Amp Assign"

Use \triangle ∇ to select "Amp Assign", and then press ENTER.

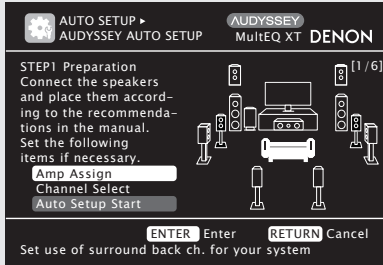

4 Use \triangleleft \triangleright to select the configuration of the connected speakers, and then press RETURN.

Normal Set when using surround back, front height or front wide speakers. In this case, go to step 6.

ZONE2 Set for connecting the speakers for ZONE2 to the SURR. BACK/AMP ASSIGN terminals.

ZONE3 Set for connecting the speakers for ZONE3 to the SURR. BACK/AMP ASSIGN terminals.

ZONE2/3-MONO Set to output the ZONE2 and ZONE3 sound in monaural, and to output the L side of the SURR. BACK/AMP ASSIGN terminal from ZONE2, and the R side from ZONE3.

Bi-Amp Set for connecting a tweeter of a front speaker to the SURR. BACK/AMP ASSIGN terminals and a woofer of the front speaker to the FRONT terminals.

2CH Set for 2-channel direct/stereo playback. When "2CH" is set, connect the second set of front speakers to the SURR.BACK/AMP ASSIGN terminals.

Front B Set for connecting the second set of front speakers to the SURR. BACK/AMP ASSIGN terminals.

5 Set up "Channel Select"

Use \triangle ∇ to select "Channel Select", and then press ENTER.

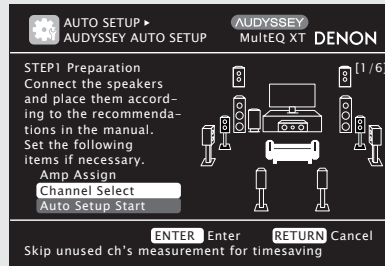

6 Use \triangle ∇ to select a channel.

Front Select for setting the front speakers to be used. In this case, go to step 7.

- "Front" can be set when "Amp Assign" is set to "Front B".

Subwoofer Select for no subwoofers to be used. In this case, go to step 8.

Surround Back Select for no surround back speakers to be used. In this case, go to step 9.

- "Surround Back" can be set when "Amp Assign" is set to "Normal".

Front Height Select for no front height speakers to be used. In this case, go to step 10.

- "Front Height" can be set when "Amp Assign" is set to "Normal".

Front Wide Select for no front wide speakers to be used. In this case, go to step 10.

- "Front Wide" can be set when "Amp Assign" is set to "Normal".

7 [When "Front" is selected in step 6] Press \triangleleft \triangleright to select a front speaker.

A Select this to use front speaker A.

B Select this to use front speaker B.

A+B Select this to use front speakers A and B simultaneously.

8 [When "Subwoofer" is selected in step 6] Use \triangleleft \triangleright to select the item.

Measure Set for measuring a subwoofer.

Skip Set for no measuring of a subwoofer.

9 [When "Surround Back" is selected in step 6] Use \triangleleft \triangleright to select the item.

Measure (2spkr) Set for measuring two surround back speakers.

Measure (1spkr) Set for measuring a surround back speaker.

Skip Set for no measuring of a surround back speaker.

10 [When "F.Height" or "F.Wide" is selected in step 6] Use \triangleleft \triangleright to select the item.

Measure Set to measure the front height speakers or front wide speakers.

Skip Set when you do not want to measure the front height speakers or front wide speakers.

11 Press RETURN.

Proceed to page 8 **STEP1 Preparation** step 6.

NOTE

After performing Audyssey® Auto Setup, do not change the speaker connections or subwoofer volume. In event of a change, perform Audyssey Auto Setup again.



Playback (Advanced operation)

Playback (Basic operation) (👉 page 24)

Selecting a listening mode (Surround mode)
(👉 page 40)

- ❑ HDMI control function (👉 page 50)
- ❑ Sleep timer function (👉 page 51)
- ❑ Adjusting the volume of the speakers (👉 page 51)
- ❑ Quick select function (👉 page 52)
- ❑ REC OUT mode (👉 page 52)
- ❑ Party mode function (👉 page 53)
- ❑ Operating a wireless LAN-compatible mobile terminal to play music and still pictures (👉 page 54)
- ❑ Web control function (👉 page 55)
- ❑ Various memory functions (👉 page 56)

Convenient functions

HDMI control function

When you make an HDMI connection with a TV or player compatible with this unit and HDMI control functions, you can perform the following operations by setting the HDMI control function of each device.

- ❑ **This unit power off can be linked to the TV power off step.**
- ❑ **You can switch audio output devices with a TV operation.**
When you set "Output audio from amp" in the TV audio output setup operation, you can switch the amp power on.
- ❑ **You can adjust this unit volume in the TV volume adjustment operation.**
- ❑ **You can switch this unit input sources through linkage to TV input switching.**
- ❑ **When playing the player, this unit input source switches to the source for that player.**

NOTE

- The HDMI control function only supports the HDMI MONITOR OUT 1 connector. To use the HDMI control function, connect the television to the HDMI MONITOR OUT 1 connector.
- **When "HDMI Control" is set to "ON", it consumes more standby power.**
- The HDMI control function controls operations of a TV that is compatible with the HDMI control function. Make sure that the TV and HDMI are connected when you perform HDMI control.
- Some functions may not operate depending on the connected TV or player. Check the owner's manual of each device for details beforehand.
- When "Power Off Control" on the menu is set to "OFF" (👉 page 78), this unit is not set to standby even if the connected device is in the standby mode.
- When connection changes are implemented, such as adding connections to HDMI devices, linked operations may be initialized. In this case, you will need to reconfigure the settings.
- When "HDMI Control" is set to "ON", it is not possible to assign an HDMI connector to "TV" at "Input Assign" (👉 page 65).

1 Set the HDMI output connector corresponding with the HDMI control function.

Set "HDMI Control" (👉 page 78) to "ON".

2 Turn the power on for all the equipment connected by HDMI cable.

3 Set the HDMI control function for all equipment connected by HDMI cable.

- Please consult the operating instructions for the connected equipment to check the settings.
- Carry out steps 2 and 3 should any of the equipment be unplugged.

4 Switch the television input to the HDMI input connected to this unit.

5 Switch this unit input to the HDMI input source and check if the picture from the player is ok.

6 When you turn the TV's power to standby, check that the power of this unit also goes to standby.



If the HDMI control function does not operate properly, check the following points.

- Is the TV or player compatible with the HDMI control function?
- Is "HDMI Control" (👉 page 78) set to "ON"?
- Is "Power Off Control" (👉 page 78) set to "All" or "Video"?
- Are the HDMI control function settings of all equipment correct?
- Is the television connected to the HDMI MONITOR OUT 1 connector?

NOTE

Should any of the operations below be performed, the interlocking function may be reset, in which case, repeat steps 2 and 3.

- "Input Assign" – "HDMI" (👉 page 65) setting has changed.
- "Monitor Out" (👉 page 77) setting is changed.
- There is a change to the connection between the equipment and the HDMI, or an increase in equipment.

Sleep timer function

The power automatically goes into standby once the set time has elapsed.

This is convenient for playing sources while going to sleep.

Press SLEEP and display the time you want to set.

The **SLEEP** indicator on the display lights.

- The time switches as shown below each time **SLEEP** is pressed.

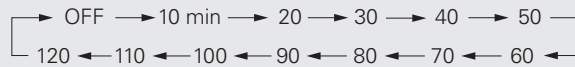

To cancel the sleep timer

Press **SLEEP** to set "OFF".

The **SLEEP** indicator on the display turns off.



- The sleep timer setting is canceled if this unit's power is set to standby or turned off.
- When power to the main zone is turned off with the sleep timer, power in ZONE2 and ZONE3 are also turned off.

Adjusting the volume of the speakers

You can adjust the channel level either according to the playback sources or to suit your taste, as described below.

Adjusting the volume of the different speakers

1 Press **ZONE SELECT** to switch the zone mode to "MAIN".
The "MAIN" indicator lights.

2 Press **AMP** to set the remote control unit to amplifier operation mode.

3 Press **CH LEVEL**.

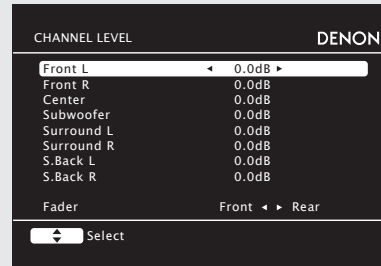

4 Use **Δ**/**∇** to select the speaker.

The speaker that can be set switches each time one of the buttons is pressed.

5 Use **◀**/**▶** to adjust the volume.

- In the case of a subwoofer, pressing **◀** when it is at "–12 dB" will change the setting to "OFF".



When a headphone jack is inserted, the headphone channel level can be adjusted.

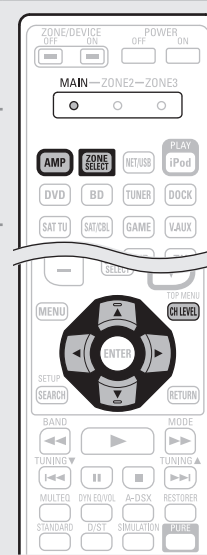

Adjusting the volume of groups of speakers (Fader function)

This function lets you adjust (fade) the sound all at once from the front (front speaker / front height speaker / front wide speaker / center speaker) or rear (surround speaker / surround back speaker).

1 Press **ZONE SELECT** to switch the zone mode to "MAIN".
The "MAIN" indicator lights.

2 Press **AMP** to set the remote control unit to amplifier operation mode.

3 Press **CH LEVEL**.

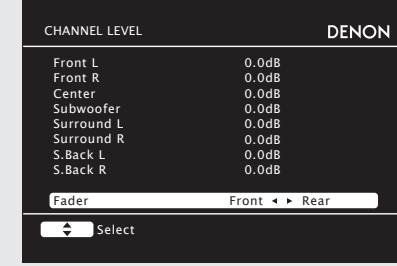

4 Press **∇** to select "Fader", then select the item to be adjusting using **◀**/**▶**.

5 Use **◀**/**▶** to adjust the volume of the speakers.
(**◀**: front, **▶**: rear)



- The fader function does not affect the subwoofer.
- The fader can be adjusted until the volume of the speaker is adjusted to the lowest value of –12 dB.

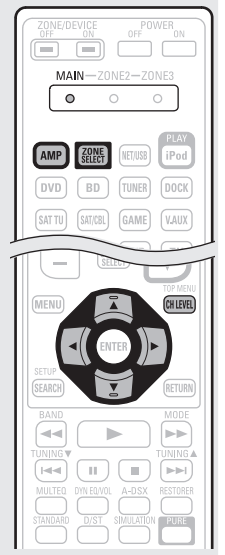

Convenient functions

Quick select function

All of the settings in step 1 can be memorized together. By memorizing frequently used settings, you can quickly access and enjoy a playback environment that is consistently the same.

Saving the settings

1 Set the items below to the settings you want to save.

- ① Input source (page 24)
- ② Volume (page 24)
- ③ Surround mode (page 40)
- ④ Video Select (page 65)
- ⑤ Audyssey Setting (MultEQ® XT, Dynamic EQ®, Dynamic Volume®) (page 71)

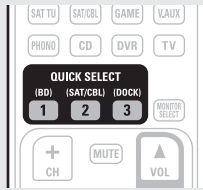

2 Press and hold the desired QUICK SELECT until "Memory" appears on the display. The current settings will be memorized.

[Quick select defaults]

	Input source	Volume
QUICK SELECT 1	BD	-40 dB
QUICK SELECT 2	SAT/CBL	-40 dB
QUICK SELECT 3	DOCK	-40 dB

Recalling the settings

Press **QUICK SELECT** at which the settings you want to call out are saved. The [Q1], [Q2] or [Q3] indicator illuminates on the display.

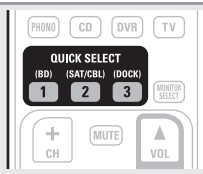

Naming quick select settings

See "Quick Select Name" (page 83).



- The Quick Select function can be set separately for the different zones (page 58 "Quick select function").
- If **QUICK SELECT** on the main unit is pressed, the same function as with the remote control unit can be obtained.

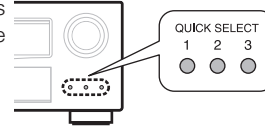

NOTE

Input sources stored with the quick select function cannot be selected if they have been deleted at "Source Delete" (page 82). In this case, store them again.

REC OUT mode

When using the audio/video recording connectors (DVR outputs), you can record the audio or video from a different program source while listening to the currently played track.

1 Press ZONE2/3 / REC SELECT. "ZONE2 Source" is shown on the display.

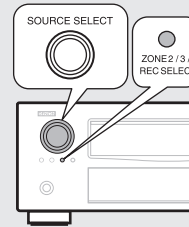

2 Turn SOURCE SELECT until "RECOUT Source" is displayed. The REC indicator illuminates.

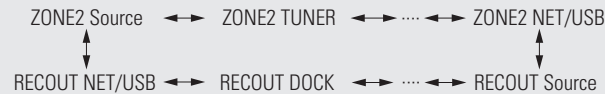

3 Turn SOURCE SELECT to choose the input source to be recorded.

- For operating instructions, refer to the respective equipment's operating instructions.

4 Start recording.

- For operating instructions, refer to the respective equipment's operating instructions.



- To cancel, press **ZONE2/3 / REC SELECT**, then turn **SOURCE SELECT** until "ZONE2 Source" is displayed.
- Make a test recording before starting the actual recording.
- Signals are only output to the analog REC OUT connectors when the digital signals input to the digital input connectors (OPTICAL/COAXIAL) are PCM (2-channel) signals.
- As the digital audio signal input from the HDMI connector is not output to the digital recording connector (OPTICAL), you should connect using the OPTICAL and COAXIAL connectors.
- Sources selected with the REC OUT mode are output from ZONE2 as well.
- The operable buttons on the remote control unit in REC OUT mode while it is in the operating mode for ZONE2 are as follows:
 - ZONE/DEVICE power button
 - Muting button
 - Master volume control button

NOTE

- Recordings you make are for your personal enjoyment and should not be used for other purposes without permission of the copyright holder.
- Input sources for which "Delete" is selected at "Source Delete" (page 82) cannot be selected.

Party mode function

The same network audio (Internet radio, Media server or iPod DIRECT) can be played on multiple DENON products equipped with the Party Mode function and connected in a network.

The party mode consists of one organizer and up to four attendees. When one unit starts the party mode as the organizer, up to four devices on which the party mode function is activated automatically participate in the party as attendees. "Party Mode Function" (page 80) must be set to "ON" ahead of time in order to use the party mode function.

Starting the party mode as the organizer

1 Press **PARTY** to become the organizer.

"Enter Party Mode?" is displayed.

- An error message is displayed when you are not connected to a network.

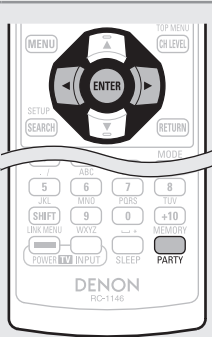

2 Press \triangleleft \triangleright to select "Yes", then press **ENTER**.

The **PARTY ORGANIZER** indicator on the display illuminates. The input source automatically switches to "NET/USB" and the attendees are automatically selected.

3 Play the desired track.

Canceling the party mode

1 While in the party mode, press **PARTY**.

"Exit Party Mode?" is displayed on the menu screen.

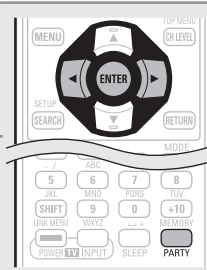

2 Press \triangleleft \triangleright to select "Yes", then press **ENTER**.

"Power off Attendees component?" is displayed.

3 Press \triangleleft \triangleright to select "Yes" or "No", then press **ENTER**.

Yes The power of the attendees is turned off and the party mode is canceled.

No The party mode is canceled without turning off the power of the attendees.

Participating in the party mode as an attendee

- When the organizer starts the party mode, up to four attendees are selected automatically. No operation is required.
- When a device becomes an attendee, **PARTY ATTENDEE** appears on the display. The input source automatically switches to "NET/USB" and the same network audio as on the organizer is played.
- If there are fewer than four attendees, a device can join the party mode after it has started. To participate in the party mode, perform the operation described below.

1 Press **PARTY**.

"Enter Party Mode?" is displayed.

- An error message is displayed when you are not connected to a network.

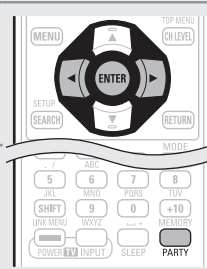

2 Press \triangleleft \triangleright to select "Yes", then press **ENTER**.

Canceling the party mode

1 While in the party mode, press **PARTY**.

"Exit Party Mode?" is displayed on the menu screen.

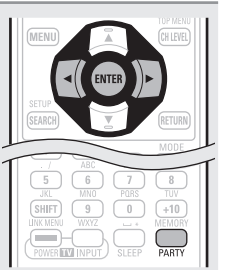

2 Press \triangleleft \triangleright to select "Yes", then press **ENTER**.

In this case, the other devices remain in the party mode.



"Flickr", "Napster" and "USB" are not available in the Party Mode. There can only be one organizer in the network. To form a new party mode, first cancel the current party mode.

Convenient functions

Operating a wireless LAN-compatible mobile terminal to play music and still pictures

- Perform this procedure using a wireless LAN-compatible mobile terminal conforming to the DLNA (Digital Living Network Alliance) standard.
- This function allows you to play content located on a computer (media server) or mobile terminal device connected on a network by operating a mobile terminal device on the same network.
- There are two types of operations on the mobile terminal device.

□ Playing content on a computer (Media server)

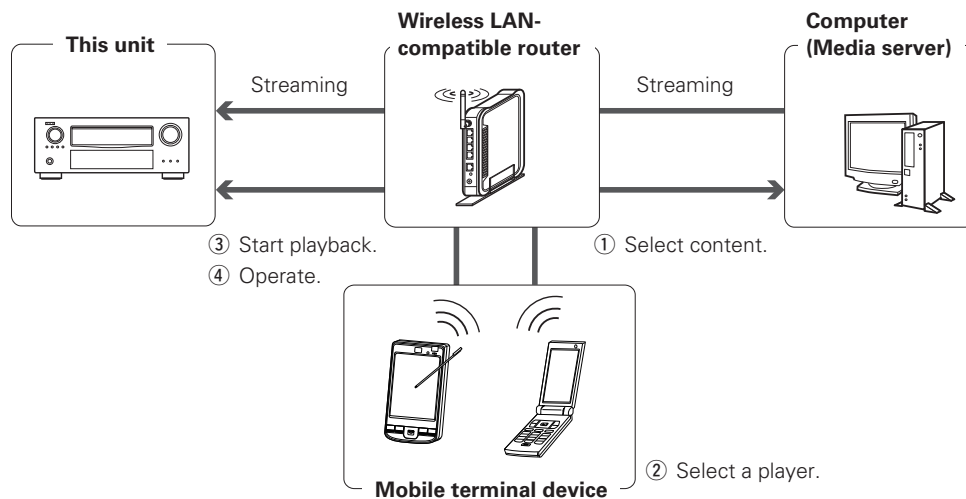

1 From the mobile terminal device, browse the media server on the same network and choose the content you want to play.

2 From the mobile terminal device, select this unit from among the products on the network.

Playback of the content selected in step 1 begins.

- When selecting this unit from the mobile terminal device, the name of this unit is displayed at "Friendly Name" (☞ page 80 "Friendly Name Edit").
- The following operations are possible from the mobile terminal device:
 - File operations (play, stop, pause, track search)
 - Play mode settings (repeat/random)
 - Volume adjustment

□ Playing contents on a mobile terminal device

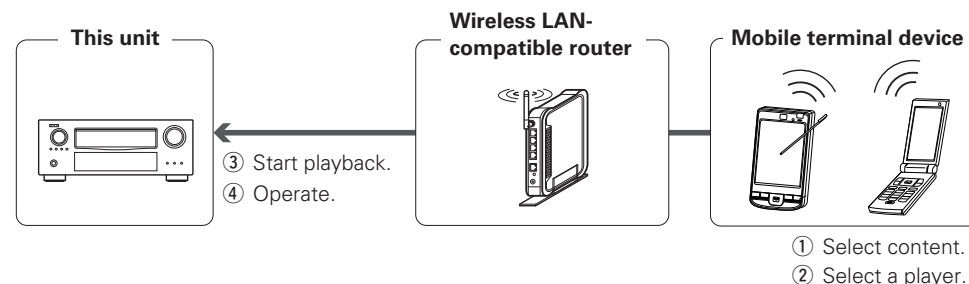

1 Select the content you want to play from among the mobile terminal devices.

2 From the mobile terminal device, select this unit from among the products on the network.

Playback of the content selected in step 1 begins.

- When selecting this unit from the mobile terminal device, the name of this unit is displayed at "Friendly Name" (☞ page 80 "Friendly Name Edit").
- The following operations are possible from the mobile terminal device:
 - File operations (play, stop, pause, track search)
 - Play mode settings (repeat/random)
 - Volume adjustment



-  is displayed on the menu screen while the mobile terminal device is being operated.

- For the various settings and operating procedures, see the operating instructions of the mobile terminal devices being used.
- When selecting this unit from the mobile terminal device, the name of this unit is displayed at "Friendly Name". "Friendly Name" can be edited at "Friendly Name Edit" (☞ page 80) as desired so that it is easily distinguishable from other devices.
- When playback is started from the mobile terminal device, this unit's input source automatically switches to "NET/USB". Also, when the "Network Standby" setting (☞ page 80) is set to "ON", the power automatically turns on.

NOTE

When operations related to browsing or playback (play, stop, pause, track search) are performed on this unit while operating the mobile terminal device, the connection to the network is disconnected. The network connection is also disconnected when the party mode is started.

Web control function

You can operate this unit using a browser.

1 Switch the “Network Standby” setting to “ON”.
(☞ page 80).

2 Check the IP address of this unit with “Network Information” (☞ page 81).

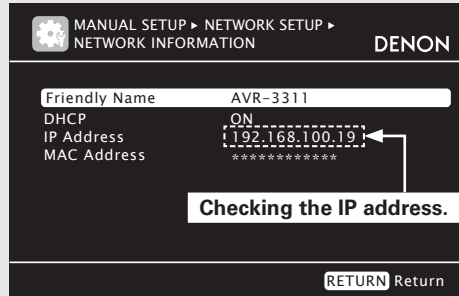

3 Enter the IP address of this unit in browser’s address box.

For example, if the IP address of this unit is “192.168.100.19”, enter “http://192.168.100.19”.

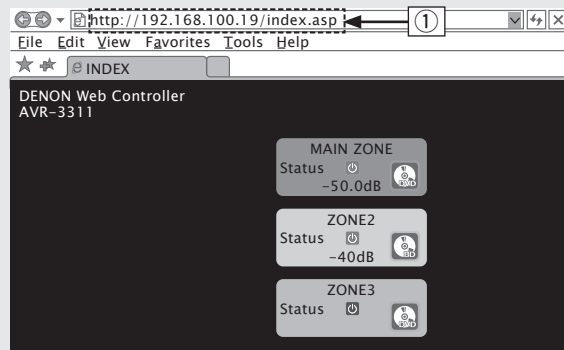

① Entering the IP address.

4 When the top menu is displayed, click on the menu item you want to operate.

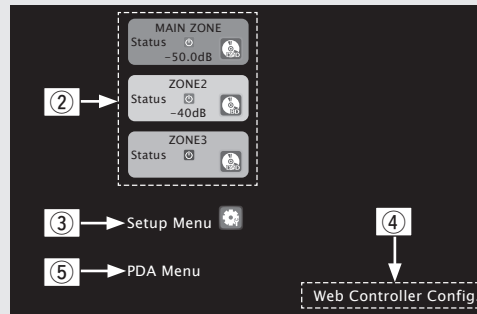

- ② Click when you operate each zone. (☞ [Example 1])
- ③ Click when you operate the setup menu. (☞ [Example 2])
- ④ Click to change the Web control screen setting. (☞ [Example 3])
- ⑤ Click when you operate a small screen such as a PDA screen, etc. (☞ [Example 4])

5 Operate.

[Example 1] Main zone control screen

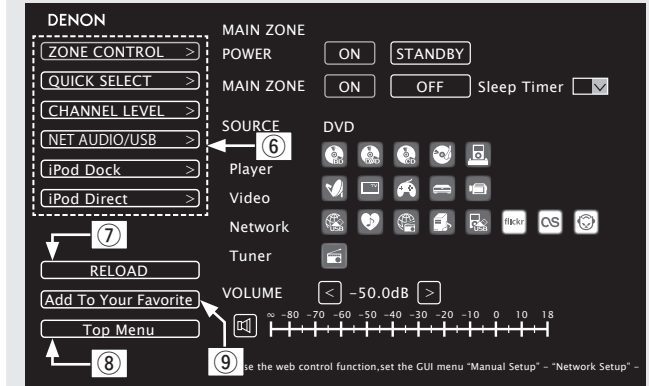

- ⑥ Click to perform individual operations.
Changes to individual operation screens. (☞ [Example 5])
- ⑦ Click when you update to the latest information.
Normally, there is a change to the latest information each time you operate. When operating from the main unit, click this or else the screen will not be updated.
- ⑧ Click to return to the top menu.
Displayed when setting “Top Menu Link Setup” to “ON” in [Example 3]
- ⑨ Click to add a setting to “Favorites” in your browser.
We recommend registering the setting screens for the different zones in the browser’s favorites so as not to accidentally perform menu operations for zones you do not intend to operate.

Convenient functions

[Example 2] Setup menu screen

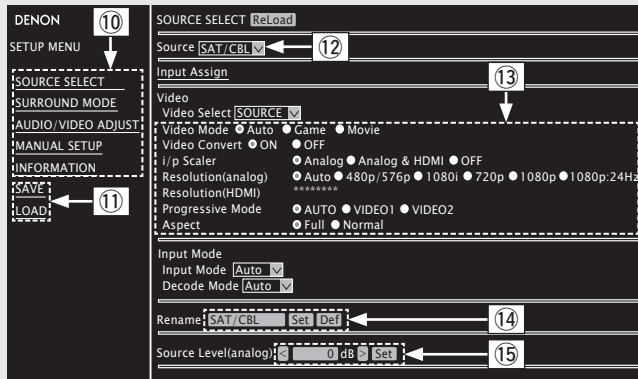

- ⑩ Click the menu item from which you want to make settings. The display on the right becomes the individual setting screens.
- ⑪ Click "SAVE" when you want to save settings, and click "LOAD" when you want to call settings.
- ⑫ Click "v" and select from the displayed items.
- ⑬ Click an item to make a setting.
- ⑭ After entering characters, click "Set" to set, or click "Def" to return to default setting.
- ⑮ Enter figures or click "<" or ">" to make the setting, and then click "Set".

[Example 3] Web configuration screen

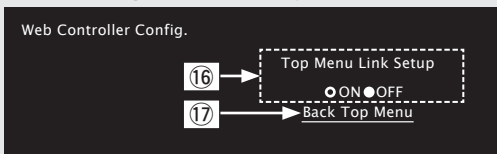

- ⑯ Click "ON" when performing Top Menu Link Setup. When set up, return to the top menu from each operation screen. (Default setting : "OFF")
- ⑰ Click this item to return to the top menu.

[Example 4] PDA menu screen

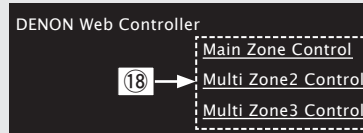

- ⑱ Select this item to operate each zone.

NOTE

You cannot change setup menu operations and zone name on the PDA menu screen.

[Example 5] Net Audio operating screen

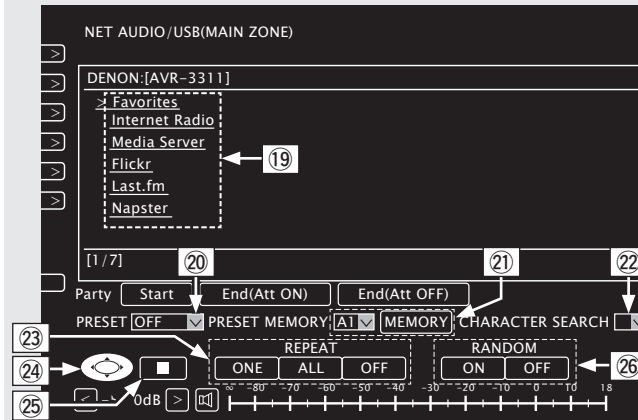

- ⑲ Click the menu items. from which you want to play.
- ⑳ Click "v" to select the preset channel you want to play.
- ㉑ When registering presets, click "v" to select the channel you want to register, and then click "MEMORY".
- ㉒ When searching using an acronym, click "v" and select from the displayed characters.
- ㉓ Click this item to play back repeatedly.
- ㉔ Click this item when selecting menu items.
- ㉕ Click to stop playback.
- ㉖ Click this item to play back randomly.

[Example 6] Dedicated iPod Touch screen

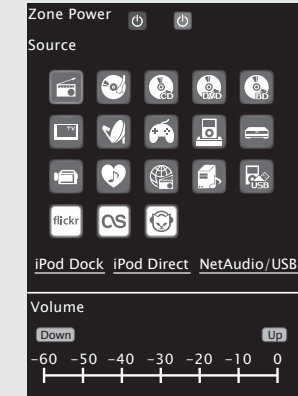

- When accessed from the iPod Touch browser, an optimized operation screen is displayed.

Various memory functions

Personal memory plus function

This function sets the settings (input mode, surround mode, HDMI output mode, MultEQ® XT, Dynamic EQ®, Dynamic Volume®, audio delay etc.) last selected for the individual input sources.



The surround parameters, tone settings and the volumes of the different speakers are stored for the individual surround modes.

Last function memory

This function stores the settings which were made before going into the standby mode. When the power is turned back on, the settings are restored.

Playback in ZONE2/ZONE3 (Separate room)

- You can operate this unit so as to enjoy audio in a room (ZONE2, ZONE3) other than the MAIN ZONE (room where the unit is located).
- You can simultaneously play back the same source in both the MAIN ZONE, ZONE2 and ZONE3. You can also play back separate sources in the MAIN ZONE, ZONE2 and ZONE3.



The source selected for ZONE2 is also output from the recording output connectors.

Audio output

There are two methods to do this, as described below. Choose one of the methods.

- ① Zone playback by speaker output
- ② Zone playback by audio output (PRE OUT)
Use an external amplifier.

① Zone playback by speaker output

The ZONE2 and ZONE3 audio signals are output from this unit's SURR.BACK/AMP ASSIGN speaker terminals using the amplifier assignment function.

□ Connecting and setting the speakers

	"Amp Assign" setting (☞ page 75) and audio signals output	Connecting the speakers
ZONE2	ZONE2 Output signal : Stereo (L / R)	
ZONE3	ZONE3 Output signal : Stereo (L / R)	
ZONE2 and ZONE3	ZONE2/3-MONO Output signal : Monaural	

② Zone playback by audio output (PRE OUT)

□ Audio connections (ZONE2, ZONE3)

The audio signals of this unit's ZONE2 and ZONE3 audio output terminals are output to the ZONE2 and ZONE3 amplifiers and played on these amplifiers.

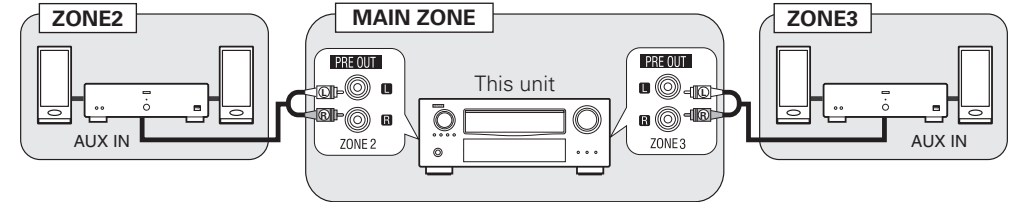

We recommend using high quality pin-plug cables for audio connections in order to prevent noise.

NOTE

- When the input source to which the digital input connectors (OPTICAL/COAXIAL) are assigned is selected in ZONE2 or ZONE3, playback is only possible if the digital signal being input is in PCM (2-channel) format.
- It is not possible to play the digital audio signals input from the HDMI terminals in ZONE2 and ZONE3. Use analog connections for ZONE2 or ZONE3 playback.
- When certain digital signals are being input, noise may be output from the ZONE2 and ZONE3 audio output connectors.
- The menu screen is not output.

Video output

Video Connection

The video signals of this unit's ZONE2 video output terminal are played by the ZONE2 TV.

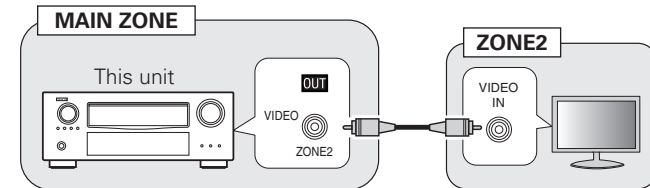

NOTE

It is not possible to output video signals input to the HDMI or component terminals to ZONE2.

Playback

1 Switch ZONE SELECT to "ZONE2" or "ZONE3".

The remote control unit switches to the operating mode for ZONE2 or ZONE3.

2 Press AMP.

3 Press ZONE/DEVICE ON to turn on the ZONE2 or ZONE3 power.

The **Z2** or **Z3** indicator on the display lights.

- Also press input source select button when in standby mode, the power turns on.
- When ZONE/DEVICE OFF is pressed, ZONE2 or ZONE3 turns off.
- Power in ZONE2 or ZONE3 can be turned on or off by pressing ZONE2 ON/OFF or ZONE3 ON/OFF on the main unit.

4 Press the input source select button.

The audio signal of the selected source is output to ZONE2 or ZONE3.

- Turn SOURCE SELECT after pressing ZONE2/3 / REC SELECT on the main unit to select an input source.

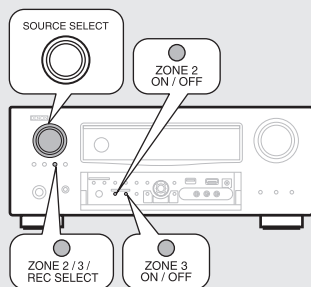

When power for both MAIN ZONE and ZONE2 is set to ON, power of the MAIN ZONE only can be turned off. Select "MAIN" in step 1 then press ZONE/DEVICE OFF.

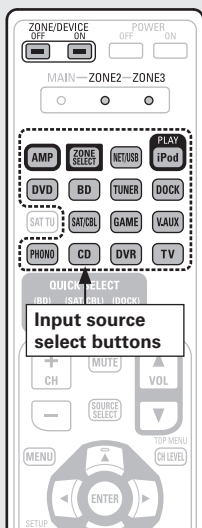

Adjusting the volume

Use VOL ▲▼ to adjust the volume.

[Adjustable range] --- -80dB -- -40dB - 18dB

(When the "Volume Display" (page 82) setting is "Relative")

[Adjustable range] 0 - 41 - 99

(When the "Volume Display" (page 82) setting is "Absolute")

- At time of purchase, "Volume Limit" (page 82) is set to "-10dB (71)".



Turn MASTER VOLUME after pressing ZONE2/3 / REC SELECT on the main unit to adjust the sound volume.

Turning off the sound temporarily

Press MUTE.

The sound is reduced to the level set at "Mute Level" (page 82) in the menu.

- To cancel, either adjust the volume or press MUTE again.
- The setting is canceled when the zone's power is turned off.



You can adjust the tone and volume for ZONE2 and ZONE3 in "Zone Setup" (page 81) in the menu.

Quick select function

It is also possible to save three settings for ZONE2.

□ Saving the settings

1 Set the items below to the settings you want to save.

- ① Input source (page 58)
- ② Volume (page 58)

2 Switch ZONE SELECT to "ZONE2" or "ZONE3".

The remote control unit switches to the operating mode for ZONE2 or ZONE3.

3 In the zone mode for which you want to operate, press and hold the desired QUICK SELECT until "Memory" appears on the display.

The current settings will be memorized.



[Quick select defaults]

	Input source	Volume
Z2/Z3 QUICK SELECT 1	BD	-40dB
Z2/Z3 QUICK SELECT 2	SAT/CBL	-40dB
Z2/Z3 QUICK SELECT 3	DOCK	-40dB

□ Recalling the settings

1 Switch ZONE SELECT to "ZONE2" or "ZONE3".

The remote control unit switches to the operating mode for ZONE2 or ZONE3.

2 Press QUICK SELECT at which the settings you want to call out are saved.

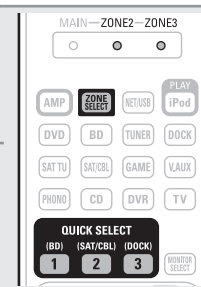

Naming quick select settings

See "Quick Select Name" (page 83).

How to make detailed settings

Menu map

For menu operation, connect a TV to this unit and display the menu on the TV screen. For menu operations, see the following page.

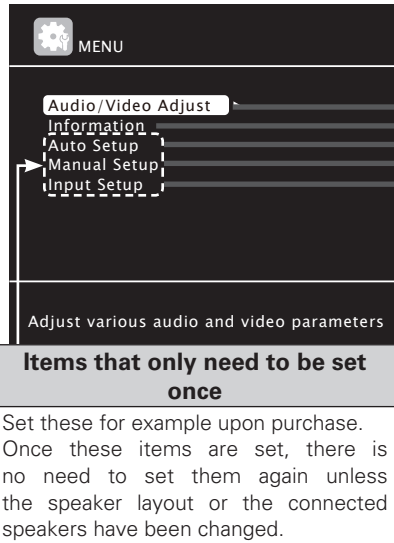

Setting items	Detailed items	Description	Page
1. Audio/Video Adjust AUDIO/VIDEO ADJUST Audio Adjust Picture Adjust	Audio Adjust	Adjusts various audio parameters.	69
	Picture Adjust	Adjusts the picture quality.	74
2. Information INFORMATION Status Audio Input Signal HDMI Information Auto Surround Mode Quick Select Preset Channel	Status	Shows information about current settings.	86
	Audio Input Signal	Shows information about audio input signals.	86
	HDMI Information	Displays the HDMI input/output signals and HDMI monitor information.	86
	Auto Surround Mode	Displays the settings stored for the auto surround mode.	86
	Quick Select	Displays the settings stored for the Quick Select function.	86
3. Auto Setup AUTO SETUP Audyssey Auto Setup Parameter Check	Audyssey Auto Setup	Makes the optimum settings for the speakers being used automatically.	6
	Parameter Check	Checks Audyssey® Auto Setup measurement results. This item is only displayed after Audyssey Auto Setup procedure has been performed.	10
4. Manual Setup MANUAL SETUP Speaker Setup HDMI Setup Audio Setup Network Setup Zone Setup Option Setup	Speaker Setup	Sets the speaker size and distance, the channel level, etc.	75
	HDMI Setup	Makes settings for HDMI video/audio output.	77
	Audio Setup	Makes settings for audio playback.	78
	Network Setup	Makes network settings.	79
	Zone Setup	Makes settings for audio playback in a multi-zone (ZONE2/ZONE3) system.	81
5. Input Setup (Example: TUNER) INPUT SETUP Auto Preset Preset Skip Preset Name Video Rename Source Level 	Option Setup	Makes various other settings.	82
	Auto Preset	Uses the auto preset function to program radio stations.	64
	Preset Skip	Sets the preset memories that you do not want to display when tuning.	64
	Preset Name	Assigns name to a preset memory.	64
	Input Assign	Changes input connector assignment.	64
	Video	Makes the video settings.	65
	Input Mode	Sets the audio input mode and decode mode.	67
	Rename	Changes the display name for this source.	67
	Source Level	Adjusts the playback level of the audio input.	67
	Playback Mode	Makes settings for iPod, USB memory device or network source playback.	67
Still Picture	Makes settings for still picture playback.	68	
<p>Displayed items of the "Input Setup" menu differs, depending on the selected input source.</p>			

Examples of menu and front display

Below we describe typical examples of displays on the TV screen and on the set's display window.

	Menu display	Front display	Description
Top menu display			<ol style="list-style-type: none"> The menu items are displayed here. The selected line is displayed here. The currently selected item is displayed on the display. Use $\Delta \nabla$ to move to the item you want to set.
Display when changing settings			<ol style="list-style-type: none"> Use $\Delta \nabla \triangleleft \triangleright$ to move to the item you want to set. Press ENTER to set to the mode in which the setting can be made. "\triangleleft" and "\triangleright" is displayed at the sides of item whose setting can be changed. Use $\triangleleft \triangleright$ to change to the desired setting.
Display when inputting characters			<ol style="list-style-type: none"> When $\triangleleft \triangleright$ is pressed, the cursor moves to the left or right. When $\Delta \nabla$ is pressed at the position where you want to input the character, the character is input. <p> For inputting characters on a keyboard screen or with the number buttons on the remote control unit, see page 61.</p>
Display when resetting			<ol style="list-style-type: none"> Press ∇ to select "Default", then press ENTER to set. Press \triangleleft to select "Yes", then press ENTER.

Inputting characters

You can change the names as desired using the "Preset Name" (page 64), "Rename" (page 67), "NapsterAccount" (page 81), "Last.fm Account" (page 81), "Zone Rename" (page 83), "Quick Select Name" (page 83) and character input for the network functions.

For inputting characters, there are three methods, as shown below.

Method for inputting characters

Method	Operations
Using the number buttons (Normal screen)	<ul style="list-style-type: none"> Operating with the remote control unit. Multiple characters are assigned to a button, and each time the button is pressed, a character is switched.
Using the cursor buttons (Normal screen)	<ul style="list-style-type: none"> Operating with the remote control unit or the main unit. Use Δ ∇ \triangleleft \triangleright and ENTER to input characters.
Using the keyboard screen	<ul style="list-style-type: none"> Operating with the remote control unit. Select a character on the TV screen to input characters.

Normal screen

Display of a normal input screen

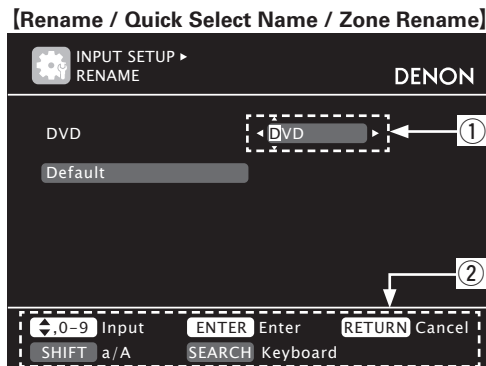

[Account input / Search by text / Proxy Name / Friendly Name Edit]

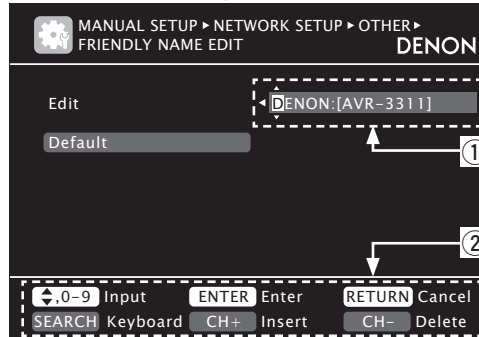

- ① Character input section
- ② Guide for operation buttons

Using the number buttons

1 Display the screen for inputting characters (page 59 "Menu map").

2 Place the cursor at the character to be changed with \triangleleft \triangleright and press the number button (0 – 9) until the desired character is displayed.

The types of characters that can be input are as shown below.

① 1. @ - _ / : ~	⑥ M N O m n o 6
② A B C a b c 2	⑦ P Q R S p q r s 7
③ D E F d e f 3	⑧ T U V t u v 8
④ G H I g h i 4	⑨ W X Y Z w x y z 9
⑤ J K L j k l 5	⑩ 0 (Space) ! " # \$ % & ' () * + , ; < = > ? [\] ^ ` { }

- The input character type can be switched by pressing **SHIFT** while the display name is being changed.
- For entering the characters assigned to one number button continuously, press \triangleright to move the cursor to the right after entering a character then enter the next character.
- For entering characters assigned to separate buttons, press the number button continuously. The cursor automatically moves to the next position, and the entered character is registered.

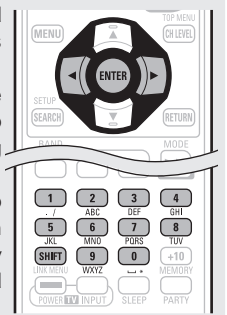

3 Repeat step 2 to change the name then press **ENTER** to register it.

Example: For changing the input source from "DVD" to "DENON"

- ① Place the cursor at "V".
- ② Press **3** twice. "V" changes to "E".
- ③ Press **6** twice. "E" is automatically registered, and "D" changes to "N".
- ④ Press \triangleright . "N" is registered.
- ⑤ Press **6** three times. Input "O".
- ⑥ Press \triangleright . "O" is registered.
- ⑦ Press **6** twice. Input "N".
- ⑧ Press **ENTER** to register the input source name.

Inputting characters

Using the cursor buttons

1 Display the screen for inputting characters (☞ page 59 “Menu map”).

2 Use ◀ ▶ to set the cursor to the character you want to change.

3 Use ▲ ▼ to change the character, then press ENTER.

- The types of characters that can be input are as shown below.

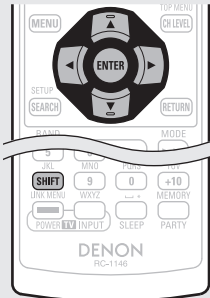

[Upper case characters]

ABCDEFGHIJKLMNOPQRSTUVWXYZ

[Lower case characters]

abcdefghijklmnopqrstuvwxyz

[Symbols] ! " # \$ % & ' () * + , - . / : ; < = > ? @ [\] ^ _ ` { | } ~

[Numbers] 0 1 2 3 4 5 6 7 8 9 (Space)

- The input character type can be switched by pressing **SHIFT** while the display name is being changed.

4 Repeat steps 2 and 3 to change the name then press ENTER to register it.

Keyboard screen

□ Display of a keyboard input screen

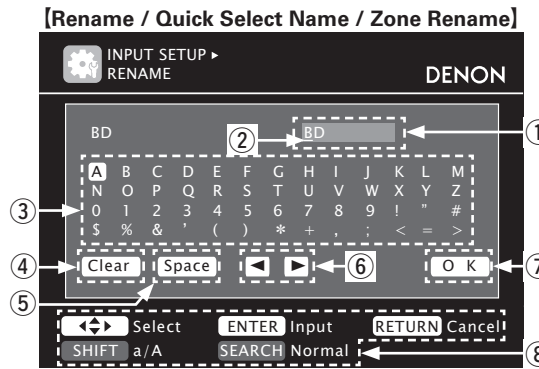

[Account input / Search by text / Proxy Name / Friendly Name Edit]

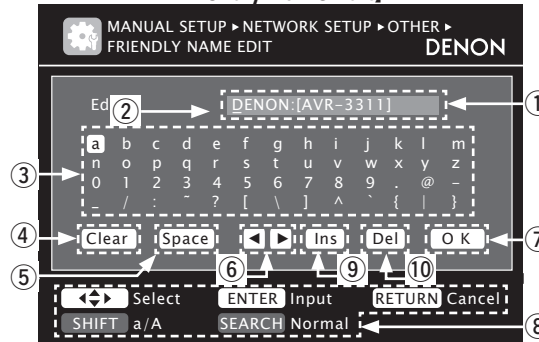

- ① Character input section
- ② Cursor
- ③ Keyboard section
- ④ Clear key
- ⑤ Space key
- ⑥ Cursor keys
- ⑦ OK key
- ⑧ Guide for operation buttons
- ⑨ Insert key
- ⑩ Delete key

1 Display the screen for inputting characters (☞ page 59 “Menu map”).

2 Press **SEARCH** while a normal screen is displayed. A keyboard screen is displayed.

3 Select a character to be changed.
① Press ▲ ▼ ◀ ▶ to select ◀ or ▶.

② Press **ENTER** to place the cursor at the character to be changed.

- Each time **ENTER** is pressed, the cursor moves by one character.



4 Select a character to be input with ▲ ▼ ◀ ▶ then press **ENTER**.

- The types of characters that can be input are as shown below.

[Upper case characters/Numbers/Symbols]

ABCDEFGHIJKLMNOPQRSTUVWXYZ

0123456789

! " # \$ % & ' () * + , ; < = >

[Lower case characters/Numbers/Symbols]

abcdefghijklmnopqrstuvwxyz

0123456789

. @ - _ / : ~ ? [\] ^ ` { | }

- The input character type can be switched by pressing **SHIFT** while the display name is being changed.

5 Repeat steps 3 and 4 to change the name.

6 Use ▲ ▼ ◀ ▶ to select **O K**, then press **ENTER**.

Input Setup

Perform settings related to input source playback.

- You do not have to change the settings to use the unit. Make settings when needed.

Menu operation

1 Press **ZONE SELECT** to switch the zone mode to “MAIN”.
The “MAIN” indicator lights.

2 Press **AMP** to set the remote control unit to amplifier operation mode.

3 Press **MENU**.
The menu is displayed on the TV screen.

4 Use Δ ∇ to select the menu to be set or operated.

5 Press **ENTER** or \triangleright to enter the setting.

- To return to the previous item, press **RETURN**.
- Exiting the Menu, press **MENU** while the menu is displayed.
The menu display disappears.



Important information

□ About the display of input sources

In this section, the configurable input sources for each item are shown as follows.



NOTE

Input sources that have been set to “Delete” at “Source Delete” (page 82) cannot be selected.

Items that can be set with the Input Setup procedure

<p>Auto Preset (page 64)</p>	<p>Preset Skip (page 64)</p>	<p>Preset Name (page 64)</p>
<p>Input Assign (page 64)</p>	<p>Video (page 65)</p>	<p>Input Mode (page 67)</p>
<p>Rename (page 67)</p>	<p>Source Level (page 67)</p>	<p>Playback Mode (page 67): DOCK</p>
<p>Playback Mode (page 68): NET/USB</p>	<p>Still Picture (page 68)</p>	

Simple version

Basic version

Advanced version

Information

Remote control operation buttons



Move the cursor (Up/Down/Left/Right)

ENTER Confirm the setting

RETURN Return to previous menu

Input Setup

Auto Preset

Use the auto preset function to program radio stations.

Setting items	Setting details
Start Start the auto preset process. TUNER	 If an FM station cannot be preset automatically, select the desired station by tuning it in manually, then preset it manually.

Preset Skip

Default settings are underlined.

Set preset channel to be skipped when selecting.

Setting items	Setting details
A – G Set the preset channels you do not want to display. You can set by preset memory block (A to G) or by preset channel (1 to 8). TUNER	1 – 8 : Set by individual preset channels in the currently selected preset memory block. <ul style="list-style-type: none"> • ON : Display the selected preset channel. • Skip : Do not display the selected preset channel.  If you set "Block Presets" to "Skip", you can skip the preset memory blocks (A to G).

Preset Name

Assign name to a preset memory.

Setting items	Setting details
A1 – G8 Select the preset channel. TUNER	<ul style="list-style-type: none"> • Up to eight characters can be input. • For character input, see page 61.
Default The changed preset name is returned to the default setting.	Yes : Reset to the defaults. No : Do not reset to the defaults.

Input Assign

Examples of input assign menu screen displays

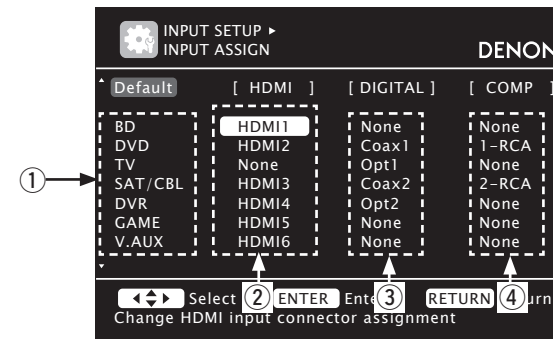

- ① Input Source
- ② HDMI input
- ③ Digital audio input
- ④ Component video input

Input assignments menu operations

- 1 Use $\Delta \nabla \triangleleft \triangleright$ to move the highlight to the item you want to set.
- 2 Press **ENTER**, then use $\triangleleft \triangleright$ to select the input connector to be assigned.
- 3 Press **ENTER** to register the setting.

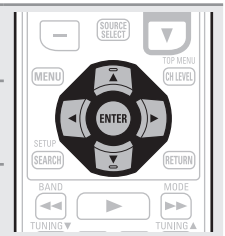



NOTE

If all "HDMI", "Digital" and "Component" assignment of the Game source are set to "None", Game source cannot be selected with the input source selection.



Setting items	Setting details																																		
<p>HDMI Set this to change the HDMI input connectors assigned to the input sources.</p> <table border="1"> <tr> <td>BD</td> <td>DVD</td> <td>TV</td> </tr> <tr> <td>SAT/CBL</td> <td>DVR</td> <td></td> </tr> <tr> <td>GAME</td> <td>V.AUX</td> <td>DOCK</td> </tr> </table>	BD	DVD	TV	SAT/CBL	DVR		GAME	V.AUX	DOCK	<p>HDMI 1 / HDMI 2 / HDMI 3 / HDMI 4 / HDMI 5 / HDMI 6 None : Do not assign an HDMI input connector to the selected input source.</p> <ul style="list-style-type: none"> At time of purchase, the settings of the different input sources are as shown below. <table border="1"> <tr> <th>Input source</th> <td>BD</td> <td>DVD</td> <td>TV</td> <td>SAT/CBL</td> <td>DVR</td> <td>GAME</td> <td>V.AUX</td> <td>DOCK</td> </tr> <tr> <th>Default setting</th> <td>HDMI 1</td> <td>HDMI 2</td> <td>None</td> <td>HDMI 3</td> <td>HDMI 4</td> <td>HDMI 5</td> <td>HDMI 6</td> <td>None</td> </tr> </table> <p></p> <ul style="list-style-type: none"> An input source to which an HDMI input connector cannot be assigned is displayed as “---”. To play the video signal assigned at “HDMI” combined with the audio signal assigned at “Input Assign” – “Digital”, select “Digital” at “Input Mode” (page 67). The audio signals input from the analog and digital connectors are not output to the monitor. When a control dock for iPod is connected, signals cannot be assigned to the HDMI connectors. When “HDMI Control” (page 78) is set to “ON”, HDMI input connector cannot be assigned to “TV”. 	Input source	BD	DVD	TV	SAT/CBL	DVR	GAME	V.AUX	DOCK	Default setting	HDMI 1	HDMI 2	None	HDMI 3	HDMI 4	HDMI 5	HDMI 6	None							
BD	DVD	TV																																	
SAT/CBL	DVR																																		
GAME	V.AUX	DOCK																																	
Input source	BD	DVD	TV	SAT/CBL	DVR	GAME	V.AUX	DOCK																											
Default setting	HDMI 1	HDMI 2	None	HDMI 3	HDMI 4	HDMI 5	HDMI 6	None																											
<p>Digital Set this to change the digital input connectors assigned to the input sources.</p> <table border="1"> <tr> <td>BD</td> <td>DVD</td> <td>TV</td> </tr> <tr> <td>SAT/CBL</td> <td>DVR</td> <td></td> </tr> <tr> <td>GAME</td> <td>V.AUX</td> <td>DOCK</td> </tr> <tr> <td>CD</td> <td></td> <td></td> </tr> </table>	BD	DVD	TV	SAT/CBL	DVR		GAME	V.AUX	DOCK	CD			<p>COAX1 – 2 (COAXIAL) / OPT1 – 2 (OPTICAL) None : Do not assign a digital input connector to the selected input source.</p> <ul style="list-style-type: none"> At time of purchase, the settings of the different input sources are as shown below. <table border="1"> <tr> <th>Input source</th> <td>BD</td> <td>DVD</td> <td>TV</td> <td>SAT/CBL</td> <td>DVR</td> </tr> <tr> <th>Default setting</th> <td>None</td> <td>COAX 1</td> <td>OPT 1</td> <td>COAX 2</td> <td>OPT 2</td> </tr> </table> <table border="1"> <tr> <th>Input source</th> <td>GAME</td> <td>V.AUX</td> <td>DOCK</td> <td>CD</td> </tr> <tr> <th>Default setting</th> <td>None</td> <td>None</td> <td>None</td> <td>None</td> </tr> </table>	Input source	BD	DVD	TV	SAT/CBL	DVR	Default setting	None	COAX 1	OPT 1	COAX 2	OPT 2	Input source	GAME	V.AUX	DOCK	CD	Default setting	None	None	None	None
BD	DVD	TV																																	
SAT/CBL	DVR																																		
GAME	V.AUX	DOCK																																	
CD																																			
Input source	BD	DVD	TV	SAT/CBL	DVR																														
Default setting	None	COAX 1	OPT 1	COAX 2	OPT 2																														
Input source	GAME	V.AUX	DOCK	CD																															
Default setting	None	None	None	None																															

Setting items	Setting details																											
<p>Component Set this to change the component video input connectors assigned to the input sources.</p> <table border="1"> <tr> <td>BD</td> <td>DVD</td> <td>TV</td> </tr> <tr> <td>SAT/CBL</td> <td>DVR</td> <td></td> </tr> <tr> <td>GAME</td> <td>V.AUX</td> <td>DOCK</td> </tr> </table>	BD	DVD	TV	SAT/CBL	DVR		GAME	V.AUX	DOCK	<p>1-RCA / 2-RCA (Component video) None : Do not assign a component video input connector to the selected input source.</p> <ul style="list-style-type: none"> At time of purchase, the settings of the different input sources are as shown below. <table border="1"> <tr> <th>Input source</th> <td>BD</td> <td>DVD</td> <td>TV</td> <td>SAT/CBL</td> <td>DVR</td> <td>GAME</td> <td>V.AUX</td> <td>DOCK</td> </tr> <tr> <th>Default setting</th> <td>None</td> <td>1-RCA</td> <td>None</td> <td>2-RCA</td> <td>None</td> <td>None</td> <td>None</td> <td>None</td> </tr> </table> <p></p> <ul style="list-style-type: none"> An input source to which a component video input connector cannot be assigned is displayed as “---”. When a control dock for iPod is connected, signals cannot be assigned to the component video connectors. 	Input source	BD	DVD	TV	SAT/CBL	DVR	GAME	V.AUX	DOCK	Default setting	None	1-RCA	None	2-RCA	None	None	None	None
BD	DVD	TV																										
SAT/CBL	DVR																											
GAME	V.AUX	DOCK																										
Input source	BD	DVD	TV	SAT/CBL	DVR	GAME	V.AUX	DOCK																				
Default setting	None	1-RCA	None	2-RCA	None	None	None	None																				
<p>Default The “Input Assign” settings are returned to the default settings.</p>	<p>Yes : Reset to the defaults. No : Do not reset to the defaults.</p> <p> If you select “Default” and press ENTER, the message “Default Setting?” is displayed. Select “Yes” or “No”, and then press ENTER.</p>																											

Video



Default settings are underlined.



Set the source video.
* “TV” or “GAME” can be set when “HDMI” (page 65) or “Component” (page 65) has been assigned.

Setting items	Setting details
<p>Video Select Video of another input source is played back combined with the playing audio.</p>	<p>Source : Play the picture and sound of the input source. BD / DVD / TV / SAT/CBL / DVR / GAME / V.AUX / DOCK : Select video input source to view. This can be set for individual input sources.</p> <p> “TV” and “GAME” can be selected only when a component video is assigned as an input source.</p> <p>NOTE</p> <ul style="list-style-type: none"> It is not possible to select HDMI input signals. Input sources for which “Delete” is selected at “Source Delete” (page 82) cannot be selected.



Input Setup

Setting items	Setting details
<p>Video Mode Make settings for video processing.</p> <p>BD DVD TV * SAT/CBL DVR GAME * V.AUX DOCK</p>	<p>Auto : Process video automatically based on the HDMI content information. Movie : Process video normally. Game : Always process video appropriate for game content.</p> <p></p> <ul style="list-style-type: none"> • If "Video Mode" is set to "Auto", the mode is switched according to the input contents. • If a source is played in both MAIN ZONE (audio and video) and ZONE2 (audio only) modes in the same room, audio in MAIN ZONE and ZONE2 modes may sound out of synchronization, but this is not malfunction. In this case, setting to "Game" mode may improve audio synchronization.
<p>Video Convert The input video signal is converted automatically in conjunction with the connected TV (page 13 "Converting input video signals for output (Video conversion function)").</p> <p>BD DVD TV * SAT/CBL DVR GAME * V.AUX DOCK</p>	<p>ON : The input video signal is converted. OFF : The input video signal is not converted.</p> <p></p> <ul style="list-style-type: none"> • When a non-standard video signal from a game machine or some other source is input, the video conversion function might not operate. In this case set "Video Convert" to "OFF". • When "Video Convert" is set to "OFF", the video conversion function does not work. In this case, connect this unit and TV with the same type of cable.
<p>i/p Scaler Convert the input source's resolution to the resolution set at "Resolution".</p> <p>BD DVD TV * SAT/CBL DVR GAME * V.AUX DOCK NET/USB</p>	<p>Analog : Use i/p scaler function for analog video signal. Analog & HDMI : Use i/p scaler function for analog and HDMI video signal. HDMI : Use i/p scaler function for HDMI video signal. OFF : Do not use i/p scaler function.</p> <p></p> <ul style="list-style-type: none"> • "Analog & HDMI" and "HDMI" can be set for input sources for which an HDMI input connector is assigned. • Which items can be set depend on the input source assigned to each input connector. • This function is not effective when the input signal is x.v.Color, 3D, sYCC 601 color, Adobe RGB color, Adobe YCC 601 color or computer resolution.

Setting items	Setting details
<p>Resolution Set the output resolution. Resolution (Analog) : Analog Video Resolution (HDMI) : HDMI</p> <p>BD DVD TV * SAT/CBL DVR GAME * V.AUX DOCK NET/USB</p>	<p>Auto : The number of pixels the TV connected to the HDMI output connector supports is detected automatically and the appropriate output resolution is set. 480p / 576p / 1080i / 720p / 1080p / 1080p:24Hz : Set the output resolution.</p> <p></p> <ul style="list-style-type: none"> • This item can be set when "i/p Scaler" is set to anything other than "OFF". • When "i/p Scaler" is set to "Analog & HDMI", the resolution of both the analog video input signal and HDMI input signal can be set. • To watch 1080p/24Hz pictures, use a TV that supports 1080p/24Hz video signals. • When set to "1080p/24Hz", you can enjoy film-like pictures for film sources (in 24 Hz). For video sources and mixed sources, we recommend setting the resolution to "1080p". • It is not possible to convert a 50 Hz signal into 1080p/24Hz. It is output at a resolution of 1080p/50Hz.
<p>Progressive Mode Set an appropriate progressive conversion mode for the source video signal.</p> <p>BD DVD TV * SAT/CBL DVR GAME * V.AUX DOCK</p>	<p>Auto : The video signal is automatically detected and the appropriate mode is set. Video1 : Select mode suitable for video playback Video2 : Select mode suitable for video and 30-frame film material playback.</p> <p></p> <p>This item can be set when "i/p Scaler" is set to anything other than "OFF".</p>
<p>Aspect Set the aspect ratio for the video signals output to the HDMI.</p> <p>BD DVD TV * SAT/CBL DVR GAME * V.AUX DOCK NET/USB</p>	<p>Full : Output at 16:9 aspect ratio. Normal : Output at 4:3 aspect ratio.</p> <p></p> <p>"Aspect" can be set when "i/p Scaler" is set to anything other than "OFF".</p>



* "TV" or "GAME" can be set when "HDMI" (page 65) or "Component" (page 65) has been assigned.



Input Mode

Default settings are underlined.

The input modes available for selection may vary depending on the input source.

Setting items	Setting details
Input Mode Set the audio input modes for the different input sources.	<p>Auto : Automatically detect input signal and perform playback.</p> <p>HDMI : Play only signals from HDMI input.</p> <p>Digital : Play only signals from digital input.</p> <p>Analog : Play only signals from analog input.</p> <p></p> <ul style="list-style-type: none"> • "HDMI" can be set for input sources for which "HDMI" is assigned at "Input Assign" (page 65). • "Digital" can be set for input sources for which "Digital" is assigned at "Input Assign" (page 65). • If the input source is set to "TV" or "Game", it cannot be set to "Analog". • When digital signals are properly input, the DIG indicator lights on the display. If the DIG indicator does not light, check the digital input connector assignment and the connections. • If "HDMI Control" is set to "ON" and a TV compatible with the ARC is connected via the HDMI MONITOR connectors, the input mode whose input source is "TV" is fixed to ARC.
Decode Mode Set the decode mode for input source.	<p>Auto : Detect type of digital input signal and decode and play automatically.</p> <p>PCM : Decode and play only PCM input signals.</p> <p>DTS : Decode and play only DTS input signals.</p> <p></p> <ul style="list-style-type: none"> • This item can be set for input sources for which "HDMI" or "Digital" is assigned at "Input Assign" (page 64). • Normally set this mode to "Auto". Set "PCM" and "DTS" when inputting the corresponding input signal.

BD	DVD	TV
SAT/CBL	DVR	
DOCK	GAME	V.AUX
CD		

Rename

Change the display name of the selected input source.

Setting items	Setting details
Rename Change the display name of the selected input source.	<ul style="list-style-type: none"> • Up to eight characters can be input. • For character input, see page 61.
Default The input source name is returned to the default setting.	<p>Yes : Reset to the defaults.</p> <p>No : Do not reset to the defaults.</p>

Source Level

Default settings are underlined.

- This function corrects the playback level of the selected input source's audio input.
- Make this setting if there are differences in the input volume levels between the different sources.

Setting details
<p>-12dB - +12dB (0dB)</p> <p> The analog input level and digital input level can be adjusted independently for input sources for which "HDMI" or "Digital" is assigned at "Input Assign" (page 64).</p>

Playback Mode

Input source : "DOCK"

Setting items	Setting details
Repeat Make settings for repeat mode.	<p>All : All files are played repeatedly.</p> <p>One : A file being played is played repeatedly.</p> <p>OFF : Repeat playback mode is canceled.</p>
<input type="checkbox"/> DOCK	
Shuffle Make settings for shuffle mode.	<p>Songs : Shuffle songs.</p> <p>Albums : Shuffle albums.</p> <p>OFF : Shuffle playback mode is canceled.</p>
<input type="checkbox"/> DOCK	



Input Setup

Input source : "NET/USB"

Setting items	Setting details
Repeat Make settings for repeat mode. NET/USB	All : All files are played repeatedly. One : A file being played is played repeatedly. OFF : Repeat playback mode is canceled.
Random Make random mode settings. NET/USB	ON : Enable random playback. OFF : Disable random playback.
Direct Play Use DIRECT PLAY on the sub remote control unit to set the folder to be played. NET/USB	Favorites : Play songs registered as "Favorites". Music : Play the songs saved on the PC media.

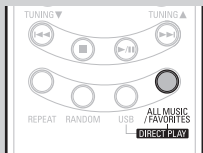

Audio/Video Adjust

The sound being played in the surround mode can be adjusted to your liking. The items (parameters) that can be adjusted depend on the signal being input and the currently set surround mode. For details on the adjustable parameters, see "Surround modes and parameters" (page 101).

Menu operation

- 1 Press **ZONE SELECT** to switch the zone mode to "MAIN".
The "MAIN" indicator lights.
- 2 Press **AMP** to set the remote control unit to amplifier operation mode.
- 3 Press **MENU**.
The menu is displayed on the TV screen.
- 4 Use Δ ∇ to select the menu to be set or operated.
- 5 Press **ENTER** or \triangleright to enter the setting.
 - To return to the previous item, press **RETURN**.
 - Exiting the Menu, press **MENU** while the menu is displayed. The menu display disappears.



Still Picture

Default settings are underlined.

Make settings for playing back still picture images.

Setting items	Setting details
Slide Show Make slide show settings. NET/USB	ON : Display still picture images in a slide show. OFF : Display only the selected still picture image.
Interval Set the playback time per image. NET/USB	<u>5sec</u> – <u>60sec</u>

Items that can be set with the Audio/Video Adjust procedure

- Audio Adjust** (page 69)
- Surround Parameter** (page 69)
 - Tone** (page 70)
 - Audyssey Settings** (page 71)
 - A-DSX Soundstage** (page 72)
 - Manual EQ** (page 73)
 - RESTORER** (page 73)
 - Audio Delay** (page 73)

Picture Adjust (page 74)



Move the cursor (Up/Down/Left/Right)



ENTER Confirm the setting





RETURN Return to previous menu

Audio Adjust

Surround Parameter

Default settings are underlined.

Adjust surround sound parameters. It may not be possible to set this item depending on the input signal.

Setting items	Setting details
Mode Set the play modes for the different surround modes.	<input type="checkbox"/> In the PLIIx or PLII mode Cinema : Surround sound mode optimized for movie sources. Music : Surround sound mode optimized for music sources. Game : Surround sound mode optimized for games. Pro Logic : Dolby Pro Logic playback mode (PLII mode only). <input type="checkbox"/> In the PLIIz mode Height : Dolby PLIIz Height playback mode. <input type="checkbox"/> In the DTS NEO:6 mode Cinema : Surround sound mode optimized for movie sources. Music : Surround sound mode optimized for music sources.  <ul style="list-style-type: none"> • When "Surround Parameter" – "F.Height" (page 69) is set to "ON", the "Height" mode is set automatically. • The "Music" mode is also effective for movie sources including a lot of stereo music.
Cinema EQ Soften the treble range of movie soundtracks for better understanding.	ON : "Cinema EQ" is used. OFF : "Cinema EQ" is not used.
DRC Compress dynamic range (difference between loud and soft sounds).	Auto : Automatic dynamic range compression on/off control according to source. This can be set in the Dolby TrueHD mode. Low / Mid / High : These set the compression level. OFF : Dynamic range compression always off.
D.Comp Compress dynamic range (difference between loud and soft sounds).	Low / Mid / High : These set the compression level. OFF : Turn dynamic range compression off.
LFE Adjust the low-frequency effects level (LFE).	-10dB – 0dB  For proper playback of the different sources, we recommend setting to the values below. <ul style="list-style-type: none"> • Dolby Digital sources : "0dB" • DTS movie sources : "0dB" • DTS music sources : "-10dB"
C.Image Assign center channel signal to front left and right channels for wider sound.	0.0 – 1.0 (0.3)

Setting items	Setting details
Panorama Assign front L/R signal also to surround channels for wider sound.	ON : Set. OFF : Do not set.
Dimension Shift sound image center to front or rear to adjust playback balance.	0 – 6 (3)
C.Width Assign center channel signal to front left and right channels for wider sound.	0 – 7 (3)
Delay Time Adjust delay time to control sound stage size.	0ms – 300ms (30ms)
Effect Lev. Adjust effect signal level.	1 – 15 (10)  Set to a lower level if the positioning and sense of phase of the surround signals seems unnatural.
Room Size Determine size of acoustic environment.	Small : Simulate acoustics of a small room. Medium-S : Simulate acoustics of a medium-small room. Medium : Simulate acoustics of a medium room. Medium-L : Simulate acoustics of a medium-large room. Large : Simulate acoustics of a large room. NOTE "Room Size" does not indicate the size of the room in which sources are played.
F.Height Determine whether to use front height channel.	ON : Audio is output from the front height speaker. OFF : Audio is not output from the front height speaker. NOTE <ul style="list-style-type: none"> • "F.Height" is displayed with the settings listed below. • When "Amp Assign" (page 75) is set to "Normal". • When the "Speaker Config." – "F.Height" setting (page 75) is set to other than "None". • "F.Height" cannot be set if the HD Audio source being played includes a front height channel. In this case, the Front height channel is played back without decoding in PLIIz mode, using the input signal.

Simple version

Basic version

Advanced version

Information

Remote control operation buttons



Move the cursor (Up/Down/Left/Right)

ENTER Confirm the setting

RETURN Return to previous menu

Audio/Video Adjust

Setting items	Setting details
<p>Height Gain Control the front height channel volume.</p>	<p>Low : Reduce the front height channel volume. Mid : Front height channel sound is output with standard sound volume. High : Increase the front height channel volume.</p> <p>NOTE "Height Gain" is displayed for the following settings. • When "Amp Assign" (🔧 page 75) is set to "Normal". • When the "Speaker Config." – "F.Height" setting (🔧 page 75) is set other than to "None". • When surround mode is "PLIIz" or the PLIIz decoder is used.</p>
<p>AFDM (Auto flag detect mode) Detect the source's surround back channel signal and set the optimum surround mode automatically.</p>	<p>ON : Set. OFF : Do not set.</p> <p>[Example] Playing Dolby Digital software (with EX flag) • When "AFDM" is set to "ON", the surround mode is automatically set to the DOLBY D + PLIIx C mode. • To play in the DOLBY DIGITAL EX mode, set "AFDM" to "OFF" and "Surround Parameter" – "S.Back" to "MTRX ON".</p> <p>🔧 Some Dolby Digital EX sources do not include EX flags. If the playback mode does not switch automatically even when "AFDM" is set to "ON", set "Surround Parameter" – "S.Back" to "MTRX ON" or "PLIIx C".</p>
<p>S.Back Sets the method of generating of the surround back channel.</p>	<p><input type="checkbox"/> For 2-channel sources ON : The surround back channel is used. OFF : No signal is played from the surround back channels.</p> <p><input type="checkbox"/> For multi-channel sources Set the decoding method for the surround back channel. DSCRT ON : Play the surround back signals included in the 7.1-channel source. MTRX ON : Generate and play the surround back signals from the surround channel signals. ES MTRX*1 : Generate and play the surround back signals from the surround channel signals of the DTS source. ES DSCRT*2 : Play the surround back signals included in the 6.1-channel DTS source. PLIIx C*3 : Generate and play the surround back signals by decoding the signals in the Dolby Pro Logic IIx Cinema mode. PLIIx M : Generate and play the surround back signals by decoding the signals in the Dolby Pro Logic IIx Music mode. OFF : Do not play the surround back channel.</p> <p>*1 This can be selected when playing DTS sources. *2 This can be selected when playing DTS sources including a signal to identify discrete 6.1-channel signals. *3 This can be selected when "Speaker Config." – "S.Back" (🔧 page 75) is set to "2spkr".</p>

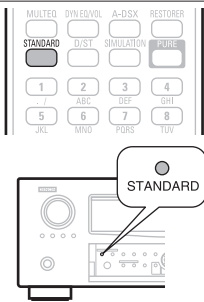
Setting items	Setting details
<p>S.Back (Continued)</p>	<p>🔧 This can also be set by pressing STANDARD. • If the source being played contains a surround back signal, the decoder type is automatically selected by the AFDM function. Set "AFDM" to "OFF" to switch to your preferred decoder.</p> <p>NOTE If the setting in "Speaker Config." – "S.Back" (🔧 page 75) is "None", "S.Back" is not displayed.</p> 
<p>Speaker Make settings for the speakers outputting sound when playing back in DENON original surround mode.</p>	<p>S.Back : Sound is output from the surround back speakers. F.Wide : Sound is output from the front wide speakers. F.Height : Sound is output from the front height speakers. OFF : Sound is not output from the surround back speakers, front wide speakers, and front height speakers.</p> <p>NOTE Only speakers that are set to something other than "None" in "Speaker Config." (🔧 page 75) can be selected.</p>
<p>Subwoofer Turn subwoofer output on and off.</p>	<p>ON : The subwoofer is used. OFF : The subwoofer is not used.</p> <p>NOTE This can be set when the surround mode is "DIRECT" (🔧 page 42), "PURE DIRECT" (🔧 page 42) and the "Subwoofer Mode" (🔧 page 76) is "LFE+Main".</p>
<p>Default The "Surround Parameter" settings are returned to the default settings.</p>	<p>Yes : Reset to the defaults. No : Do not reset to the defaults.</p>
<p><input type="checkbox"/> Tone Adjust the tonal quality of the sound.</p>	<p>Setting items</p> <p>Tone Control Set the tone control function to ON and OFF.</p> <p>Setting details ON : Allow tone adjustment (bass, treble). OFF : Playback without tone adjustment.</p> <p>🔧 "Tone Control" can be set when "Dynamic EQ" (🔧 page 71) is set to "OFF".</p> <p>NOTE • "Tone Control" settings are not reflected to ZONE2 and ZONE3. • The tone cannot be adjusted in the direct mode.</p>



Setting items	Setting details
Bass Adjust low frequency range (bass).	-6dB - +6dB ✎ "Bass" can be set when "Tone Control" is set to "ON".
Treble Adjust high frequency range (treble).	-6dB - +6dB ✎ "Treble" can be set when "Tone Control" is set to "ON".



Audyssey Settings

Default settings are underlined.

Set MultEQ[®] XT, Dynamic EQ[®] and Dynamic Volume[®]. These can be selected after Audyssey[®] Auto Setup has been performed. For additional information on Audyssey technology, please see page 106.

NOTE

If you have not performed Auto Setup, or if you change the speaker settings after performing Auto Setup, you may not be able to select Dynamic EQ/Dynamic Volume, and "Run Audyssey" may be displayed. In this case, either perform Audyssey Auto Setup over again or perform "Restore" (page 10) to return to the settings after Audyssey Auto Setup was run.

Setting items	Setting details
MultEQ XT Select one equalizer from three modes. MultEQ XT corrects both time and frequency response problems in the listening area based on Audyssey Auto Setup calibration. We recommend "Audyssey". MultEQ XT is the prerequisite function for Dynamic EQ and Dynamic Volume.	<p>Audyssey : Optimize the frequency response of all speakers. Audyssey Byp.L/R : Optimize frequency response of speakers except front L and R speakers. Audyssey Flat : Optimize frequency response of all speakers to flat response. Manual : Apply frequency response set with "Manual EQ" (page 73). OFF : Turn "MultEQ XT" equalizer off.</p> <p>✎</p> <ul style="list-style-type: none"> "Audyssey", "Audyssey Byp. L/R" and "Audyssey Flat" can be selected after Audyssey Auto Setup has been performed. "Audyssey" is automatically selected after performing Audyssey Auto Setup. When "Audyssey", "Audyssey Byp. L/R" or "Audyssey Flat" is selected,  illuminates. After running Audyssey Auto Setup, if the Speaker Configuration, Distance, Channel Level, and Crossover Frequency have changed without increasing the number of speakers measured, only  illuminates. Pressing MULTEQ makes this setting. <p>NOTE</p> <ul style="list-style-type: none"> "MultEQ XT" and "Manual" cannot be selected when "EQ Customize" is set to "Not Used" (page 79). When using headphones, "MultEQ XT" is automatically set to "OFF".



Setting items	Setting details
Dynamic EQ[®] Solve the problem of deteriorating sound quality as volume is decreased by taking into account human perception and room acoustics. Works with MultEQ XT.	<p>ON : Use Dynamic EQ. OFF : Do not use Dynamic EQ.</p> <p>✎</p> <ul style="list-style-type: none">  is displayed when set to "ON". Buttons on the remote control unit or main unit can be used for operations. Press DYN EQ/VOL. <p>Each time DYN EQ/VOL is pressed, the setting is changed as shown below.</p> <p>Dynamic EQ : ON → Dynamic EQ : ON Dynamic Volume : Midnight → Dynamic Volume : Evening</p> <p>Dynamic EQ : OFF ← Dynamic EQ : ON ← Dynamic EQ : ON Dynamic Volume : OFF ← Dynamic Volume : OFF ← Dynamic Volume : Day</p> <p>Reference Level Offset Audyssey Dynamic EQ is referenced to the standard film mix level. It makes adjustments to maintain the reference response and surround envelopment when the volume is turned down from 0 dB. However, film reference level is not always used in music or other non-film content. Dynamic EQ Reference Level Offset provides three offsets from the film level reference (5 dB, 10 dB, and 15 dB) that can be selected when the mix level of the content is not within the standard.</p> <p>0dB (Film Ref) : This is the default setting and should be used when listening to movies. 5dB : Select this setting for content that has a very wide dynamic range, such as classical music. 10dB : Select this setting for jazz or other music that has a wider dynamic range. This setting should also be selected for TV content as that is usually mixed at 10 dB below film reference. 15dB : Select this setting for pop/rock music or other program material that is mixed at very high listening levels and has a compressed dynamic range.</p> <p>✎ Setting is enabled when "Dynamic EQ" is "ON" (page 71).</p>

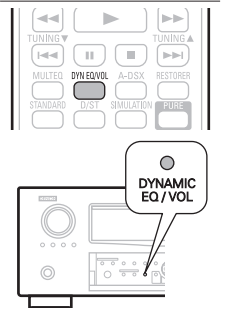

Simple version

Basic version

Advanced version

Information

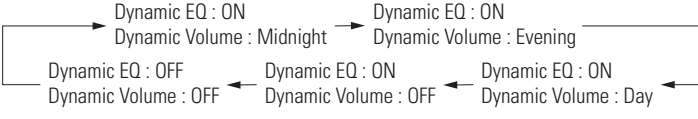

Audio/Video Adjust

Setting items	Setting details
<p>Dynamic Volume® Solve the problem of large variations in volume level between TV, movies and other content (between quiet passages and loud passages, etc.) by automatically adjusting to the user's preferred volume setting.</p>	<p>Midnight : Most adjustment to softest and loudest sounds. Evening : Medium adjustment to loudest and softest sound. Day : Least adjustment to loudest and softest sounds. OFF : Do not use the "Dynamic Volume".</p> <p> is displayed when set to "ON".</p> <ul style="list-style-type: none"> If "Dynamic Volume" is set to "Yes" in Auto Setup (page 9), the setting is automatically changed to "Evening". Buttons on the remote control unit or main unit can be used for operations. Press DYN EQ/VOL. <p>Each time DYN EQ/VOL is pressed, the setting is changed as shown below.</p> 

A-DSX Soundstage

Default settings are underlined.

Adjust Audyssey DSX™ setting and sound stage parameters.

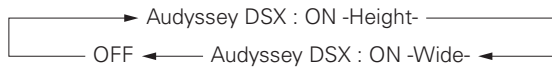
Setting items	Setting details
<p>Audyssey DSX Provides more immersive surround sound by adding the new channels.</p>	<p>ON-Height- : Turn on A-DSX processing for height expansion. ON-Wide- : Turn on A-DSX processing for wide expansion. OFF : Do not set Audyssey DSX.</p> <p> This can also be set by pressing A-DSX on the remote control unit or press AUDYSSEY DSX on the main unit. • The  indicator illuminates on the display.</p> 
<p>Stage Width Adjust sound stage width when using front wide speakers.</p>	<p>-10 - +10 (0)</p>
<p>Stage Height Adjust sound stage height when using front height speakers.</p>	<p>-10 - +10 (0)</p> <ul style="list-style-type: none"> "Audyssey DSX" can be set when you are using front height speakers or front wide speakers. "Audyssey DSX" is only valid when using a center speaker. "Audyssey DSX" is valid when surround mode is STANDARD mode other than PLIIz Height. "A-DSX Soundstage" cannot be configured if the HD Audio source being played includes Front height and Front wide channels. In this case, the respective channels are played back using the input signals.
<p>About Audyssey Dynamic Surround Expansion (A-DSX)</p> <p>Audyssey DSX is a scalable surround expansion system that adds new channels to improve the surround impression. Based on research in human hearing Audyssey DSX adds a pair of Wide channels in the front because that information is critical in the rendering of a realistic soundstage. Audyssey DSX then adds a pair of Height channels above the main front channels to reproduce the next most important acoustical and perceptual cues related to soundstage depth. In addition to creating these new channels, Audyssey DSX applies Surround Envelopment Processing to enhance the blend between the front and side/back surround channels. The result is a much more seamless and enveloping home theater experience.</p>	



Manual EQ

Default settings are underlined.

Use the graphic equalizer to adjust the tone of each speaker.
 "Manual EQ" can be set when "MultEQ XT" setting (page 71) is "Manual"

Setting items	Setting details
Adjust CH Correct the tone of each speaker.	① Select the speaker tone adjustment method. All : Adjust the tone of all speakers together. L/R : Adjust the tone of left and right speakers together. Each : Adjust the tone of each speaker. ② Select the speaker. ③ Select the adjustment frequency band. 63Hz / 125Hz / 250Hz / 500Hz / 1kHz / 2kHz / 4kHz / 8kHz / 16kHz • Select the speakers you want to adjust when "L/R" or "Each" is selected. ④ Adjust the level. -20.0dB - +6.0dB (0.0dB)
Base Curve Copy Copy "Audyssey Flat" curve from MultEQ [®] XT.	Yes : Copy. No : Do not copy. • "Base Curve Copy" is displayed after Audyssey [®] Auto Setup has been performed.
Default The "Manual EQ" settings are returned to the default settings.	Yes : Reset to the defaults. No : Do not reset to the defaults.

RESTORER

Compressed audio formats such as MP3, WMA (Windows Media Audio) and MPEG-4 AAC reduce the amount of data by eliminating signal components that are hard for the human ear to hear. The RESTORER function generates the signals eliminated upon compression, restoring the sound to conditions near those of the original sound before compression. It also corrects the sense of volume of the bass to obtain richer sound with compressed audio signals.

Setting details

OFF : Do not use RESTORER.

Mode1 (RESTORER 64) : Optimized mode for compressed sources with very weak highs.

Mode2 (RESTORER 96) : Apply suitable bass and treble boost for all compressed sources.

Mode3 (RESTORER HQ) : Optimized mode for compressed sources with normal highs.



- This item can be set with analog signals or when a PCM signal (fs = 44.1/48 kHz) is input.
- This cannot be set when the surround mode is set to "DIRECT" or "PURE DIRECT".
- This item default setting for "iPod" and "NET/USB" is "Mode3". All others are set to "OFF".
- When set to something other than "OFF", **RSTR** is displayed.
- Pressing **RESTORER** on the remote control unit or the main unit makes this setting.

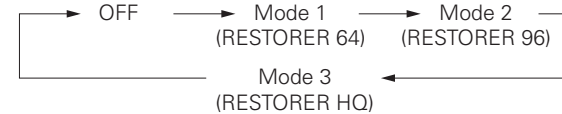

Audio Delay

Default settings are underlined.

While viewing video, manually adjust the time to delay audio output.

Setting details

0ms - 200ms



- This item can be set within the range of 0 to 100 ms when "Auto Lip Sync" is set to "ON" and when a TV compatible with Auto Lip Sync is connected.
- Store "Audio Delay" for each input source.
- Audio Delay for game mode can be set when "Video Mode" (page 66) is set to "Auto" or "Game".



Audio/Video Adjust

Picture Adjust

Default settings are underlined.

- This item can be set when the input source is **BD** **DVD** **TV** **SAT/CBL** **DVR** **GAME** **V.AUX** **DOCK** **NET/USB**.
- With input sources other than the ones above, this item can be set when “Video Select” is selected. In this case, the original input source settings are called out.
- Can be set when the “Video Convert” setting (page 66) is “ON”.
- “TV” or “GAME” can be set when “HDMI” (page 65) or “Component” (page 65) has been assigned.

Setting items	Setting details
Contrast Adjust picture contrast.	-6 - <u>+6 (0)</u>
Brightness Adjust picture brightness.	<u>0</u> - +12
Chroma Level Adjust picture chroma level (saturation).	-6 - <u>+6 (0)</u>
Hue Adjust color hue.	-6 - <u>+6 (0)</u>
DNR Reduce overall picture noise.	<u>OFF</u> / Low / Mid / High
Enhancer Emphasize picture contours.	<u>0</u> - +12



- “DNR” and “Enhancer” are each effective with HDMI output.
- The value set at “Picture Adjust” is stored in the memory individually for each input source.

Manual Setup

Set when changing Audyssey® Auto Setup settings, or when changing the audio, video, display or other settings.

- If you change the speaker settings after performing Audyssey Auto Setup, it will not be possible to set MultEQ® XT, Dynamic EQ® and Dynamic Volume® (page 71, 72).
- Can be used without changing the settings. Please set if necessary.

Menu operation

1 Press **ZONE SELECT** to switch the zone mode to “MAIN”.
The “MAIN” indicator lights.

2 Press **AMP** to set the remote control unit to amplifier operation mode.

3 Press **MENU**.
The menu is displayed on the TV screen.

4 Press **Δ**/**∇** to select the menu to be set or operated.

5 Press **ENTER** or **▷** to enter the setting.

- To return to the previous item, press **RETURN**.
- Exiting the Menu, press **MENU** while the menu is displayed.
The menu display disappears.



Items that can be set with the Manual Setup procedure

<p>Speaker Setup (page 75)</p>	<p>HDMI Setup (page 77)</p>	<p>Audio Setup (page 78)</p>
<p>Network Setup (page 79)</p>	<p>Zone Setup (page 81)</p>	<p>Option Setup (page 82)</p>



Move the cursor (Up/Down/Left/Right)



Confirm the setting



Return to previous menu

Speaker Setup

Default settings are underlined.

- Perform when setting the speakers manually or when changing settings made in Audyssey Auto Setup.
- If you change the speaker settings after performing Audyssey Auto Setup, it will not be possible to select MultEQ XT, Dynamic EQ and Dynamic Volume (page 71, 72).
 - Manual Setup can be used without changing the settings. Please set if necessary.

Setting items	Setting details
Amp Assign Set the speakers connected to this unit.	<p>Normal : Set when using surround back, front height or front wide speakers.</p> <p>ZONE2 : Set for connecting the speakers for ZONE2 to the SURR.BACK/AMP ASSIGN terminals.</p> <p>ZONE3 : Set for connecting the speakers for ZONE3 to the SURR.BACK/AMP ASSIGN terminals.</p> <p>ZONE2/3-MONO : Set to output the ZONE2 and ZONE3 sound in monaural, and to output the L side of the SURR.BACK/AMP ASSIGN terminal from ZONE2, and the R side from ZONE3.</p> <p>Bi-Amp : Set for connecting a tweeter of a front speaker to the SURR.BACK/AMP ASSIGN terminals and a woofer of a front speaker to the FRONT terminals.</p> <p>2CH : Set for 2-channel direct/stereo playback. When "2CH" is set, connect the second set of front speakers to the SURR.BACK/AMP ASSIGN terminals.</p> <p>Front B : Set for connecting the second front speakers to the SURR.BACK/AMP ASSIGN terminals. In this case, make settings for "Front Speaker Setup" (page 77).</p>
Speaker Config. Select speaker configuration and size (bass reproduction capability).	<p>Front : Set the front speaker size.</p> <ul style="list-style-type: none"> • Large : Use a large speaker that can adequately play back low frequencies. • Small : Use a small speaker that has inadequate playback capacity for low frequencies. <p>• When "Subwoofer" is set to "No", "Front" is automatically set to "Large".</p> <p>• When "Front" is set to "Small", "Center", "Surround", "S.Back", "F.Height" and "F.Wide" can not be set to "Large".</p> <p>Center : Set the presence and size of the center speaker.</p> <ul style="list-style-type: none"> • Large : Use a large speaker that can adequately play back low frequencies. • Small : Use a small speaker that has inadequate playback capacity for low frequencies. • None : Select when a center speaker is not connected. <p>• "Large" is not displayed when "Front" is set to "Small".</p>

NOTE

Do not use the outward shape of the speaker to determine selection of a "Large" or "Small" speaker. Instead, use the frequencies set in "Crossover Frequency" (page 77) as the standard for determining bass reproduction capability.

Simple version

Basic version

Advanced version

Information

Setting items	Setting details
Speaker Config. (Continued)	<p>Subwoofer : Set the presence of a subwoofer.</p> <ul style="list-style-type: none"> • Yes : Use a subwoofer. • No : Select when a subwoofer is not connected. <p>• When "Front" is set to "Small", "Subwoofer" is automatically set to "Yes".</p> <p>Surround : Set the presence and size of the surround speakers.</p> <ul style="list-style-type: none"> • Large : Use a large speaker that can adequately play back low frequencies. • Small : Use a small speaker that has inadequate playback capacity for low frequencies. • None : Select when the surround speakers are not connected. <p>• When "Surround" is set to "Large", "S.Back", "F.Height" and "F.Wide" can be set to "Large".</p> <p>• When "Surround" is set to "None", "S.Back", "F.Height" and "F.Wide" can automatically set to "None".</p> <p>S.Back : Set the presence, size and number of surround back speakers.</p> <ul style="list-style-type: none"> • Large : Use a large speaker that can adequately play back low frequencies. • Small : Use a small speaker that has inadequate playback capacity for low frequencies. • None : Select when the surround back speakers are not connected. <ul style="list-style-type: none"> • 2spkrs : Use two surround back speakers. • 1spkr : Use only one surround back speaker. When you select this setting, connect the surround back speaker to the left (L) channel. <p>• Even when the "S.Back" setting is other than "None", sound may not be emitted from the surround back speaker, depending on the playback source. In this case, make "Surround Parameter" – "S.Back" setting other than "OFF" (page 70).</p> <p>NOTE</p> <p>When "Amp Assign" setting (page 75) is other than "Normal", you cannot make the "S.Back" setting.</p> <p>F.Height : Set the presence and size of the front height speakers.</p> <ul style="list-style-type: none"> • Large : Use a large speaker that can adequately play back low frequencies. • Small : Use a small speaker that has inadequate playback capacity for low frequencies. • None : Select when the front height speakers are not connected. <p>NOTE</p> <p>When "Amp Assign" setting (page 75) is other than "Normal", you cannot make the "F.Height" setting.</p>

Remote control operation buttons



Move the cursor (Up/Down/Left/Right)



Confirm the setting







Return to previous menu

Manual Setup

Setting items	Setting details
Speaker Config. (Continued)	<p>F.Wide : Set the presence and size of the front wide speakers.</p> <ul style="list-style-type: none"> • Large : Use a large speaker that can adequately play back low frequencies. • Small : Use a small speaker that has inadequate playback capacity for low frequencies. • None : Select when the front wide speakers are not connected. <p>NOTE</p> <p>When “Amp Assign” setting (🔧 page 75) is other than “Normal”, you cannot make the “F.Wide” setting.</p>
Bass Setting Set subwoofer and LFE signal range playback.	<p>Subwoofer Mode : Select low range signals to be reproduced by subwoofer.</p> <ul style="list-style-type: none"> • LFE : The low range signal of the channel set to “Small” speaker size is added to the LFE signal output from the subwoofer. • LFE+Main : The low range signal of all channels is added to the LFE signal output from the subwoofer. <p>🔧</p> <ul style="list-style-type: none"> • “Subwoofer Mode” can be set when “Speaker Config.” – “Subwoofer” (🔧 page 75) is set to “Yes”. • Play music or a movie source and select the mode offering the strongest bass. • Select “LFE+Main” if you want the bass signals to always be produced from the subwoofer. <p>NOTE</p> <p>If “Front” and “Center” for “Speaker Config.” are set to “Large”, and “Subwoofer Mode” is set to “LFE”, no sound may be output from the subwoofers, depending on the input signal or selected surround mode.</p> <p>LPF for LFE : Set LFE signal playback range.</p> <p>• 80Hz / 90Hz / 100Hz / 110Hz / 120Hz / 150Hz / 200Hz / 250Hz</p>
Distance Set distance from listening position to speakers. Measure beforehand the distance from the listening position to each speaker.	<p>Unit : Set the unit of distance.</p> <ul style="list-style-type: none"> • Meters / Feet <p>Step : Set the minimum variable width of the distance.</p> <ul style="list-style-type: none"> • 0.1m / 0.01m • 1ft / 0.1ft <p>Front L / Front R / Center / Subwoofer / Surround L / Surround R / S.Back L* / S.Back R* / F.Height L / F.Height R / F.Wide L / F.Wide R : Select the speaker.</p> <p>* When the “Speaker Config.” – “S.Back” setting (🔧 page 75) is set to “1spkr”, “S.Back” is displayed.</p> <p>• 0.00m – 18.00m / 0.0ft – 60.0ft : Set the distance.</p>

Setting items	Setting details
Distance (Continued)	<p>🔧</p> <ul style="list-style-type: none"> • The speakers that can be selected differ depending on the “Amp Assign” (🔧 page 75) and “Speaker Config.” (🔧 page 75) settings. • Default settings : Front L / Front R / Center / Subwoofer / F.Height L / F.Height R / F.Wide L / F.Wide R : 3.6 m (12.0 ft) Surround L / Surround R / S.Back L / S.Back R : 3.0 m (10.0 ft) • Set the difference in the distance between the speakers to less than 6.0 m (20 ft). <p>NOTE</p> <p>Speakers set to “None” in “Speaker Config.” (🔧 page 75) are not displayed.</p> <p>Default : The “Distance” settings are returned to the default settings.</p> <ul style="list-style-type: none"> • Yes : Reset to the defaults. • No : Do not reset to the defaults. <p>🔧 When you select “Default” and press ENTER, the “Default Setting?” prompt is displayed. Select either “Yes” or “No”, and press ENTER.</p>
Channel Level Set the volume of the test tone to be the same when it is output from each speaker.	<p>Test Tone Start : Output test tone.</p> <ul style="list-style-type: none"> • Front L / F.Height L / Center / F.Height R / Front R / F.Wide R / Surround R / S.Back R* / S.Back L* / Surround L / F.Wide L / Subwoofer : Select the speaker. * When the “Speaker Config.” – “S.Back” setting (🔧 page 75) is set to “1spkr”, “S.Back” is displayed. <ul style="list-style-type: none"> • -12.0dB – +12.0dB (0.0dB) : Adjust the volume. <p>🔧</p> <ul style="list-style-type: none"> • When ◀ is pressed while the subwoofer volume is set to “-12 dB”, the “Subwoofer” setting switches to “OFF”. • When “Channel Level” is adjusted, the adjusted values are set for all the surround modes. To adjust the channel level separately for the different surround modes, use the operation see page 51. <p>NOTE</p> <ul style="list-style-type: none"> • Speakers set to “None” in the “Speaker Config.” (🔧 page 75) settings are not displayed. • When a headphones jack is inserted in the PHONES jack of this unit, the “Channel Level” is not displayed. <p>Default : The “Channel Level” settings are returned to the default settings.</p> <ul style="list-style-type: none"> • Yes : Reset to the defaults. • No : Do not reset to the defaults. <p>🔧 When you select “Default” and press ENTER, the “Default Setting?” prompt is displayed. Select either “Yes” or “No”, and press ENTER.</p>









Setting items	Setting details
<p>Crossover Frequency Set the maximum frequency of the bass signal output from each channel to the subwoofer. Set the Crossover Frequency to suit the bass reproduction capability of the speaker being used.</p>	<p>Crossover : Set the crossover frequency. • 40Hz / 60Hz / <u>80Hz</u> / 90Hz / 100Hz / 110Hz / 120Hz / 150Hz / 200Hz / 250Hz</p> <p>Advanced : Specify crossover frequency for each speaker. • Front / Center / Surround / S.Back / F.Height / F.Wide : Select the speaker. • 40Hz / 60Hz / <u>80Hz</u> / 90Hz / 100Hz / 110Hz / 120Hz / 150Hz / 200Hz / 250Hz : Set the crossover frequency.</p> <p> “Crossover Frequency” can be set when the “Bass Setting” – “Subwoofer Mode” ( page 76) setting is “LFE+Main”, or when you have a speaker that is set to “Small”.</p> <ul style="list-style-type: none"> Always set the crossover frequency to “80Hz”. When using small speakers, however, we recommend setting the crossover frequency to a higher frequency. For speakers set to “Small”, sound below the crossover frequency is cut from the sound output. The cut bass sound is output from the subwoofer or front speakers. The speakers that can be set when “Advanced” is selected differ depending on to the “Subwoofer Mode” setting ( page 76). <ul style="list-style-type: none"> When “LFE” is selected, speakers set to “Small” at “Speaker Config.” can be set. If the speakers are set to “Large”, “Full Band” is displayed and the setting cannot be made. If set to “LFE+Main”, this setting can be made regardless of the speaker size.
<p>Front Speaker Setup Set the front speakers to use for every surround mode.</p> <p>NOTE This can be set when “Amp Assign” is set to “Front B” ( page 75).</p>	<p>2CH DIRECT/STEREO : The front speakers used in the direct, stereo and pure direct play modes (2 channel) are set in advance. • A : Front speaker A is used. • B : Front speaker B is used. • A+B : Both front speakers A and B are used.</p> <p>MULTI CH : The front speakers used in modes other than the direct, stereo and pure direct play modes (2 channel) are set in advance. • A : Front speaker A is used. • B : Front speaker B is used. • A+B : Both front speakers A and B are used.</p>

HDMI Setup

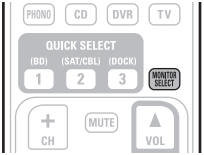

Default settings are underlined.

Make settings for HDMI video/audio output.

Setting items	Setting details
<p>RGB Range Set the video range of RGB output from the HDMI connector.</p>	<p>Normal : Output with RGB video range (16 (black) to 235 (white)). Enhanced : Output with RGB video range (0 (black) to 255 (white)).</p> <p> This setting is active when using a TV equipped with a DVI terminal.</p>
<p>Auto Lip Sync Make automatic compensation for timing shift in audio and video output.</p>	<p>ON : Compensated. OFF : Not compensated.</p>
<p>HDMI Audio Out Select HDMI audio output device.</p>	<p>AMP : Play back through speakers connected to the receiver. TV : Play back through TV connected to the receiver.</p> <p> When the HDMI control function is activated, priority is given to the TV audio setting ( page 50 “HDMI control function”).</p>
<p>Monitor Out Make settings for HDMI monitor output.</p>	<p>Monitor 1 : A TV connected to the MONITOR 1 terminal is always used. Monitor 2 : A TV connected to the MONITOR 2 terminal is always used.</p> <p> With “Resolution” ( page 66) not set to “Auto”, check whether the TV you are using is compatible with the resolution under “HDMI Information” – “HDMI Monitor 1 Information” and “HDMI Monitor 2 Information” ( page 86).</p> <p>You can also set “Monitor Out” by pressing MONITOR SELECT.</p> 







Manual Setup

Setting items	Setting details
<p>HDMI Control You can link operations with devices connected to HDMI and compatible with HDMI Control.</p>	<p>ON : Use HDMI control function. OFF : Do not use HDMI control function.</p> <p> • When a device that is not compatible with the HDMI control function is connected, set "HDMI Control" to "OFF".</p> <p>• Please consult the operating instructions for each connected component to check the settings.</p> <p>• Refer to "HDMI control function" (page 50) for more information about the HDMI control function.</p> <p>NOTE</p> <p>• When "HDMI Control" is set to "ON", it consumes more standby power. If you are not using this unit for an extended period, it is recommended that you unplug the power cord from the power outlet.</p> <p>• "HDMI Control" does not work when the power to the equipment is off. Either turn power on or set to standby.</p> <p>• The HDMI control function controls operations of a TV that is compatible with the HDMI control function. Make sure that the TV and HDMI are connected when you perform HDMI control.</p> <p>• If the "HDMI Control" settings have been changed, always reset the power to connected devices after the change.</p>
<p>Standby Source Sets the HDMI input source to put into standby when the power is on.</p>	<p>Last : This item is set at the last-used input source. HDMI1 / HDMI2 / HDMI3 / HDMI4 / HDMI5 / HDMI6 : Put the respective input source into standby.</p> <p> "Standby Source" can be set when "HDMI Control" is set to "ON".</p>
<p>Power Off Control Links the power standby of this unit to external equipment.</p>	<p>All : If power to a connected TV is turned off independently of the input source, power to this unit is automatically set to standby.</p> <p>Video : If power to a connected TV is turned off when the input source is BD / DVD / TV / SAT/CBL / DVR / GAME / V.AUX / DOCK, power to this unit is automatically set to standby.</p> <p>OFF : This unit does not link with power to a TV.</p> <p> "Power Off Control" can be set when "HDMI Control" is set to "ON".</p>







Audio Setup

Default settings are underlined.

Make settings for audio playback.

Setting items	Setting details
<p>2ch Direct/Stereo Select the method for setting the speakers used in the 2-channel direct and stereo playback modes.</p>	<p>Setting : Select the method for setting the speakers used in the 2-channel direct and stereo playback modes.</p> <ul style="list-style-type: none"> • Basic : The settings at "Speaker Setup" (page 75) are applied. • Custom : Make separate settings for 2-channel. Make the following settings: <p>Front : Set the front speaker size.</p> <ul style="list-style-type: none"> • Large : Use a large speaker that can adequately play back low frequencies. • Small : Use a small speaker that has inadequate playback capacity for low frequencies. <p> If "Speaker Config." – "Subwoofer" (page 75) is set to "No", the setting is automatically set to "Large".</p> <p>Subwoofer : Set the presence of a subwoofer.</p> <ul style="list-style-type: none"> • Yes : Use a subwoofer. • No : Select when a subwoofer is not connected. <p> If "Speaker Config." – "Subwoofer" (page 75) is set to "No", the setting is automatically set to "No". If the "Front" setting is "Small", the setting is automatically "Yes".</p> <p>Subwoofer Mode : Select low range signals to be reproduced by subwoofer.</p> <ul style="list-style-type: none"> • LFE : When the "2ch Direct/Stereo" – "Front" setting is set to "Large", the LFE signal alone is output from the subwoofer. Also, when the "2ch Direct/Stereo" – "Front" setting is set to "Small", the front channel low range signal is added to the LFE signal output from the subwoofer. • LFE+Main : The front channel low range signal is added to the LFE signal output from the subwoofer. <p> This setting can be set made "2ch Direct/Stereo" – "Subwoofer" is set to "Yes".</p> <p>Crossover : Set the maximum frequency of the bass signal output from each channel to the subwoofer.</p> <p>• 40Hz / 60Hz / <u>80Hz</u> / 90Hz / 100Hz / 110Hz / 120Hz / 150Hz / 200Hz / 250Hz</p> <p> • This setting can be set made "2ch Direct/Stereo" – "Subwoofer" is set to "Yes".</p> <p>• If the "2ch Direct/Stereo" – "Front" setting is "Large" and the "Subwoofer Mode" setting is "LFE", "Full Band" is displayed and the setting cannot be made.</p>





Setting items	Setting details
2ch Direct/Stereo (Continued)	Dist.FL / Dist.FR : Select the speaker. • 0.00m – 18.00m (3.60m) / 0.0ft – 60.0ft (12.0ft) : Set the distance to the speaker.  Set so that the difference between the front left speaker and front right speaker distances is 6.0 m (20.0 ft) or less.
Auto Surround Mode Make setting for memorizing surround mode setting for each input signal type.	Level FL / Level FR : Select the speaker. • -12.0dB – +12.0dB (0.0dB) : Adjust the level of each channel. ON : Memorize settings. Automatically play with the last used surround mode. OFF : Do not memorize settings. Surround mode does not change according to input signal.  <ul style="list-style-type: none"> The auto surround mode function lets you store in the memory the surround mode last used for playing the four types of input signals listed below. <ol style="list-style-type: none"> Analog and PCM 2-channel signals Dolby Digital and DTS 2-channel signals Dolby Digital and DTS multi-channel signals LPCM Multi-channel signals When playing in PURE DIRECT, the surround mode does not change even if the input signal is changed.
EQ Customize Set so that unused equalizer settings are not displayed when MULTEQ is pressed.	Audyssey Byp. L/R : Set when not using "Audyssey Byp. L/R" equalizer. • Used : Use. • Not Used : Do not use.  Set so that "Audyssey Byp. L/R" settings can be made when Audyssey® Auto Setup is performed.
	Audyssey Flat : Set when not using "Audyssey Flat" equalizer. • Used : Use. • Not Used : Do not use.  Set so that "Audyssey Flat" settings can be made when Audyssey Auto Setup is performed.
 <p>The equalizer mode in which "Not Used" is selected cannot be stored and recalled in the Quick Select function.</p>	Manual : Set when not using the "Manual" equalizer. • Used : Use. • Not Used : Do not use.

Network Setup

Default settings are underlined.

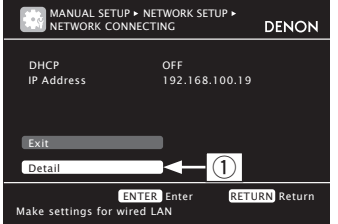
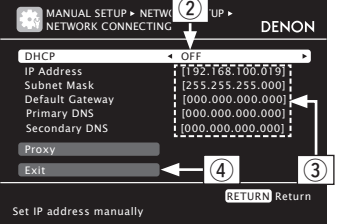

Make network settings.

Setting items	Setting details
Network Connecting Make settings for wired LAN.	<ol style="list-style-type: none"> Connect the LAN cable (☞ page 22 "Connecting to a home network (LAN)"). Turn on this unit (☞ page 6 "Turn on power"). This unit performs automatic network setup due to the DHCP function. When connecting to a network that has no DHCP function, perform the setting in step 3. Set the IP address at the "Network Connecting".
	 
	<ol style="list-style-type: none"> On the menu, select "Network Connecting" – "Detail" and press ENTER. Use \triangle \triangleright to set "DHCP" to "OFF", then press ∇. The DHCP function is disabled. Use \triangle \triangleright or 0–9 to input the address and press ENTER. 
	<ul style="list-style-type: none"> IP Address : Set the IP address within the ranges shown below. The Network Audio function cannot be used if other IP addresses are set. CLASS A: 10.0.0.0 – 10.255.255.255 CLASS B: 172.16.0.0 – 172.31.255.255 CLASS C: 192.168.0.0 – 192.168.255.255 Subnet Mask : When connecting an xDSL modem or terminal adapter directly to this unit, input the subnet mask indicated in the documentation supplied by your provider. Normally input 255.255.255.0. Default Gateway : When connected to a gateway (router), input its IP address. Primary DNS, Secondary DNS : If there is only one DNS address indicated in the documentation supplied by your provider, input it at "Primary DNS". If there are two or more DNS addresses, input the first one at "Secondary DNS".













Manual Setup

Setting items	Setting details
Network Connecting (Continued)	<p>④ Use ∇ to select "Exit" and press ENTER. Setup is complete.</p> <ul style="list-style-type: none"> When connecting to the network via a Proxy server, select "Proxy" and press ENTER (☞ page 80 "Proxy settings"). <p></p> <ul style="list-style-type: none"> If you are using a broadband router (DHCP function), there is no need to make the settings at "IP Address" and "Proxy", since the DHCP function is set to "ON" in this unit's default settings. If this unit is being used connected to a network without the DHCP function, the network settings must be made. In this case, some knowledge of networks is required. For details, consult a network administrator. If you cannot connect to the Internet, recheck the connections and settings (☞ page 22). If you do not understand about Internet connection, contact your ISP (Internet Service Provider) or the store from which you purchased your computer. When you want to cancel the setting during IP address input, press RETURN. <p>Proxy settings : Make this setting when connecting to the Internet via a proxy server.</p> <div style="display: flex; justify-content: space-around;"> <div style="border: 1px solid black; padding: 5px; width: 45%;"> <p>MANUAL SETUP ▶ NETWORK SETUP ▶ NETWORK CONNECTING DENON</p> <p>DHCP ON IP Address 192.168.100.19</p> <p>Exit</p> <p>Detail ← ①</p> <p>ENTER Enter RETURN Return Set IP address and proxy manually</p> </div> <div style="border: 1px solid black; padding: 5px; width: 45%;"> <p>MANUAL SETUP ▶ NETWORK SETUP ▶ NETWORK CONNECTING DENON</p> <p>DHCP ON IP Address [192.168.100.019] Subnet Mask [255.255.255.000] Default gateway [000.000.000.000] Primary DNS [000.000.000.000] Secondary DNS [000.000.000.000]</p> <p>Proxy ← ②</p> <p>Exit</p> <p>ENTER Enter RETURN Return Set if using proxy server</p> </div> </div> <div style="border: 1px solid black; padding: 5px; width: 45%; margin: 10px auto;"> <p>MANUAL SETUP ▶ NETWORK SETUP ▶ NETWORK CONNECTING DENON</p> <p>Proxy ON</p> <p>Address ← ④ [000.000.000.000]</p> <p>Port ← ⑥ [00000]</p> <p>Exit ← ⑦</p> <p>RETURN Return Proxy server is used</p> </div> <p>① On the menu, select "Network Connecting" – "Detail" and press ENTER.</p> <p>② Use $\Delta\nabla$ to set "Proxy" and press ENTER.</p> <p>③ Use $\triangleleft\triangleright$ to set "Proxy" to "ON" and press ∇. The proxy server is enabled.</p>

Setting items	Setting details
Network Connecting (Continued)	<p>④ Use $\triangleleft\triangleright$ to select the proxy server input method, and then press ∇. Address : Select when inputting by address. Name : Select when inputting by domain name.</p> <p>⑤ Use $\Delta\nabla\triangleleft\triangleright$ or 0-9 to input the proxy server address or domain name and press ENTER. When "Address" is selected in step ④ : Input the address When "Name" is selected in step ④ : Input the domain name</p> <ul style="list-style-type: none"> For character input, see page 61. <p>⑥ Use $\Delta\nabla\triangleleft\triangleright$ or 0-9 to input the proxy server port number and press ENTER.</p> <p>⑦ Use ∇ to select "Exit" and press ENTER. Setup is complete.</p>
Other Network function on/off setting during standby, and PC language setting.	<p>Network Standby : Set the network function on/off during standby.</p> <ul style="list-style-type: none"> ON : Network is on during standby. Main unit operable with a network compatible controller. OFF : Suspend network function during standby. <p> Set to "ON" when using the web control function.</p> <p>PC Language : Select computer environment language.</p> <p>ara / chi (smpl) / chi (trad) / cze / dan / dut / eng / fin / fre / ger / gre / heb / hun / ita / jpn / kor / nor / pol / por / por(BR) / rus / spa / swe / tur</p> <p>Friendly Name Edit : The Friendly Name is the name of this unit displayed on the network. Up to 63 characters can be input. The default Friendly Name on first use is "DENON:[AVR-3311]".</p> <ul style="list-style-type: none"> For character input, see page 61. <p>Default : Restores Friendly Name, which you had changed, to the default setting.</p> <ul style="list-style-type: none"> Yes : Reset to the defaults. No : Do not reset to the defaults. <p> When you select "Default" and press ENTER, the "Default Setting?" prompt is displayed. Select either "Yes" or "No", and press ENTER.</p> <p>Party Mode : Set the Party Mode.</p> <p>Party Mode Function : Set the Party Mode function.</p> <ul style="list-style-type: none"> ON : Enable party mode function. OFF : Disable party mode function. <p> Refer to page 53, "Party mode function" for more information on the party mode function.</p>









Setting items	Setting details
Other (Continued)	<p>Party Start Level : Make settings for volume level when the party mode is started.</p> <ul style="list-style-type: none"> • Last : The same volume as set before the party mode was started. • --- (0) : Always use the muting on condition when the party mode is started. • -80dB - 18dB (1 ~ 99) : Start party mode with your preferred volume. <p> This can be set when "Party Mode Function" is set to "ON".</p> <ul style="list-style-type: none"> • This is displayed from 0 to 99 when "Volume Display" ( page 82) is set to "Absolute". • You can set to the upper limit set with "Volume Limit" ( page 82) . <p>Network Status : Displays up to a maximum of 10 DENON products connected on the same network.</p> <ul style="list-style-type: none"> • Friendly Name / Party Mode Status / Model Name / Power ON/Standby / Select Source / Volume Level <p> "Network Status" is only displayed for DENON products supporting the Network Status function.</p> <p>Update Notification : Displays a notification message on this unit's menu screen when the latest firmware is released with "Firmware Update". The notification message is displayed for about 20 seconds when the power is turned on. Connect to broadband Internet ( page 22) when using this function.</p> <ul style="list-style-type: none"> • ON : Display update message. • OFF : Do not display update message. <p> When you press ENTER during display of the notification message, the "Check for Update" screen is displayed. (Refer to page 84 for more information on "Firmware Update")</p> <ul style="list-style-type: none"> • Press RETURN to erase the notification message. <p>Upgrade Notification : Display a notification message on this unit's menu screen when downloadable firmware is released with "Add New Feature". The notification message is displayed for about 20 seconds when the power is turned on. Connect to broadband Internet ( page 22) when using this function.</p> <ul style="list-style-type: none"> • ON : Display upgrade message. • OFF : Do not display upgrade message. <p> When you press ENTER during display of the notification message, the "Add New Feature" screen is displayed. (Refer to page 84 for more information on "Add New Feature")</p> <ul style="list-style-type: none"> • Press RETURN to erase the notification message.

Setting items	Setting details
Napster Account Set or change Username and Password ( page 35 "Listening to Napster").	Username / Password • For character input, see page 61.
Last.fm Account Set or change Username and Password ( page 37 "How to listen to Last.fm on this unit").	Username / Password / Clear • For character input, see page 61.
Last.fm Display Set whether or not to display Last.fm item on the menu.	Display : Display Last.fm item on the menu. Hidden : Do not display Last.fm item on the menu.
Network Information Display network information.	Friendly Name / DHCP= ON/OFF / IP Address / MAC Address

Zone Setup



Default settings are underlined.

Set the audio to play back with multi-zone (ZONE2, ZONE3).

Setting items	Setting details
Bass Adjust low frequency range (bass).	-10dB - +10dB (0dB)
Treble Adjust high frequency range (treble).	-10dB - +10dB (0dB)
HPF Make settings for cutting the low range to reduce distortion in the bass.	ON : The low range is attenuated. OFF : The low range is not attenuated.
Level Lch Adjust the left channel output level.	-12dB - +12dB (0dB)  The "Level Lch" can be set when "Channel" ( page 81) is set to "Stereo".
Level Rch Adjust the right channel output level.	-12dB - +12dB (0dB)  The "Level Rch" can be set when "Channel" ( page 81) is set to "Stereo".
Channel Set the signal output from multi-zone.	Stereo : Select stereo output. Mono : Select mono output.  When "Amp Assign" ( page 75) is set to "ZONE2/3-MONO", the "Channel" setting is automatically set to "Mono".



Manual Setup

Setting items	Setting details
Volume Level Set the volume output level.	Variable : Volume adjustment is enabled by main unit and remote control unit. -40dB (41) : Fix volume at -40 dB. Set when adjusting volume by external amplifier. 0dB (81) : Fix volume at 0 dB. Set when adjusting volume by external amplifier.  When "Amp Assign" (page 75) is set to "ZONE2", "ZONE3" or "ZONE2/3-MONO", the "Volume Level" setting is automatically set to "Variable".
Volume Limit Make a setting for maximum volume.	OFF : Do not set a maximum volume. -20dB (61) / -10dB (71) / 0dB (81)  <ul style="list-style-type: none"> This can be set when the multi-zone "Volume Level" setting (page 82) is "Variable". This is displayed from 0 to 99 when "Volume Display" (page 82) is set to "Absolute".
Power On Level Define the volume setting that is active when the power is turned on.	Last : Use the memorized setting from the last session. --- (0) : Always mute when power is turned on. -80dB - 18dB (1 - 99) : The volume is adjusted to the set level.  <ul style="list-style-type: none"> This can be set when the multi-zone "Volume Level" setting (page 82) is "Variable". This is displayed from 0 to 99 when "Volume Display" (page 82) is set to "Absolute".
Mute Level Set the amount of attenuation when muting is on.	Full : The sound is muted entirely. -40dB : The sound is attenuated by 40 dB down. -20dB : The sound is attenuated by 20 dB down.



Option Setup



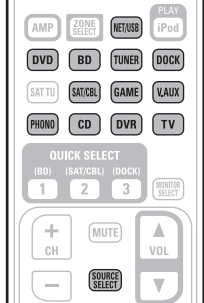

Default settings are underlined.

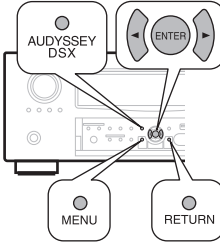
Make various other settings.

Setting items	Setting details
Volume Control Set the MAIN ZONE (room where the unit is located) volume setting.	Volume Display : Set how volume is displayed. <ul style="list-style-type: none"> Relative : Display -dB (Min), in the range -80.5 dB - 18 dB. Absolute : Display in the range 0 (Min) - 99.  <ul style="list-style-type: none"> The "Volume Display" setting is applied also to the "Volume Limit" and "Power On Level" display method. The "Volume Display" setting applies to all zones. Volume Limit : Make a setting for maximum volume. <ul style="list-style-type: none"> OFF : Do not set a maximum volume. -20dB (61) / -10dB (71) / 0dB (81) Power On Level : Define the volume setting that is active when the power is turned on. <ul style="list-style-type: none"> Last : Use the memorized setting from the last session. --- (0) : Always use the muting on condition when power is turned on. -80dB - 18dB (1 - 99) : The volume is adjusted to the set level. Mute Level : Set the amount of attenuation when muting is on. <ul style="list-style-type: none"> Full : The sound is muted entirely. -40dB : The sound is attenuated by 40 dB down. -20dB : The sound is attenuated by 20 dB down.
Source Delete Remove from the display input sources that are not used.	BD / DVD / TV / SAT/CBL / DVR / GAME / V.AUX / DOCK / NET/USB / TUNER / PHONO / CD : Select input source that is not used. <ul style="list-style-type: none"> ON : Use this source. Delete : Do not use this source. <div style="border: 1px solid black; padding: 5px; margin-top: 10px;"> <p>NOTE</p> <ul style="list-style-type: none"> Input sources being used in the various zones cannot be deleted. Input sources set to "Delete" cannot be selected using SOURCE SELECT. </div> 
GUI Make the settings related to displays on the TV screen.	Screensaver : Make screensaver settings. <ul style="list-style-type: none"> ON : The screensaver is activated during menu display, NET/USB, iPod or TUNER screen display if no operation is performed for an approximately 3-minute continuous period. When you press $\Delta \nabla \triangleleft \triangleright$, the screensaver is cancelled and the screen before that screen saver started is displayed. OFF : Screensaver is not activated.





Setting items	Setting details
GUI (Continued)	<p>Wall Paper : Set wallpaper to display in the background when playback is stopped, etc.</p> <ul style="list-style-type: none"> • Picture : Set the background to a picture (DENON logo). • Black : Set the background to black. <p>Format : Set the video signal format to be output for the TV you are using.</p> <ul style="list-style-type: none"> • NTSC : Select NTSC output. • PAL : Select PAL output. <p> "Format" can also be set by the following procedure. However, the menu screen is not displayed.</p> <ol style="list-style-type: none"> 1. Press and hold the main unit's AUDYSSEY DSX and RETURN for at least 3 seconds. "Video Format" appears on the display. 2. Press ◀▶ and set the video signal format. 3. Press the main unit's ENTER, MENU or RETURN to complete the setting.  <p>NOTE</p> <p>When a format other than the video format of the connected TV is set, the picture will not be displayed properly.</p> <p>Text : Display the details of operation when switching surround mode, input mode, etc.</p> <ul style="list-style-type: none"> • ON : Turn display on. • OFF : Turn display off. <p>Master Volume : Display the master volume during adjustment.</p> <ul style="list-style-type: none"> • Bottom : Display at the bottom. • Top : Display at the top. • OFF : Turn display off. <p> When the master volume display is hard to see when superimposed on movie subtitles, set to "Top".</p> <p>NET/USB : Set the NET/USB screen display time when the input source is "NET/USB".</p> <ul style="list-style-type: none"> • Always : Show display continuously. • 30sec : Show display for 30 seconds after operation. • 10sec : Show display for 10 seconds after operation. • OFF : Turn display off.

Setting items	Setting details
GUI (Continued)	<p>TUNER : Set the tuner screen display time when the input source is "TUNER".</p> <ul style="list-style-type: none"> • Always : Show display continuously. • 30sec : Show display for 30 seconds after operation. • 10sec : Show display for 10 seconds after operation. • OFF : Turn display off. <p>iPod : Set the iPod screen display time when the input source is "DOCK" or "iPod (USB)".</p> <ul style="list-style-type: none"> • Always : Show display continuously. • 30sec : Show display for 30 seconds after operation. • 10sec : Show display for 10 seconds after operation. • OFF : Turn display off.
Remote Preset Codes Search a preset code to register in the remote control unit.	See "Registering preset codes" ( page 87).
Quick Select Name Change the "Quick Select" display title to one you prefer.	<ul style="list-style-type: none"> • Up to 16 characters can be input. • For character input, see page 61.
Zone Rename Change the display title of each zone to one you prefer.	<ul style="list-style-type: none"> • Up to 10 characters can be input. • For character input, see page 61.
Trigger Out Select the condition for activating Trigger Out 1/2 for the input source, surround mode, etc. See "TRIGGER OUT jacks" ( page 23) for more information on trigger out.	<p>Trigger Out 1 / Trigger Out 2</p> <p><input type="checkbox"/> When setting for zone (MAIN ZONE / ZONE2 / ZONE3) Trigger out is activated through linkage to the power of the zone set to "ON".</p> <p><input type="checkbox"/> When setting for input source Activate trigger out when the input source set to "ON" is selected.</p> <p> Active for the zone set to "ON" with "When Setting for Zone".</p> <p><input type="checkbox"/> When setting for surround mode Activate trigger out when the surround mode set to "ON" is selected.</p> <p> Active when the "MAIN ZONE" set to "ON" with "When Setting for Zone" is selected, and when the input source set to "ON" with "When Setting for Input Source" is selected.</p> <p><input type="checkbox"/> When setting for HDMI monitor Activate trigger out when the HDMI monitor set to "ON" is selected.</p> <p> Active when the "MAIN ZONE" set to "ON" with "When Setting for Zone" is selected, and when the input source set to "ON" with "When Setting for Input Source" is selected.</p> <ul style="list-style-type: none"> • ON : Activate trigger on this mode. • --- : Do not activate trigger on this mode.



Manual Setup

Setting items	Setting details
Trigger Out (Continued)	Default : The "Trigger Out" settings are returned to the default settings. <ul style="list-style-type: none"> • Yes : Reset to the defaults. • No : Do not reset to the defaults.
Remote ID Setup Set when you operate another DENON AV amplifier with the remote control unit of this unit. Match the remote control unit you are using with the remote ID of this unit.	1 / 2 / 3 / 4 <p>NOTE</p> <p>When using this unit with only the included main remote control unit (RC-1146), use Remote ID "1" (default).</p> <p>When using the included sub remote control unit (RC-1148), this function can be used. Match the ID setting of the remote control unit and the receiver.</p>
Dimmer Adjust the display brightness of this unit.	Bright : Normal display brightness. Dim : Reduced display brightness. Dark : Very low display brightness. OFF : Turns the display off.
Setup Lock Protect settings from inadvertent change.	ON : Turn protection on. OFF : Turn protection off.  When canceling the setting, set "Setup Lock" to "OFF". <p>NOTE</p> <p>When "Setup Lock" is set to "ON", the settings listed below can no longer be changed. Also, "SETUP LOCKED!" is displayed if you attempt to operate related settings.</p> <ul style="list-style-type: none"> · Menu operations · RESTORER · Dynamic Volume® · Channel Level · MultEQ® XT · Dynamic EQ®
Maintenance Mode Use when receiving maintenance from a DENON service engineer or custom installer.	NOTE Only use this function if so instructed by a DENON serviceperson or installer.

Setting items	Setting details												
Firmware Update Update the firmware of the receiver.	Check for Update : Check for firmware updates. You can also check approximately how long it will take to complete an update. Start : Execute the update process. When updating starts, the power indicator becomes red and the menu screen is shut down. The amount of update time which has elapsed is displayed. When updating is complete, the power indicator becomes green and normal status is resumed. <ul style="list-style-type: none"> • If updating fails, the set automatically retries, but if updating is still not possible, one of the messages shown below is displayed. If the display reads as shown below, check the settings and network environment, then update again. <table border="1"> <thead> <tr> <th>Display</th> <th>Description</th> </tr> </thead> <tbody> <tr> <td>Updating fail</td> <td>Updating failed.</td> </tr> <tr> <td>Login failed</td> <td>Failure to log into server.</td> </tr> <tr> <td>Server is busy</td> <td>Server is busy. Wait a while then try again.</td> </tr> <tr> <td>Connection fail</td> <td>Failure in connecting to server.</td> </tr> <tr> <td>Download fail</td> <td>Downloading of the firmware has failed.</td> </tr> </tbody> </table>	Display	Description	Updating fail	Updating failed.	Login failed	Failure to log into server.	Server is busy	Server is busy. Wait a while then try again.	Connection fail	Failure in connecting to server.	Download fail	Downloading of the firmware has failed.
Display	Description												
Updating fail	Updating failed.												
Login failed	Failure to log into server.												
Server is busy	Server is busy. Wait a while then try again.												
Connection fail	Failure in connecting to server.												
Download fail	Downloading of the firmware has failed.												
Add New Feature Display new features that can be downloaded to this unit and perform an update.	Upgrade : Execute the upgrade process. When updating starts, the power indicator becomes red and the menu screen is shut down. The amount of update time which has elapsed is displayed. When upgrading is complete, the power indicator becomes green and normal status is resumed. <ul style="list-style-type: none"> • If the upgrade is not successful, an error message identical to those in "Firmware Update" will appear on the display. Check the settings and network environment, then update again. Upgrade Status : Display a list of the additional functions provided by the upgrade.  See the DENON website for details about updates. When the procedure is complete, "Registered" is displayed in this menu and updates can be carried out. If the procedure has not been carried out, "Not Registered" is displayed. The ID number shown on this screen is needed when carrying out the procedure. The ID number can also be displayed by pressing and holding ◀ and RETURN for at least 3 seconds.												

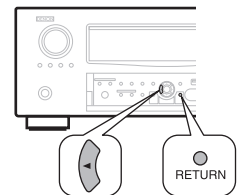

Manual Setup

Notes concerning use of "Firmware Update" and "Add New Feature"

- In order to use these functions, you must have the correct system requirements and settings for a broadband Internet connection (☞ page 22).
- Do not turn off the power until updating or upgrading is completed.
- Even with a broadband connection to the Internet, approximately 1 hour is required for the updating/upgrading procedure to be completed.
- Once updating/upgrade starts, normal operations on this unit cannot be performed until updating/upgrading is completed.
- Furthermore, updating/upgrading the firmware may reset the backup data for the parameters, etc. set for this unit.
- The following backup data may be erased after an update or upgrade.
 - Internet radio preset channel
 - Internet radio Recently Played data
 - Username registered for Flickr Contact
 - Data in Internet radio, media server and USB memory device
- If the update or upgrade fails, press and hold the **ON/STANDBY** on the unit for more than 5 seconds, or remove and re-insert the power cord. "Update retry" appears on the display and update restarts from the point at which update failed. If the error continues despite this, check the network environment.

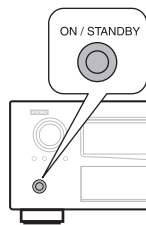

- Information regarding the "Firmware Update" function and "Add New Feature" will be announced on the DENON web site each time related plans are defined.
- When usable new firmware is released with "Firmware Update" or "Add New Feature", a notification message is displayed on the menu screen. When you do not want to be notified, set "Update Notification" (☞ page 81) and "Upgrade Notification" (☞ page 81) to "OFF".

Remote control operation buttons



Move the cursor
(Up/Down/Left/Right)





Confirm the setting



Return to previous menu

Information

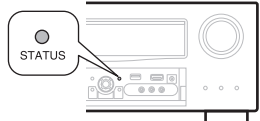
Show information about receiver settings, input signals, etc.

Items	Setting details
Status Show information about current settings.	<input type="checkbox"/> MAIN ZONE This item shows information about settings for MAIN ZONE. The information displayed differs according to the input source. Select Source / Name / Surround Mode / Input Mode / Decode Mode / HDMI / Digital / Component / Rec Select / Video Select / Video Mode / Content Type / Video Convert / i/p Scaler / Resolution / Progressive Mode / Aspect etc.
	<input type="checkbox"/> ZONE2 This item shows information about settings for ZONE2. Power / Select Source / Volume Level
	<input type="checkbox"/> ZONE3 This item shows information about settings for ZONE3. Power / Select Source / Volume Level
Audio Input Signal Show information about audio input signals.	<p>Surround Mode : The currently set surround mode. Signal : The input signal type. fs : The input signal's sampling frequency. Format : The number of channels in the input signal (front, surround, LFE). Offset : The dialogue normalization correction value. Flag : This is displayed when inputting signals including a surround back channel. "MATRIX" is displayed with Dolby Digital EX and DTS-ES Matrix signals, "DISCRETE" with DTS-ES Discrete signals.</p> <div style="border: 1px solid black; padding: 5px; margin: 10px 0;"> <p style="text-align: center;">Dialogue normalization function</p> <p>This function is automatically activated when playing Dolby Digital sources. It automatically corrects the standard signal level for individual program sources. The correction value can be checked using the STATUS.</p> <div style="display: flex; align-items: center; justify-content: center;"> <div style="border: 1px solid black; padding: 5px; margin-right: 10px;"> <p style="font-family: monospace; text-align: center;">Dial. Norm Offset - 4dB</p> </div>  </div> <p>The figure is the corrected value. This cannot be changed.</p> </div>
HDMI Information Show information about HDMI input/output signals and monitor.	<p>HDMI Signal Information • Resolution / Color Space / Pixel Depth</p> <p>HDMI Monitor 1 Information / HDMI Monitor 2 Information • Interface / Supported resol.</p> <p> "HDMI Monitor 1 Information" or "HDMI Monitor 2 Information" displays information on the HDMI monitor currently being used.</p>

Items	Setting details
Auto Surround Mode Show information about auto surround mode settings.	Analog/PCM 2ch / Digital 2ch / Digital 5.1ch / Multi ch
Quick Select Show information about "Quick select function" (page 52) settings.	Quick Select 1 / Quick Select 2 / Quick Select 3 / ZONE2 Quick Select 1 / ZONE2 Quick Select 2 / ZONE2 Quick Select 3 / ZONE3 Quick Select 1 / ZONE3 Quick Select 2 / ZONE3 Quick Select 3 • Name / Select Source / Video Select / Volume Level / MultEQ [®] XT / Dynamic EQ [®] / Dynamic Volume [®] / Analog/PCM 2ch / Digital 2ch / Digital 5.1ch / Multi ch
Preset Channel Show information about preset channels.	A / B / C / D / E / F / G A1 - A8 / B1 - B8 / C1 - C8 / D1 - D8 / E1 - E8 / F1 - F8 / G1 - G8
<div style="display: flex; justify-content: center; gap: 10px;"> <div style="border: 1px solid black; padding: 2px 5px;">TUNER</div> <div style="border: 1px solid black; padding: 2px 5px;">NET/USB</div> </div>	



Operating the connected devices by remote control unit

Operating the main remote control unit

Registering the supplied preset codes in the remote control unit enables you to operate devices made by other manufacturers.

Operating AV equipment

1 Press **ZONE SELECT** to select a zone for operation.

The zone mode indicator corresponding to the operating zone lights.

- The mode switches each time **ZONE SELECT** is pressed.

- MAIN** Select for the operations in MAIN ZONE.
- ZONE2** Select for the operations in ZONE2.
- ZONE3** Select for the operations in ZONE3.

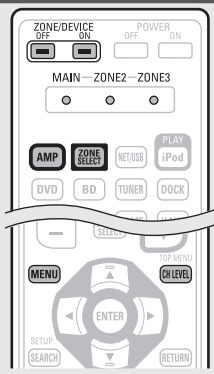

- #### 2 Press the input source select button (page 24).
- The input source for the zone selected in step 1 is switched.
 - The operation mode of the remote control unit is switched as shown in the table.

Input source select button	Input source of this unit	Devices controllable with the remote control unit (Operation mode)
AMP	–	This unit (amplifier operation)
BD *	BD	Device registered on the BD button
DVD *	DVD	Device registered on the DVD button
TV *	TV	Device registered on the TV button
SAT/CBL *	SAT/CBL	Device registered on the SAT/CBL button
DVR *	DVR	Device registered on the DVR button
GAME *	GAME	Device registered on the GAME button
V.AUX *	V.AUX	Device registered on the V.AUX button
CD *	CD	Device registered on the CD button
iPod	NET/USB or DOCK	iPod connected to the USB port or control dock for iPod.
DOCK	DOCK	Control dock for iPod
NET/USB	NET/USB	<ul style="list-style-type: none"> Network function iPod or USB memory device connected to the USB port
PHONO	PHONO	–
TUNER	TUNER	Radio of this unit

* If a preset code is registered for this button, the remote control unit of this unit can control another devices.

NOTE

If the mode of the remote control unit is set to other than amp-operation mode, press **AMP** to switch the remote control unit to the amp-operation mode to perform the following operations:

- For menu operation by pressing **MENU**
- For setting the channel level of the unit by pressing **CH LEVEL**
- For turning power in each zone on or off by pressing **ZONE/DEVICE ON** or **ZONE/DEVICE OFF**.

3 Operate this unit or the device whose input source is switched.

- For details, refer to the operating instructions for each device. For operations of iPod, TUNER and USB memory device, see the following pages.
 - iPod (page 26, 27)
 - TUNER (page 30)
 - Network function (page 33 – 38)
 - USB memory device (page 39)

Registering preset codes

When preset codes are registered in the included remote control unit, it can then be used to operate any devices you have, such as DVD players or TVs made by different manufacturers.

In this menu, you can search and display the preset codes that can be preset in the included remote control unit.

Buttons used for operating the devices

① **ZONE/DEVICE ON, ZONE/DEVICE OFF**

For switching power of each device on or off.

② **△ ▽ ◀ ▶, ENTER, RETURN**

For menu operation of each device.

③ **MENU, SETUP, TOP MENU**

For displaying the menu of each device.

④ **▶, ■, II, ◀◀, ▶▶, I◀◀, ▶▶I**

⑤ Number button (**0 – 9, +10**)

⑥ **CH +, CH –**

⑦ **TV POWER, TV INPUT**

For operating a TV

This button is enabled in any mode.

For details on operation with the remote control unit, see pages 26 – 39, 90.

Operating the main remote control unit

Default settings for preset codes

The devices shown below are registered for each input source button as default. Settings can be changed according to the devices to be used.

Input source select button	Category	Brand	Preset code
BD	Blu-ray Disc player	DENON	32258
DVD	DVD player	DENON	32134
TV	Television	SONY	10810
SAT/CBL	Satellite set top box	DirecTV	01377
DVR	DVD recorder	Tivo	20739
GAME	Cable set top box	Motorola	01376
V.AUX	DVD player	DENON	32134
DOCK*	Control dock for iPod	DENON	42517
CD	CD player	DENON	42867

* If a control dock for iPod is not to be used, the preset code for another device can be set to **DOCK**.

NOTE

- The preset code cannot be registered to **TUNER, NET/USB** or **SAT TU**.
- Do not register the preset code to **iPod**. This button also functions as the Play button for an iPod.

1 Press ZONE SELECT to switch the zone mode to "MAIN".

The "MAIN" indicator lights.

2 Press AMP to set the remote control unit to amplifier operation mode.

3 Press MENU.

The menu is displayed on the TV screen.

4 Use Δ / ∇ to select "Manual Setup" – "Option Setup" – "Remote Preset Codes" and then press ENTER or \triangleright .

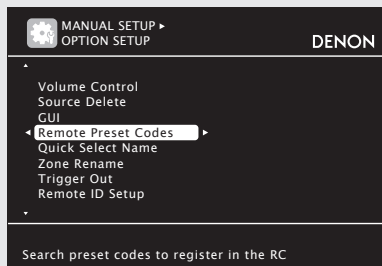

5 Pressing Δ / ∇ , select the category of device for preset registration. Then press ENTER or \triangleright .

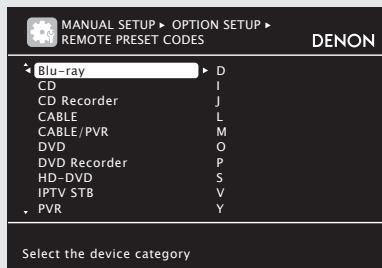

6 Pressing Δ / ∇ , select the first character of the brand name. Then press ENTER or \triangleright .

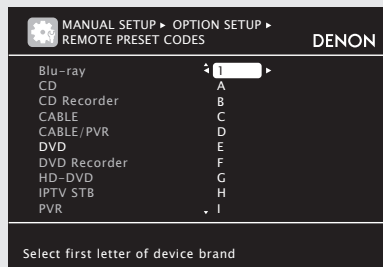

- The first character is displayed as 1, A to Z. (Initials for the brand are displayed for each category.) For brand names that start with numbers and symbols, select "1".

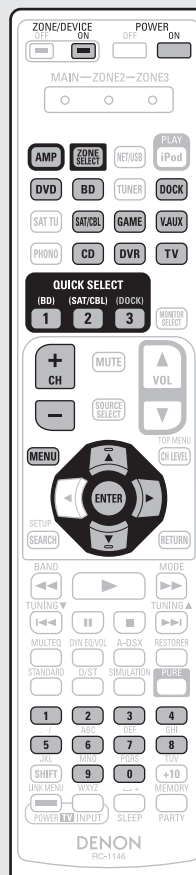

7 Pressing Δ / ∇ , select the brand name. Then press ENTER or \triangleright .

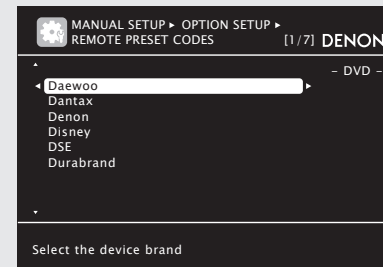

- When there are several pages of brand names, the pages can be switched by pressing the remote control unit's **CH +** or **CH -**.



NOTE

If the desired brand name is not listed, the supplied remote control unit cannot control the device. Use the remote control unit supplied with the device to be used.

8 The procedures for registering remote control codes and remote control preset registration are displayed.

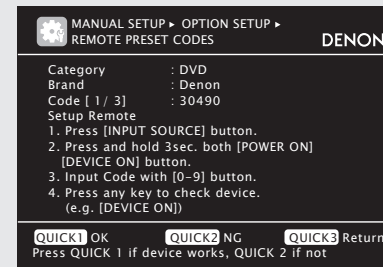

NOTE

If a wrong brand name is selected, press **QUICK SELECT 3**. The following screen is displayed:

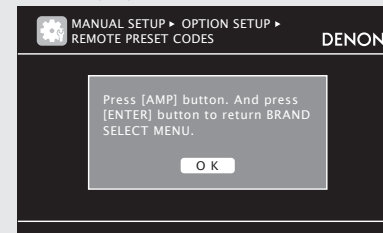

Press **AMP** then **ENTER** to return to step 7.

9 Press the input source button on which the preset code is to be registered (DVD, BD, SAT/CBL, DVR, DOCK, V.AUX, GAME, CD or TV).

- For **TV**, only the preset code for the categories "TV", "TV/DVD", or "TV/VCR" can be registered.
- For "TV", "TV/DVD", or "TV/VCR" categories, only the preset code for **TV** can be registered.

10 Hold POWER ON and ZONE/DEVICE ON pressed simultaneously for more than 3 seconds.

The zone mode indicator flashes twice.

11 Enter a five-digit code using 0 – 9.

Press the buttons with an interval less than 10 seconds.

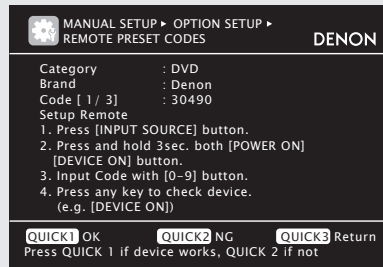

- When the code is registered.
→ The zone mode indicator flashes twice.
- When the code is not registered correctly
→ The mode indicator slowly flashes once. Perform from step 9 again.
- When an input number is not correct
→ Press **POWER ON** once then perform the operations from step 9 again.

12 Operate the device being used to check the operation.

- If the device is operating, press **QUICK SELECT 1**.
→ Go to step 13.
- If the device is not operating, press **QUICK SELECT 2**.
→ Go to step 14.

13 The screen shown below is displayed, and registration of the preset code is completed.

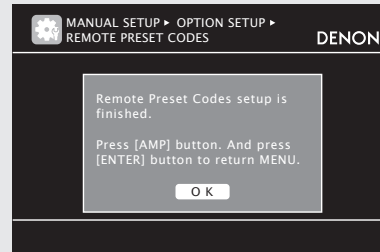

- The menu screen is retrieved. Press **AMP** then **ENTER**.

14 Either of the screens below is displayed.

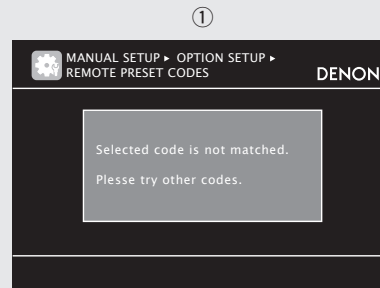

- The screen is displayed for 3 seconds, then the next preset registration screen is displayed automatically.

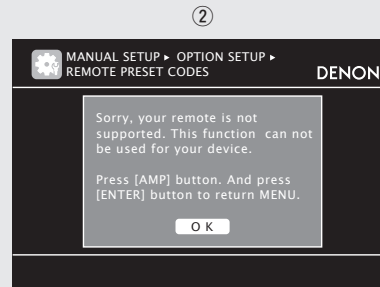

[If screen ① is displayed]

The device may be operating with the preset code displayed next. The preset registration screen is displayed. Repeat steps 9 to 12.

[If screen ② is displayed]

The device cannot be controlled with the remote control unit supplied with this unit. Use the remote control unit supplied with the device to be used. The menu screen is retrieved. Press **AMP** then **ENTER**.



Some manufacturers use more than one type of remote control code. Preset codes to change the number and verify correct operation.

NOTE

Depending on the model and year of manufacture of your equipment, some buttons may not operate.

Operating the main remote control unit

Operating components

The supplied remote control unit can control a component other than this unit.

1 Press the input source select button to which the preset code for the device you want to operate has been registered (☞ page 87).

2 Operate the component.

• For details, refer to the component's operating instructions.

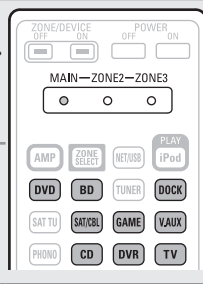

Blu-ray Disc player / HD-DVD player / DVD player / DVD recorder operation

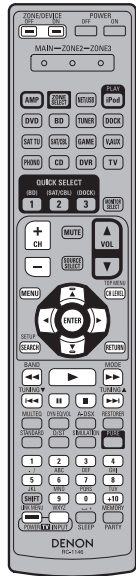

Operation buttons	Function
ZONE/DEVICE ON	Power on *
ZONE/DEVICE OFF	Power standby *
CH +, -	Switch channels (up/down)
MENU	(Popup) Menu
TOP MENU	Top menu
$\Delta \nabla \triangleleft \triangleright$	Cursor operation
ENTER	Enter
SETUP	Setup
RETURN	Return
$\lll \ggg$	Manual search (fast-reverse/fast-forward)
\blacktriangleright	Playback
$\lll \blacktriangleright \ggg$	Auto search (cue)
\parallel	Pause
\blacksquare	Stop
0 - 9, +10	Select title, chapter or channel selection
TV POWER	TV power on/standby (Default : SONY)
TV INPUT	Switch TV input (Default : SONY)

* This may power some devices on/standby.

CD player / CD recorder operation



Operation buttons	Function
ZONE/DEVICE ON	Power on *
ZONE/DEVICE OFF	Power standby *
$\Delta \nabla \triangleleft \triangleright$	Cursor operation
ENTER	Enter
$\lll \ggg$	Manual search (fast-reverse/fast-forward)
\blacktriangleright	Playback
$\lll \blacktriangleright \ggg$	Auto search (cue)
\parallel	Pause
\blacksquare	Stop
0 - 9, +10	Track selection
TV POWER	TV power on/standby (Default : SONY)
TV INPUT	Switch TV input (Default : SONY)

* This may power some devices on/standby.

Digital video recorder (PVR) / video cassette recorder (VCR) operation



Operation buttons	Function
ZONE/DEVICE ON	Power on *
ZONE/DEVICE OFF	Power standby *
CH +, -	Switch channels (up/down)
MENU	Menu
$\Delta \nabla \triangleleft \triangleright$	Cursor operation
ENTER	Enter
SETUP	Setup
RETURN	Return
$\lll \ggg$	Manual search (fast-reverse/fast-forward)
\blacktriangleright	Playback
$\lll \blacktriangleright \ggg$	Auto search (cue)
\parallel	Pause
\blacksquare	Stop
0 - 9, +10	Select title, chapter or channel selection
TV POWER	TV power on/standby (Default : SONY)
TV INPUT	Switch TV input (Default : SONY)

* This may power some devices on/standby.

TV operation



Operation buttons	Function
ZONE/DEVICE ON	Power on *
ZONE/DEVICE OFF	Power standby *
CH +, -	Switch channels (up/down)
MENU	Menu
$\Delta \nabla \triangleleft \triangleright$	Cursor operation
SETUP	Setup
ENTER	Enter
RETURN	Return
$\lll \ggg$	Manual search (fast-reverse/fast-forward)
\blacktriangleright	Playback
$\lll \blacktriangleright \ggg$	Auto search (cue)
\parallel	Pause
\blacksquare	Stop
0 - 9, +10	Channel selection
TV POWER	TV power on/standby (Default : SONY)
TV INPUT	Switch TV input (Default : SONY)

* This may power some devices on/standby.

Set top box for satellite (SAT) / cable (CBL) / IP TV operation



Operation buttons	Function
ZONE/DEVICE ON	Power on *
ZONE/DEVICE OFF	Power standby *
CH +, -	Switch channels (up/down)
MENU	Menu
$\Delta \nabla \triangleleft \triangleright$	Cursor operation
ENTER	Enter
SETUP	Guide
RETURN	Return
$\lll \ggg$	Manual search (fast-reverse/fast-forward)
\blacktriangleright	Playback
$\lll \blacktriangleright \ggg$	Auto search (cue)
\parallel	Pause
\blacksquare	Stop
0 - 9, +10	Channel selection
TV POWER	TV power on/standby (Default : SONY)
TV INPUT	Switch TV input (Default : SONY)

* This may power some devices on/standby.

Operating the main remote control unit

Specifying the zone used with the remote control unit

When the **ZONE SELECT** button is pressed, only the set zone can be operated with the remote control unit.

1 Press and hold POWER ON and ZONE/DEVICE ON for at least 3 seconds.
The zone mode indicator flashes twice.

2 Press ZONE SELECT.
The zone mode indicator flashes twice.

3 Press 1 – 3 to set.
The zone mode indicator flashes twice.

[Settable items]

- 1 When only using "MAIN ZONE"
- 2 When using "MAIN ZONE" / "ZONE2"
- 3 When using "MAIN ZONE" / "ZONE2" / "ZONE3" (Default)

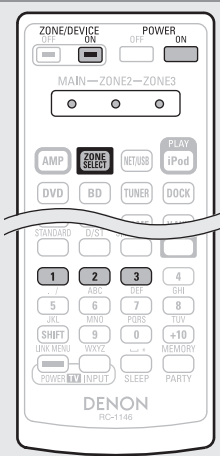

Resetting the remote control unit

Settings for the remote control unit are returned to the default values.

1 Press and hold POWER ON and ZONE/DEVICE ON for at least 3 seconds.
The zone mode indicator flashes twice.

2 Press 9, 8 and 1, in that order.
MAIN indicator flashes four times.
All the settings are restored to their defaults.

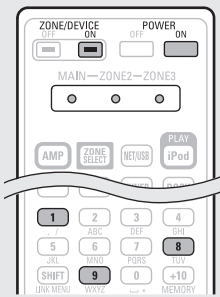

Operating the sub remote control unit

- The sub remote control unit is equipped with frequently used buttons, so it can be used for simple remote control unit operations.
- The sub remote control unit can also be used for multi-zone, so you can use it to control this unit from other rooms.
- The operations listed below can be performed with the sub remote control unit.
 - Switching the input source
 - Adjusting the volume
 - TUNER and iPod operations
 - NET/USB direct play
 - Menu operations
 - Zone power on/off
- It is not possible to operate devices other than the amplifier.

NOTE

This unit cannot be used in the ZONE4 mode.

DIRECT PLAY button

- Playback is possible in the mode selected at menu "Direct Play".
 - FAVORITES**
Playback starts from the first track registered in the favorites.
 - ALL MUSIC**
Playback starts from the first track registered in the "Music" folder.
- When **USB** is pressed, playback starts from the first track on the USB memory device.

NOTE

When the media server is stopped or restarted, it may no longer be possible to play tracks stored in the favorites.

Operating AV equipment

Use this procedure to select the zone to be operated by the sub remote control unit.

1 Press ZONE SELECT to select a zone for operation.

The zone mode indicator corresponding to the operating zone lights.

- The mode switches each time **ZONE SELECT** is pressed.

- M** Select for the operations in MAIN ZONE.
- Z2** Select for the operations in ZONE2.
- Z3** Select for the operations in ZONE3.
- Z4** Not used.

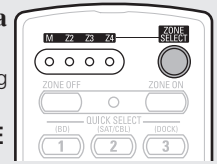

2 Press the input source select button.

- The input source for the zone selected in step 1 is switched.
- The operation mode of the remote control unit is switched as shown in the table.

Input source select button	Input source of this unit	Devices controllable with the remote control unit (Operation mode)
BD	BD	–
DVD	DVD	–
TV	TV	–
SAT/CBL	SAT/CBL	–
DVR	DVR	–
GAME	GAME	–
V.AUX	V.AUX	–
CD	CD	–
DOCK	DOCK	Control dock for iPod
NET/USB	NET/USB	<ul style="list-style-type: none"> • Network function • iPod or USB memory device connected to the USB port
PHONO	PHONO	–
TUNER, DTU	TUNER	Radio of this unit

Simple version

Basic version

Advanced version

Information

Operating the sub remote control unit

3 Operate this unit or the device whose input source is switched.

- For details, refer to the operating instructions for each device. For operations of iPod, TUNER and USB memory device, see the following pages.
 - iPod (page 92)
 - TUNER (page 93)
 - Network function (page 92)
 - USB memory device (page 92)

iPod operation

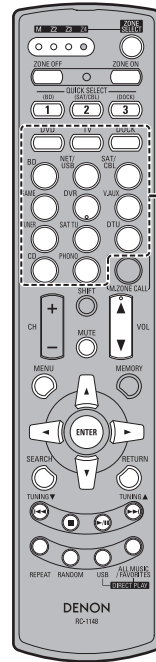

Operation buttons	Function		
	M	Z2	Z3
Zone selection			
ZONE SELECT	Zone operation mode selection		
ZONE OFF	Power turned off * 2		
ZONE ON	Power turned on * 2		
QUICK SELECT	Quick select operation		
INPUT SOURCE SELECT	Input source selection		
VOL +, -	Adjustment of volume * 2		
MUTE	Muting * 2		
MENU	Menu		-
△▽◀▶	Cursor operation		
ENTER	Enter		
SEARCH	Page forward screen / Browse/Remote mode switching (press and hold)		
RETURN	Return		
◀▶▶▶	Track search		
■	Stop		
▶/II	Playback / Pause		
REPEAT	1-track/All-track repeat play		
RANDOM	1-track/album shuffle play		
USB	* 3		
ALL MUSIC * 1 (Media server only)	* 4		
FAVORITES * 1	* 5		

- * 1 Whether "Music" or "Favorites" is selected depends on the "Direct Play" setting (page 68).
- * 2 Affects the currently selected zone.
- * 3 The input source switches to "NET/USB" and the files on the USB memory device are played.
- * 4 The input source switches to "NET/USB" and the files in "Music" on the media server are played.
- * 5 The input source switches to "NET/USB" and the files in "Favorites" are played.

NET/USB operation

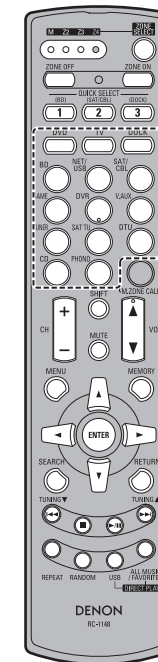

Operation buttons	Function		
	M	Z2	Z3
Zone selection			
ZONE SELECT	Zone operation mode selection		
ZONE OFF	Power turned off * 2		
ZONE ON	Power turned on * 2		
QUICK SELECT	Quick select operation		
INPUT SOURCE SELECT	Input source selection		
CH +, -	Preset channel selection		
SHIFT	Preset channel block selection		
VOL +, -	Adjustment of volume * 2		
MUTE	Muting * 2		
MENU	Menu		-
MEMORY	Favorites / Preset memory registration		
△▽◀▶	Cursor operation		
ENTER	Enter		
SEARCH	Page forward screen / Character search		
RETURN	Return		
◀▶▶▶	Track search		
■	Stop		
▶/II	Playback / Pause		
REPEAT	1-track/All-track repeat play		
RANDOM	1-track random play		
USB	* 3		
ALL MUSIC * 1 (Media server only)	* 4		
FAVORITES * 1	* 5		

- * 1 Whether "Music" or "Favorites" is selected depends on the "Direct Play" setting (page 68).
- * 2 Affects the currently selected zone.
- * 3 The input source switches to "NET/USB" and the files on the USB memory device are played.
- * 4 The input source switches to "NET/USB" and the files in "Music" on the media server are played.
- * 5 The input source switches to "NET/USB" and the files in "Favorites" are played.

□ Tuner (FM/AM) operation

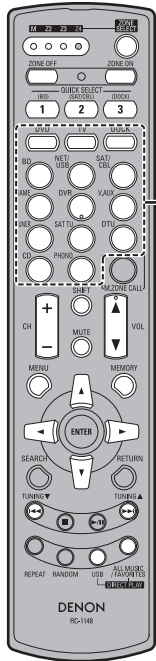

Operation buttons	Function		
	M	Z2	Z3
Zone selection			
ZONE SELECT	Zone operation mode selection		
ZONE OFF	Power turned off *2		
ZONE ON	Power turned on *2		
QUICK SELECT	Quick select operation		
INPUT SOURCE SELECT	Input source selection		
CH +, -	Preset channel selection		
SHIFT	Preset channel block selection		
VOL +, -	Adjustment of volume *2		
MUTE	Muting *2		
MENU	Menu	-	
MEMORY	Preset memory registration		
△▽◀▶	Cursor operation		
TUNING ▲▼	Tuning up/down		
USB	*3		
ALL MUSIC *1 (Media server only)	*4		
FAVORITES *1	*5		

- *1 Whether "Music" or "Favorites" is selected depends on the "Direct Play" setting (page 68).
- *2 Affects the currently selected zone.
- *3 The input source switches to "NET/USB" and the files on the USB memory device are played.
- *4 The input source switches to "NET/USB" and the files in "Music" on the media server are played.
- *5 The input source switches to "NET/USB" and the files in "Favorites" are played.

Switching the multi-zone input source to the same input source as used in the MAIN ZONE

This function is convenient for example when you want to listen to the same song as the one playing in the MAIN ZONE while in a different zone.

- 1 Press ZONE SELECT and set to ZONE2 or ZONE3.**
The currently selected multi-zone indicator illuminates.
- 2 Press M.ZONE CALL on the sub remote control unit.**
The multi-zone input source switches to the MAIN ZONE's input source.

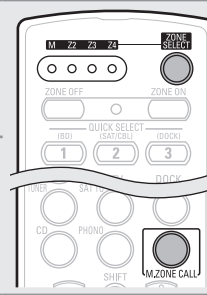

NOTE

- This function cannot be used for the MAIN ZONE.
- When **M.ZONE CALL** is pressed while the multi-zone power is off, the multi-zone power turns on and the input source switches to the MAIN ZONE's input source.

Setting the zone for which the sub remote control unit is used (Zone select lock mode)

We recommend always using the sub remote control unit for the same room. When this is done, the unit can be set so that the zone does not switch when buttons are operated.

- 1 Use the tip of a pen to press ADVANCED SETUP.**
All the multi-zone indicators illuminate.
- 2 Select the multi-zone to be set.**
The selected multi-zone indicator illuminates.

- ① To set to "MAIN ZONE"
Press **REPEAT**.
- ② To set to "ZONE2"
Press **RANDOM**.
- ③ To set to "ZONE3"
Press **USB**.
- ④ To set to "ZONE4"
Press **ALL MUSIC/FAVORITES**.

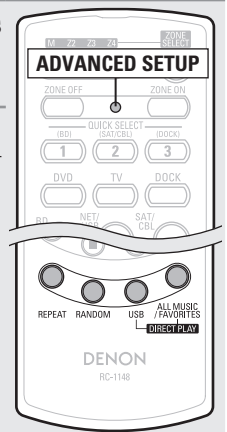

- 3 Use the tip of a pen to press ADVANCED SETUP.**
The multi-zone indicator turns off.

□ To cancel

- 1 Use the tip of a pen to press ADVANCED SETUP.**
The currently selected multi-zone indicator illuminates.
- 2 Press ZONE SELECT.**
All the multi-zone indicator illuminates.
- 3 Use the tip of a pen to press ADVANCED SETUP.**
The multi-zone indicator turns off.

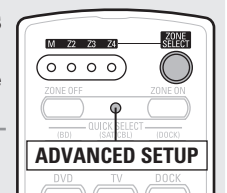

Operating the sub remote control unit

Setting the remote ID

When using multiple DENON AV receivers in the same room, make this setting so that no AV receiver other than the desired one operates.

1 While pressing **MENU**, press **ADVANCED SETUP** with the tip of a pen.

The multi-zone indicator corresponding to the currently selected remote ID flashes.

2 Select the remote ID to be set.

① To set to 1

Press **REPEAT**.
The "M" indicator flashes.

② To set to 2

Press **RANDOM**.
The "Z2" indicator flashes.

③ To set to 3

Press **USB**.
The "Z3" indicator flashes.

④ To set to 4

Press **ALL MUSIC/FAVORITES**.
The "Z4" indicator flashes.

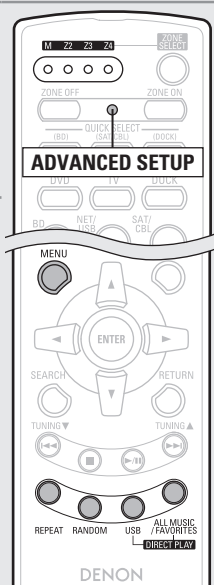

3 While pressing **MENU**, press **ADVANCED SETUP** with the tip of a pen.

The multi-zone indicator turns off.

NOTE

When changing a setting, be sure to set the same remote ID as this unit's (👉 page 84).

Resetting the settings

While pressing **ZONE OFF**, press **ADVANCED SETUP** with the tip of a pen.

All the multi-zone indicators flash four times, then all the settings are restored to their defaults.

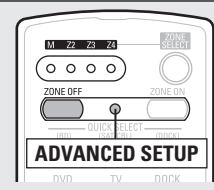

Information

Information

Here, we list various information related to this unit.
Please refer to this information as needed.

- Part names and functions 👉 page 95
- Other information 👉 page 100
- Troubleshooting 👉 page 108
- Specifications 👉 page 112
- Index 👉 page 113

Part names and functions

Front panel

For buttons not explained here, see the page indicated in parentheses ().

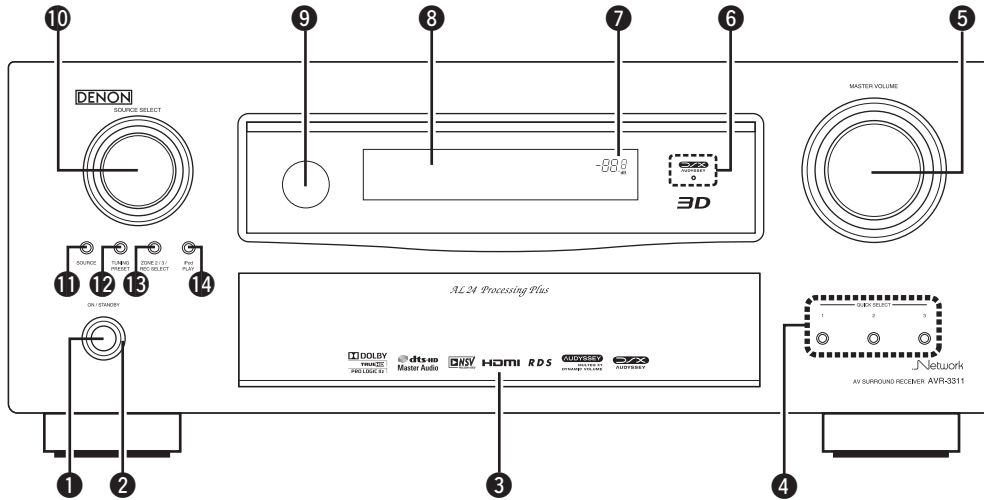

- 1 Power operation button (ON/STANDBY)** (6, 11)
Turns power to this unit on and off (standby).
- 2 Power indicator** (11)
- 3 Door**
When you are using buttons and/or terminals behind the door, press the bottom of the door to open it. When not using buttons and/or terminals behind the door, close it. Be careful not to catch your fingers when closing the door.

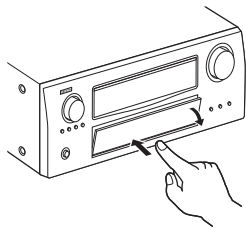

- 4 QUICK SELECT buttons** (52, 58)
- 5 MASTER VOLUME control knob** (24)
- 6 AUDYSSEY DSX™ indicator** (72)
- 7 Master volume indicator**
- 8 Display** (96)
- 9 Remote control sensor** (99)
- 10 SOURCE SELECT knob** (24, 58)
- 11 SOURCE button** (24)
- 12 TUNING PRESET button** (29)
- 13 ZONE2/3 / REC SELECT button** (52, 58)
- 14 iPod PLAY button** (28)

[With the door open]

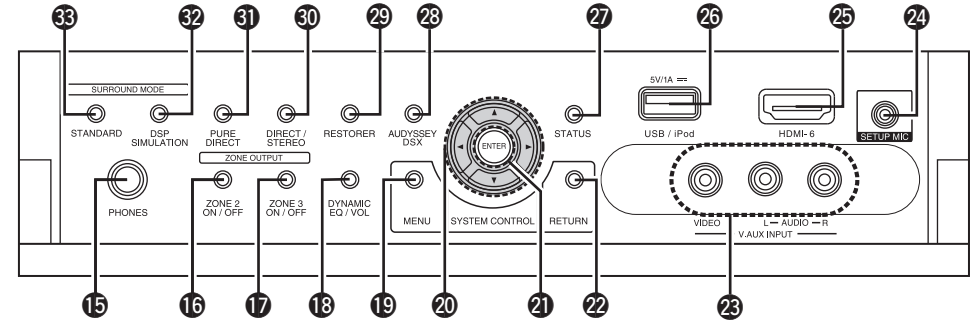

- 15 Headphones jack**
When the headphones are plugged into this jack, audio will no longer be output from the connected speakers or from the PRE OUT connectors.
- NOTE**
To prevent hearing loss, do not raise the volume level excessively when using headphones.
- 16 ZONE2 ON/OFF button** (58)
- 17 ZONE3 ON/OFF button** (58)
- 18 DYNAMIC EQ®/DYNAMIC VOLUME® button (DYNAMIC EQ/VOL)** (71, 72)
- 19 MENU button** (63)
- 20 Cursor buttons (Δ ▽ ◀ ▶)** (60 – 63)
- 21 ENTER button** (60 – 63)
- 22 RETURN button** (60 – 63)
- 23 V.AUX INPUT connectors** (18)
- 24 SETUP MIC jack** (8, 48)
- 25 HDMI IN connector** (15)
- 26 USB/iPod port** (19)
- 27 STATUS button** (86)
- 28 AUDYSSEY DSX button** (72)
- 29 RESTORER button** (73)
- 30 DIRECT/STEREO button** (42)
- 31 PURE DIRECT button** (42)
- 32 DSP SIMULATION button** (42)
- 33 STANDARD button** (40, 41)

Display

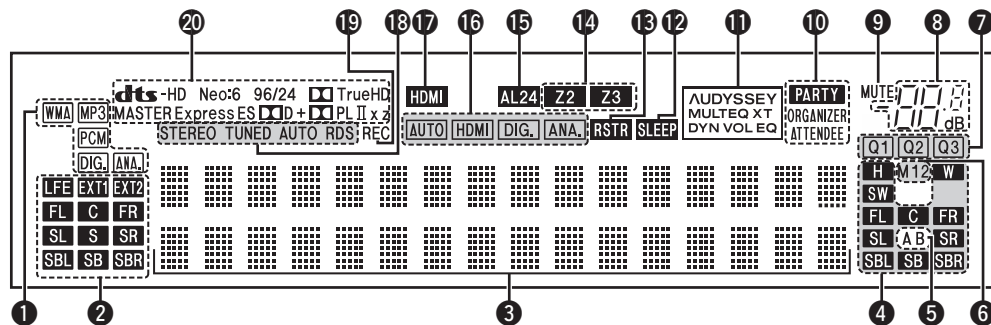

1 Input signal indicators

2 Input signal channel indicators

These light when digital signals are input. When playing HD Audio sources, the **EXT1** indicator lights when a signal from an extension channel (a channel other than the front, center, surround, surround back or LFE channel) is input. If there are two or more extension channels, the **EXT1** and **EXT2** indicators light.

3 Information display

The input source name, surround mode, setting values and other information are displayed here.

4 Output signal channel indicators

Lights when audio signals are being output from the speakers.

5 Front speaker indicator

This lights according to the setting of the front A and B speakers.

6 Monitor output indicator

These light according to the HDMI monitor output setting.

7 QUICK SELECT indicators

The indicator corresponding to the memory for which Quick Select function is set, lights (page 52 "Quick select function").

8 Master volume indicator

9 MUTE indicator

This lights when the mute mode is select (page 25).

10 PARTY indicators

These light during party mode (page 53 "Party mode function").

• ORGANIZER

This lights to indicate that party mode has started as Organizer.

• ATTENDEE

This lights to indicate that party mode has started as Attendee.

11 AUDYSSEY indicators

Lighting is as follows, depending on the setting of "Dynamic EQ" (page 71) and "Dynamic Volume" (page 72).

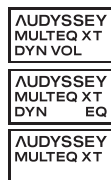

When "Dynamic EQ" and "Dynamic Volume" are "ON".

When "Dynamic EQ" is "ON" and "Dynamic Volume" is "OFF".

When "Dynamic EQ" and "Dynamic Volume" are "OFF".

12 Sleep timer indicator

This lights when the sleep mode is selected (page 51).

13 RESTORER indicator

This lights when the RESTORER mode is selected (page 73).

14 Multi-zone indicators

This lights up when ZONE2, ZONE3 (separate room) power is turned on (page 58).

15 AL24 indicator

This lights when AL24 Processing Plus (page 106) is activated.

16 Input mode indicators

Set the audio input modes for the different input sources (page 67).

17 HDMI indicator

This lights when playing using HDMI connections.

18 Tuner reception mode indicators

These light according to the reception conditions when the input source is set to "TUNER".

STEREO : In the FM mode, this light when receiving stereo broadcasts.

TUNED : Lights when the broadcast is properly tuned in.

AUTO : This light when in the auto tuning mode.

RDS : This light when receiving RDS broadcasts.

19 Recording output source indicator

This lights when the REC OUT mode is selected.

20 Decoder indicators

These light when the respective decoders are operating.

Rear panel

See the page indicated in parentheses ().

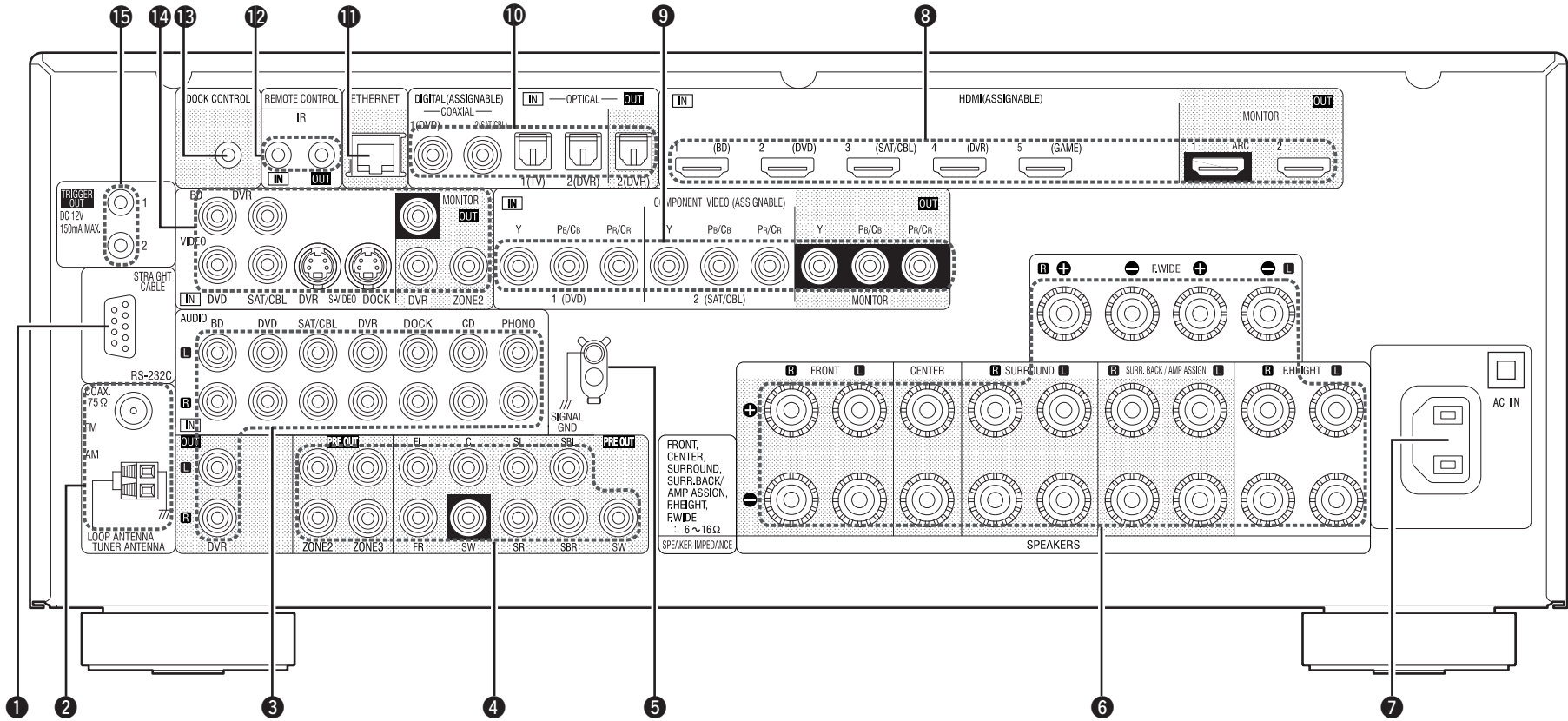

- ① RS-232C connector (23)
- ② FM/AM antenna terminals (20)
- ③ Analog audio connectors (16 – 18, 20, 21)
- ④ PRE OUT connectors (5, 21, 45 – 48)
- ⑤ SIGNAL GND terminal (20)
- ⑥ Speaker terminals (5, 45 – 48)
- ⑦ AC inlet (AC IN) (5)
- ⑧ HDMI connectors (15)
- ⑨ COMPONENT VIDEO connectors (16, 17)
- ⑩ Digital audio connectors (16 – 18)
- ⑪ ETHERNET connector (22)
- ⑫ REMOTE CONTROL jacks (23)
- ⑬ DOCK CONTROL jack (19)
- ⑭ S-VIDEO/VIDEO connectors (16 – 18)
- ⑮ TRIGGER OUT jacks (23)

NOTE

Do not touch the inner pins of the connectors on the rear panel. Electrostatic discharge may cause permanent damage to the unit.

Simple version

Basic version

Advanced version

Information

Remote control unit

For buttons not explained here, see the page indicated in parentheses ().

Main remote control unit (RC-1146)

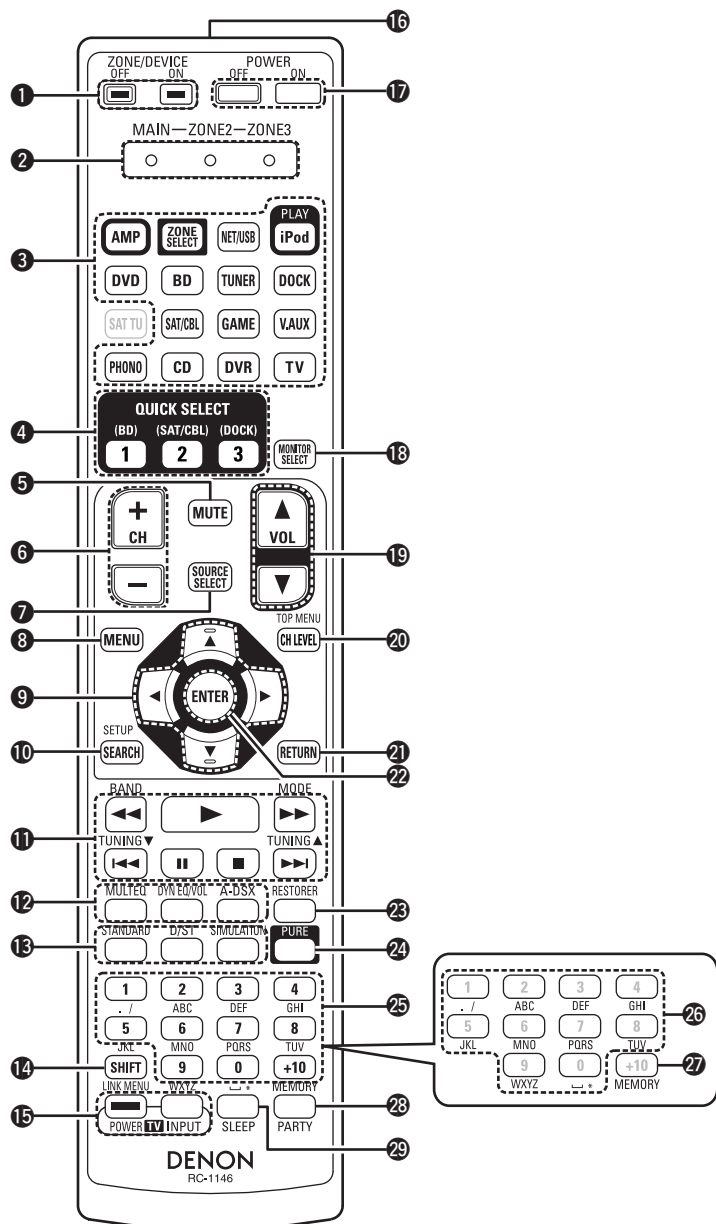

- 1 ZONE/DEVICE power buttons (58, 87)
- 2 Zone mode indicators (58, 87)
- 3 Input source select buttons (24, 58)
- 4 QUICK SELECT buttons (52, 58)
- 5 Muting button (MUTE) (25)
- 6 Channel buttons (CH) (28 – 30, 88)
- 7 SOURCE SELECT button (24, 58)
- 8 MENU button (63)
- 9 Cursor buttons (Δ ▽ ◀ ▶) (60 – 63)
- 10 SEARCH button (25, 29, 62)
- 11 System buttons (26, 27, 33 – 36, 38, 39, 90)
 - Search buttons (◀◀, ▶▶)
 - Skip buttons (◀◀◀, ▶▶▶)
 - Play button (▶)
 - Pause button (⏸)
 - Stop button (■)
- 12 Audyssey buttons (71, 72)
 - MULTEQ® XT button (MULTEQ)
 - Dynamic EQ®/DYNAMIC VOLUME® button (DYN EQ/VOL)
 - Audyssey DSX™ button (A-DSX)
- 13 Surround mode buttons (40 – 42)
 - STANDARD button
 - Direct / Stereo button (D/ST)
 - DSP simulation button (SIMULATION)
- 14 SHIFT button (28, 61)
- 15 TV operation buttons (TV POWER / INPUT) (90)
- 16 Remote control signal transmitter (99)
- 17 Power buttons (POWER ON / OFF) (6, 11)
- 18 Monitor select button (MONITOR SELECT) (15)
- 19 Master volume control buttons (VOL) (24)
- 20 Channel level button (CH LEVEL) (51)
- 21 RETURN button (60 – 63)
- 22 ENTER button (60 – 63)
- 23 RESTORER button (73)
- 24 Pure direct button (PURE) (42)
- 25 Number buttons (28, 29, 90)
- 26 Character buttons (61)
- 27 MEMORY button (28)
- 28 PARTY button (53)
- 29 Sleep timer button (SLEEP) (51)

Sub remote control unit (RC-1148)

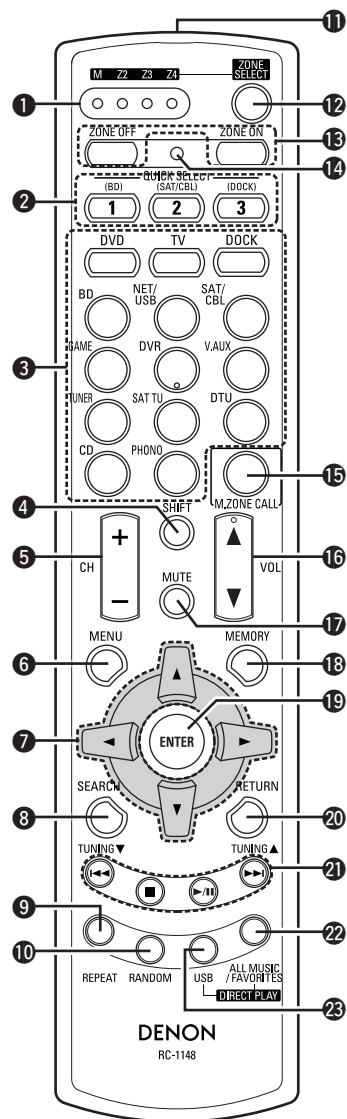

- ❶ **Zone indicators** (91)
- ❷ **QUICK SELECT buttons** (52, 58)
- ❸ **Input source select buttons** (24, 92, 93)
- ❹ **SHIFT button** (28, 61, 92, 93)
- ❺ **Channel buttons (CH)** (28 – 30, 88, 92, 93)
- ❻ **MENU button** (63, 92, 93)
- ❼ **Cursor buttons (▲▼◀▶)** (63, 92, 93)
- ❽ **SEARCH button** (29, 62, 92, 93)
- ❾ **REPEAT button** (92 – 94)
- ❿ **RANDOM button** (92 – 94)
- ⓫ **Remote control signal transmitter** (99)
- ⓬ **ZONE SELECT button** (92, 93)
- ⓭ **Zone power on/off buttons (ZONE ON, ZONE OFF)** (58)
- ⓮ **Advanced setup button** (93, 94)
- ⓯ **MAIN ZONE call button (M.ZONE CALL)** (93)
- ⓰ **Master volume control buttons (VOL)** (24, 58)
- ⓱ **Muting button (MUTE)** (25, 58)
- ⓲ **MEMORY button** (28, 92, 93)
- ⓳ **ENTER button** (60 – 63, 92)
- ⓴ **RETURN button** (60 – 63, 92)
- ⓵ **System buttons** (33 – 36, 38, 39, 90, 92, 93)
 - Skip buttons (⏮, ⏭)
 - Stop button (■)
 - Play/Pause button (⏮/⏭)
- ⓶ **Tuner system buttons** (28)
 - Tuning up / Tuning down buttons (TUNING ▲▼)
- ⓷ **ALL MUSIC/FAVORITES (DIRECT PLAY) button** (92, 93)
- ⓸ **USB (DIRECT PLAY) button** (92, 93)

Inserting the batteries

❶ Slide the rear lid in the direction of the arrow and remove it.

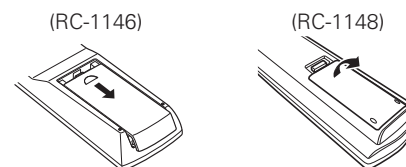

❷ Load the two batteries properly as indicated by the marks in the battery compartment.

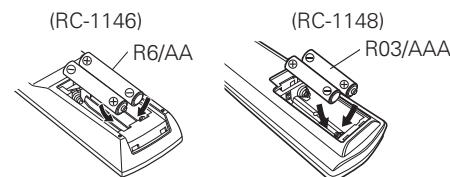

❸ Put the rear cover back on.

NOTE

- Insert the specified batteries in the remote control unit.
- Replace the batteries with new ones if the set does not operate even when the remote control unit is operated close to the unit. (The supplied batteries are only for verifying operation.)
- When inserting the batteries, be sure to do so in the proper direction, following the ⊕ and ⊖ marks in the battery compartment.
- To prevent damage or leakage of battery fluid:
 - Do not use a new battery together with an old one.
 - Do not use two different types of batteries.
 - Do not attempt to charge dry batteries.
 - Do not short-circuit, disassemble, heat or dispose of batteries in flames.
 - Do not keep the battery in a place exposed to direct sunlight or in places with extremely high temperatures, such as near a heater.
- If the battery fluid should leak, carefully wipe the fluid off the inside of the battery compartment and insert new batteries.
- Remove the batteries from the remote control unit if it will not be in use for long periods.
- Used batteries should be disposed of in accordance with the local regulations regarding battery disposal.

Operating range of the remote control unit

Point the remote control unit at the remote sensor when operating it.

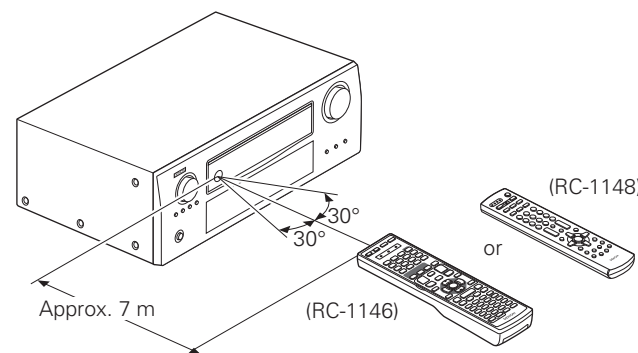

NOTE

The set may function improperly or the remote control unit may not operate if the remote control sensor is exposed to direct sunlight, strong artificial light from an inverter type fluorescent lamp or infrared light.

Other information

- ❑ **Trademark information** (👉 page 100)
- ❑ **Surround** (👉 page 101)
- ❑ **Relationship between video signals and monitor output** (👉 page 105)
- ❑ **Explanation of terms** (👉 page 106)

Trademark information

This product uses the following technologies:

	<p>Manufactured under license from Dolby Laboratories. "Dolby", "Pro Logic" and the double-D symbol are trademarks of Dolby Laboratories.</p>
	<p>Manufactured under license under U.S. Patent #'s: 5,451,942; 5,956,674; 5,974,380; 5,978,762; 6,226,616; 6,487,535; 7,212,872; 7,333,929; 7,392,195; 7,272,567 & other U.S. and worldwide patents issued & pending. DTS and the Symbol are registered trademarks, & DTS-HD, DTS-HD Master Audio, and the DTS logos are trademarks of DTS, Inc. Product includes software. © DTS, Inc. All Rights Reserved.</p>
	<p>HDMI, the HDMI Logo and High-Definition Multimedia Interface are trademarks or registered trademarks of HDMI Licensing LLC in the United States and other countries.</p>
	<p>Manufactured under license from Audyssey Laboratories™. U.S. and foreign patents pending. Audyssey MultEQ® XT is a registered trademark of Audyssey Laboratories. Audyssey Dynamic EQ® is a registered trademark of Audyssey Laboratories. Audyssey Dynamic Volume® is a trademark of Audyssey Laboratories. Audyssey Dynamic Surround Expansion™ is a trademark of Audyssey Laboratories.</p>



"Made for iPod" and "Made for iPhone" mean that an electronic accessory has been designed to connect specifically to iPod, or iPhone, respectively, and has been certified by the developer to meet Apple performance standards. Apple is not responsible for the operation of this device or its compliance with safety and regulatory standards. Please note that the use of this accessory with iPod, or iPhone, may affect wireless performance. iPhone, iPod, iPod classic, iPod nano, iPod shuffle, and iPod touch are trademarks of Apple Inc., registered in the U.S. and other countries.

- Individual users are permitted to use iPhone, iPod, iPod classic, iPod nano, iPod shuffle, and iPod touch for private copy and playback of non-copyrighted contents and contents whose copy and playback is permitted by law. Copyright infringement is prohibited by law.

This item incorporates copy protection technology that is protected by U.S. patents and other intellectual property rights of Rovi Corporation. Reverse engineering and disassembly are prohibited.

Surround

This unit is equipped with a digital signal processing circuit that lets you play program sources in the surround mode to achieve the same sense of presence as in a movie theater.

Surround modes and parameters

This table shows the speakers that can be used in each surround mode and the surround parameters adjustable in each surround mode.

Symbols in the table

- This indicates the audio output channels or surround parameters that can be set.
- ◎ This indicates the audio output channels. The output channels depend on the settings of "Speaker Config." (page 75).

Surround mode (page 40)	Channel output							Surround Parameter (page 69)							
	Front L/R	Center	Surround L/R	Surround back L/R	Front height L/R	Front wide L/R	Subwoofer	Mode (page 69)	Cinema EQ. * 5 (page 69)	DRC * 9 (page 69)	D. Comp * 10 (page 69)	LFE * 11 (page 69)	Delay Time (page 69)	Effect Lev. (page 69)	Room Size (page 69)
PURE DIRECT	○						◎ * 3			○	○	○			
DIRECT (2channel)	○						◎ * 3			○	○	○			
DIRECT (Multi-channel)	○	◎	◎	◎ * 1	◎ * 1	◎ * 1	◎			○	○	○			
STEREO	○						◎			○	○	○			
MULTI CH IN	○	◎	◎	◎	◎ * 2		◎					○			
DOLBY PRO LOGIC IIz	○	◎	◎	◎	◎		◎	○ * 4	○	○	○	○			
DOLBY PRO LOGIC IIx	○	◎	◎	◎			◎	○	○ * 6	○	○	○			
DOLBY PRO LOGIC II	○	◎	◎				◎	○	○ * 7	○	○	○			
DOLBY PRO LOGIC	○	◎	◎				◎	○	○ * 7	○	○	○			
DOLBY PRO LOGIC II A-DSX	○	◎	◎		◎ * 12	◎ * 13	◎	○	○ * 7	○	○	○			
DOLBY PRO LOGIC A-DSX	○	◎	◎		◎ * 12	◎ * 13	◎	○	○ * 7	○	○	○			
DTS NEO:6	○	◎	◎	◎			◎	○	○ * 6	○	○	○			
DTS NEO:6 A-DSX	○	◎	◎		◎ * 12	◎ * 13	◎	○	○ * 6	○	○	○			
Audyssey DSX	○	◎	◎		◎ * 12	◎ * 13	◎			○	○	○			
DOLBY DIGITAL	○	◎	◎	◎	◎ * 2		◎		○ * 8		○	○			
DOLBY DIGITAL Plus	○	◎	◎	◎	◎ * 2		◎		○ * 8		○	○			
DOLBY TrueHD	○	◎	◎	◎	◎ * 2		◎		○ * 8	○		○			
DTS SURROUND	○	◎	◎	◎	◎ * 2		◎		○ * 8		○	○ * 11			
DTS 96/24	○	◎	◎	◎	◎ * 2		◎		○ * 8		○	○			
DTS-HD	○	◎	◎	◎	◎ * 2		◎		○ * 8		○	○			
DTS Express	○	◎	◎	◎	◎ * 2		◎		○ * 8		○	○			
MULTI CH STEREO	○	◎	◎	◎ * 14	◎ * 15	◎ * 16	◎				○	○			
ROCK ARENA	○	◎	◎	◎ * 14	◎ * 15	◎ * 16	◎				○	○		○	○
JAZZ CLUB	○	◎	◎	◎ * 14	◎ * 15	◎ * 16	◎				○	○		○	○
MONO MOVIE	○	◎	◎	◎ * 14	◎ * 15	◎ * 16	◎				○	○		○	○
VIDEO GAME	○	◎	◎	◎ * 14	◎ * 15	◎ * 16	◎				○	○		○	○
MATRIX	○	◎	◎	◎ * 14	◎ * 15	◎ * 16	◎				○	○	○		○
VIRTUAL	○						◎ * 3				○	○			

- * 1 A signal for each channel contained in an input signal is output as audio.
- * 2 If "Surround Parameter" – "F.Height" (page 69) is set to "ON", sound is output from the front height speakers.
- * 3 Only when "Subwoofer Mode" is set to "LFE+Main" (page 76), sound is output from the subwoofer.
- * 4 If this surround mode is selected, only the "Height" mode setting is available for "Surround Parameter" – "Mode" (page 69).
- * 5 For HD Audio whose sampling frequency of an input signal is more than 96 kHz, this sound parameter cannot be set.
- * 6 This item can be selected when "Surround Parameter" – "Mode" (page 69) is set to "Cinema".
- * 7 This item can be selected when "Surround Parameter" – "Mode" (page 69) is set to "Cinema" or "Pro Logic".
- * 8 This item cannot be set when "Surround Parameter" – "S.Back" (page 70) is set to "PLIIx Music".
- * 9 This item can be selected when a Dolby TrueHD signal is played.
- * 10 This item can be selected when a Dolby Digital or DTS signal is played.
- * 11 This item can be selected when a Dolby Digital or DTS signal or DVD-Audio is played.
- * 12 If "Audyssey DSX" (page 72) is set to "ON-Height-", sound is output from the front height speakers.
- * 13 If "Audyssey DSX" (page 72) is set to "ON-Wide-", sound is output from the front wide speakers.
- * 14 If "Surround Parameter" – "Speaker" – "S.Back" (page 70) is set to "ON", sound is output from the surround back speakers.
- * 15 If "Surround Parameter" – "Speaker" – "F.Height" (page 70) is set to "ON", sound is output from the front height speakers.
- * 16 If "Surround Parameter" – "Speaker" – "F.Wide" (page 70) is set to "ON", sound is output from the front wide speakers.

Simple version

Basic version

Advanced version

Information

Surround

Surround mode (page 40)	Surround Parameter (page 69)										Tone * 19 (page 70)	Audyssey Settings * 24 (page 71)			Audyssey DSX™ * 24 * 25 (page 72)	RESTORER * 23 (page 73)
	AFDM * 11 (page 70)	S.Back (page 70)	F.Height * 17 (page 69)	Height Gain * 18 (page 70)	Speaker (page 70)	Subwoofer (page 70)	PRO LOGIC II/IIx Music mode only			NEO:6 Music mode only (page 69)		MultEQ® XT (page 71)	Dynamic EQ® * 21 (page 71)	Dynamic Volume® * 22 (page 72)		
							Panorama (page 69)	Dimension (page 69)	C.Width (page 69)							
PURE DIRECT																
DIRECT (2 channel)																
DIRECT (Multi-channel)																
STEREO																
MULTI CH IN	○	○	○	○												
DOLBY PRO LOGIC IIz			○	○												
DOLBY PRO LOGIC IIx		○					○	○	○							
DOLBY PRO LOGIC II		○	○				○	○	○							
DOLBY PRO LOGIC		○	○				○	○	○							
DOLBY PRO LOGIC II A-DSX							○	○	○							
DOLBY PRO LOGIC A-DSX							○	○	○							
DTS NEO:6		○								○						
DTS NEO:6 A-DSX										○						
Audyssey DSX																
DOLBY DIGITAL	○	○	○	○												
DOLBY DIGITAL Plus	○	○	○	○												
DOLBY TrueHD	○	○	○	○												
DTS SURROUND	○	○	○	○												
DTS 96/24	○	○	○	○												
DTS-HD	○	○	○	○												
DTS Express	○	○	○	○												
MULTI CH STEREO		○			○											
ROCK ARENA		○			○											
JAZZ CLUB		○			○											
MONO MOVIE		○			○											
VIDEO GAME		○			○											
MATRIX		○			○											
VIRTUAL																

- * 3 Only when "Subwoofer Mode" is set to "LFE+Main" (page 76), sound is output from the subwoofer.
- * 17 If "Speaker Config." – "F.Height" (page 75) is set to "None", this item cannot be selected.
- * 18 This item can be selected when "Surround Parameter" – "F.Height" (page 69) is set to "ON".
- * 19 This item cannot be set when "Dynamic EQ" (page 71) is set to "ON".
- * 20 In this surround mode, bass is +6 dB, and treble is +4 dB. (Default)
- * 21 This item cannot be set when "MultEQ XT" (page 71) is set to "OFF" or "Manual".
- * 22 This item cannot be set when "Dynamic EQ" (page 71) is set to "OFF".
- * 23 This item can be set when the input signal is analog, PCM 48 kHz or 44.1 kHz.
- * 24 For HD Audio whose sampling frequency of an input signal is more than 96 kHz, this sound parameter cannot be set.
- * 25 This item can not be selected when "Surround Parameter" – "F.Height" (page 69) is set to "ON".

Types of input signals, and corresponding surround modes

This table shows the input signal that can be played in each surround mode. Check the audio signal of the input source then select the surround mode.

Symbols in the table

- This indicates the default surround mode.
- ⊙ This indicates the surround mode that is fixed when "AFDM" (page 70) is set to "ON".
- This indicates the selectable surround mode.

Surround mode (page 40)	NOTE	Input signal types and formats																
		ANALOG	PCM		DTS-HD		DTS					DOLBY		DOLBY DIGITAL				
			LINEAR PCM (multi ch)	LINEAR PCM (2ch)	DTS-HD Master Audio	DTS-HD High Resolution Audio	DTS EXPRESS	DTS ES DSCRT (With Flag)	DTS ES MTRX (With Flag)	DTS (5.1ch)	DTS 96/24	DOLBY TrueHD	DOLBY DIGITAL Plus	DOLBY DIGITAL EX (With Flag)	DOLBY DIGITAL EX (With no Flag)	DOLBY DIGITAL (5.1/5/4ch)	DOLBY DIGITAL (4/3ch)	DOLBY DIGITAL (2ch)
DTS SURROUND																		
DTS-HD MSTR	*5			●														
DTS-HD HI RES	*5				●													
DTS ES DSCRT6.1	*1*3							●	⊙									
DTS ES MTRX6.1	*1*3							●	⊙									
DTS SURROUND	*5								○	●								
DTS 96/24	*5										●							
DTS (-HD) + PLIIx CINEMA	*2*3			○	○	○	○	○	○	○	○							
DTS (-HD) + PLIIx MUSIC	*1*3			○	○	○	○	○	○	○	○							
DTS (-HD) + PLIIz	*4			○	○	○	○	○	○	○	○							
DTS EXPRESS	*5					●												
DTS (-HD) + NEO:6	*1*3			○	○	○			○	○	○							
DTS NEO:6 CINEMA	*5	○	○															○
DTS NEO:6 MUSIC	*5	○	○															○
DTS NEO:6 CINEMA A-DSX		○	○															○
DTS NEO:6 MUSIC A-DSX		○	○															○
Audyssey DSX				○	○	○	○	○	○	○								
DOLBY SURROUND																		
DOLBY TrueHD	*5											●						
DOLBY DIGITAL+	*5												●					
DOLBY DIGITAL EX	*1*3													○	○	○	○	
DOLBY (D+) (HD) +EX	*1*3											○	○					
DOLBY DIGITAL	*5													○	●	●	●	
DOLBY (D) (D+) (HD) +PLIIx CINEMA	*2*3											○	○	●	⊙	○	○	○
DOLBY (D) (D+) (HD) +PLIIx MUSIC	*1*3											○	○	○	○	○	○	
DOLBY (D) (D+) (HD) +PLIIz	*4											○	○	○	○	○	○	
DOLBY PRO LOGIC IIx CINEMA	*1*3	○	○															○
DOLBY PRO LOGIC IIx MUSIC	*1*3	○	○															○
DOLBY PRO LOGIC IIx GAME	*1*3	○	○															○
DOLBY PRO LOGIC IIz	*4	○	○															○
DOLBY PRO LOGIC II CINEMA	*5	○	○															○
DOLBY PRO LOGIC II MUSIC	*5	○	○															○
DOLBY PRO LOGIC II GAME	*5	○	○															○
DOLBY PRO LOGIC	*5	○	○															○

*1 If "Speaker Config." - "S.Back" (page 75) is set to "None", this surround mode cannot be selected. *2 If "Speaker Config." - "S.Back" (page 75) is set to "1spkr" or "None", this surround mode cannot be selected. *3 This surround mode can be selected when "Amp Assign" (page 75) is set to "Normal". *4 If "Speaker Config." - "F.Height" (page 75) is set to "None", this surround mode cannot be selected. *5 The same was when "Audyssey DSX™" (page 72) setting is set to "ON".

Simple version

Basic version

Advanced version

Information

Surround

Surround mode (page 40)	NOTE	Input signal types and formats																
		ANALOG	PCM		DTS-HD		DTS					DOLBY		DOLBY DIGITAL				
			LINEAR PCM (multi ch)	LINEAR PCM (2ch)	DTS-HD Master Audio	DTS-HD High Resolution Audio	DTS EXPRESS	DTS ES DSCRT (With Flag)	DTS ES MTRX (With Flag)	DTS (5.1ch)	DTS 96/24	DOLBY TrueHD	DOLBY DIGITAL Plus	DOLBY DIGITAL EX (With Flag)	DOLBY DIGITAL EX (With no Flag)	DOLBY DIGITAL (5.1/5/4ch)	DOLBY DIGITAL (4/3ch)	DOLBY DIGITAL (2ch)
DOLBY SURROUND																		
DOLBY PRO LOGIC II CINEMA A-DSX		○	○														○	
DOLBY PRO LOGIC II MUSIC A-DSX		○	○														○	
DOLBY PRO LOGIC II GAME A-DSX		○	○														○	
DOLBY PRO LOGIC A-DSX		○	○														○	
Audyssey A-DSX												○	○	○	○	○	○	
MULTI CH IN																		
MULTI CH IN	* 5		●															
MULTI CH IN + PLIIx CINEMA	* 2 * 3		○															
MULTI CH IN + PLIIx MUSIC	* 1 * 3		○															
MULTI CH IN + PLIIz	* 4		○															
MULTI CH IN + Dolby EX	* 3		○															
MULTI CH IN 7.1	* 3		● ◎ (7.1)															
Audyssey A-DSX			○															
DIRECT																		
DIRECT		○	○	○	○	○	○	○	○	○	○	○	○	○	○	○	○	○
PURE DIRECT																		
PURE DIRECT		○	○	○	○	○	○	○	○	○	○	○	○	○	○	○	○	○
DSP SIMULATION																		
MULTI CH STEREO		○	○	○				○	○	○	○			○	○	○	○	
ROCK ARENA		○	○	○				○	○	○	○			○	○	○	○	
JAZZ CLUB		○	○	○				○	○	○	○			○	○	○	○	
MONO MOVIE		○	○	○				○	○	○	○			○	○	○	○	
VIDEO GAME		○	○	○				○	○	○	○			○	○	○	○	
MATRIX		○	○	○				○	○	○	○			○	○	○	○	
VIRTUAL		○	○	○				○	○	○	○			○	○	○	○	
STEREO																		
STEREO		●	○	●	○	○	○	○	○	○	○	○	○	○	○	○	○	○

- * 1 If "Speaker Config." - "S.Back" (page 75) is set to "None", this surround mode cannot be selected.
- * 2 If "Speaker Config." - "S.Back" (page 75) is set to "1spkr" or "None", this surround mode cannot be selected.
- * 3 This surround mode can be selected when "Amp Assign" (page 75) is set to "Normal".
- * 4 If "Speaker Config." - "F.Height" (page 75) is set to "None", this surround mode cannot be selected.
- * 5 The same was when "Audyssey DSX™" (page 72) setting is set to "ON".

Relationship between video signals and monitor output

MAIN ZONE MONITOR OUT											
	Video Convert	Input Signals				Output Signals			Menu displayed		
		HDMI	COMPONENT	S-VIDEO	VIDEO	HDMI	COMPONENT	VIDEO	HDMI	COMPONENT	VIDEO
1	ON	×	×	×	×	Wall paper	×	×	Only the menu is displayed	×	×
2	OFF	×	×	×	×		×	×		×	×
3	ON	×	×	×	○	VIDEO	VIDEO	VIDEO	○ (VIDEO)	×	×
4	ON	×	×	○	×	S-VIDEO	S-VIDEO	S-VIDEO	○ (S-VIDEO)	×	×
5	ON	×	×	○	○						
6	ON	×	○ (1080p)	×	×			×		×	
7	ON	×	○ (1080i ~ 480p)	×	×	COMPONENT		×	○ (COMPONENT)	×	×
8	ON	×	○ (480i/576i)	×	×			×		×	
9	ON	×	○ (1080p)	×	○					×	
10	ON *1	×	○ (1080p)	×	○	-		VIDEO	-	○ (VIDEO)	×
11	ON	×	○ (1080i ~ 480p)	×	○				○ (COMPONENT)	×	
12	ON	×	○ (480i/576i)	×	○	COMPONENT				×	
13	ON	×	○ (1080p)	○	×					×	
14	ON *1	×	○ (1080p)	○	×	-			-	○ (S-VIDEO)	
15	ON	×	○ (1080i ~ 480p)	○	×					×	
16	ON	×	○ (480i/576i)	○	×	COMPONENT		S-VIDEO	○ (COMPONENT)	×	×
17	ON	×	○ (1080p)	○	○					×	
18	ON *1	×	○ (1080p)	○	×	-			-	○ (S-VIDEO)	
19	ON	×	○ (1080i ~ 480p)	○	○	COMPONENT			○ (COMPONENT)	×	
20	ON	×	○ (480i/576i)	○	○					×	
21	ON	○	×	×	×		×	×			×
22	ON	○	×	×	○		×	VIDEO		×	×
23	ON	○	×	○	×		×	S-VIDEO		×	×
24	ON	○	×	○	○		×				×
25	ON	○	○	×	×			×			×
26	ON	○	○	×	○			VIDEO		×	×
27	ON	○	○	○	×			S-VIDEO		×	×
28	ON	○	○	○	○						
29	OFF	×	×	×	○	×	×	VIDEO		×	×
30	OFF	×	×	○	×	×	×	S-VIDEO		×	×
31	OFF	×	×	○	○	×	×				
32	OFF	×	○	×	×			×			×
33	OFF	×	○	×	○			VIDEO		×	×
34	OFF	×	○	○	×			S-VIDEO		×	×
35	OFF	×	○	○	○	×	×				
36	OFF	○	×	×	×			×			×
37	OFF	○	×	×	○			VIDEO		×	×
38	OFF	○	×	○	×			S-VIDEO		×	×
39	OFF	○	×	○	○			×			
40	OFF	○	○	×	×			×			×
41	OFF	○	○	×	○			VIDEO		×	×
42	OFF	○	○	○	×			S-VIDEO		×	×
43	OFF	○	○	○	○						

○ Video signal input present
 × No video signal input

*1 When no HDMI monitor is connected or the HDMI monitor's power is not on

× No video signal output

○ () Superimposed on the picture indicated in ().

× () Only the picture in () is output.

× Neither the picture nor the menu is output.

*2 Only the menu is displayed when no HDMI monitor is connected or the HDMI monitor's power is not on.

*3 If an HDMI monitor is not connected or power of an HDMI monitor is not turned on, the menu is superimposed on a video image in parenthesis.

NOTE

- If you operate the menu while playing back 3D video content, the playback video is replaced by the menu screen. The playback video is not displayed behind the menu screen.
- This unit does not show the status display while playing back 3D video content.

ZONE2 MONITOR OUT			
	Input Signals		Output Signals
	S-VIDEO	VIDEO	VIDEO
1	×	×	×
2	×	○	VIDEO
3	○	×	S-VIDEO
4	○	○	S-VIDEO



- The main zone video conversion function is compatible with the following formats: NTSC, PAL, SECAM, NTSC4.43, PAL-N, PAL-M and PAL-60.
- When SECAM signals of video input are up-converted, the signals are output in PAL format from the S-Video and Video connectors.
- The menu display cannot be superimposed when x.v.Color signals and computer's resolution (e.g. VGA) are input.

Simple version

Basic version

Advanced version

Information

Explanation of terms

A

Adobe RGB color, Adobe YCC601 color

Like x.v.Color, each of these color spaces defines a palette of available colors that is larger than the traditional RGB color model.

AL24 Processing Plus

AL24 Processing for All Channels

DENON has further developed its proprietary AL24 Processing, an analog waveform reproduction technology, to support the 192 kHz sampling frequency. AL24 Processing Plus, thoroughly suppresses quantization noise associated with D/A conversion of LPCM signals to reproduce the low-level signals with optimum clarity that will bring out all the delicate nuances of the music.

Equipped for not only front left and right channels but also for the surround left and right, center and subwoofer channels.

Audyssey Dynamic Surround Expansion™

(A-DSX)

Realistic reproduction of sound relies on the ability of audio systems to match human hearing performance. Three key requirements are: (1) frequency response, (2) dynamic range, and (3) accurate spatial reproduction. The requirements for frequency response have already been surpassed with sampling rates that exceed human hearing. The dynamic range limits of human perception have also been met with current digital audio systems operating capable of signal to noise ratios that approach 120 dB. Accurate spatial sound rendering, however, has not yet reached the limits of perception as human perception relies on the combination of sounds arriving from many more directions than what 5.1-channel surround sound systems provide. Audyssey DSX technology was developed to overcome the spatial sound rendering limitations faced by 5.1-channel surround sound formats.

The ITU 5.1-channel standard recommends three front loudspeakers and two rear loudspeakers. The Left (L) and Right (R) front loudspeakers should be placed at $\pm 30^\circ$ relative to the central listening position. The Center (C) loudspeaker should be at 0° and the surround loudspeakers (SL, SR) should be placed between 100° and 120° . All loudspeakers must be equidistant from the center listening position or compensated with time delay if that is not possible. A separate low-frequency effects (LFE) channel is used to reproduce additional bass

content from the subwoofer.

There are certain things that 5.1-channel surround sound systems do well compared to 2-channel stereo. For example, it is possible to move sounds across the front seamlessly. It is also possible to create ambience behind the listener. But 5.1 channel surround systems do not provide enough channels from which to render the required reflected sound components for a seamless and enveloping soundstage. Unfortunately, the additional two back surround channels in 7.1-channel systems are not in the right place to provide a significant perceptual improvement.

Adding more channels to a surround system is not for special effects. Accurate spatial sound reproduction requires rendering of directional sound cues and non-directional ambient cues. Reflections arriving after the direct sound play a critical role in the perception of soundstage width and depth. To have the most impact, additional surround channels should be used to control the direction, time of arrival, and frequency response of the reflected sound to render an expanded soundstage that reproduces sound with better localization and envelopment than what 5.1-channel systems provide.

Research in the perception of auditory source width has shown that there are strong preferences in the direction of reflected sound and the perception of soundstage width and spaciousness. The single most important direction of side-wall reflections is $\pm 60^\circ$. DSX provides a pair of Wide channels (LW and RW) at $\pm 60^\circ$ with appropriate frequency response and perceptual processing to match the requirements of human hearing. In fact, the Wide channels are much more critical in the presentation of a realistic soundstage than then Back Surround channels found in traditional 7.1-channel systems. A more enveloping 7.1-channel system is one in which Wide speakers are used instead of Back Surround speakers. Adding surround channels behind the listener has a very small impact compared to the increase in envelopment and soundstage width that the front wide channels will provide.

After side reflections, the next most important acoustical and perceptual cues come from reflections above the front stage. DSX provides a pair of Height channels (LH and RH) at a $\pm 45^\circ$ azimuth angle and elevated to a 45° angle in the median plane.

In addition to creating new Wide and Height channels, DSX also provides Surround Processing to enhance the envelopment of the Surround and Back Surround channels (if present). DSX Surround Processing processes the standard surround signals in the time and frequency domains to improve the perceived sense of envelopment and blending with the other speakers in the surround system.

Audyssey Dynamic Surround Expansion is a scalable system that can adapt to the practical needs of the user. The first level of surround stage enhancement comes from adding the Wide channels. The second level comes from adding the Height channels. If it is practical to have both Wides and Heights then the surround performance will be further enhanced. DSX automatically reconfigures its processing to optimize surround rendering over any number of available speakers beyond that of 5.1-channel.

Audyssey Dynamic EQ®

Audyssey Dynamic EQ solves the problem of deteriorating sound quality as volume is decreased by taking into account human perception and room acoustics. Audyssey Dynamic EQ works in tandem with Audyssey MultEQ XT to provide well-balanced sound for every listener at any volume level.

Audyssey Dynamic Volume®

Audyssey Dynamic Volume solves the problem of large variations in volume level between television programs, commercials, and between the soft and loud passages of movies. Audyssey Dynamic EQ is integrated into Dynamic Volume so that as the playback volume is adjusted automatically, the perceived bass response, tonal balance, surround impression, and dialog clarity remain the same.

Audyssey MultEQ® XT

Audyssey MultEQ XT is a room equalization solution that calibrates any audio system so that it can achieve optimum performance for every listener in a large listening area. Based on several room measurements, MultEQ XT calculates an equalization solution that corrects for both time and frequency response problems in the listening area and also performs a fully automated surround system setup.

Auto Lip Sync

If you connect the receiver to a TV that supports the Auto Lip Sync function, it can automatically correct delay between the audio and video.

D

Deep Color

This technology allows expression of more number of colors than the conventional 8 bits and can reproduce colors close to natural ones without color streak.

DLNA

DLNA and DLNA CERTIFIED are trademarks and/or service marks of Digital Living Network Alliance. Some contents may not be compatible with other DLNA CERTIFIED™ products.

Dolby Digital

Dolby Digital is a multi-channel digital signal format developed by Dolby Laboratories.

A total of 5.1 channels are played: 3 front channels ("FL", "FR" and "C"), 2 surround channels ("SL" and "SR") and the "LFE" channel for low frequencies.

Because of this, there is no crosstalk between channels and a realistic sound field with a "three-dimensional" feeling (sense of distance, movement and positioning) is achieved.

A realistic, powerful sense of presence is achieved when playing movie sources in AV rooms as well.

Dolby Digital EX

Dolby Digital EX is a 6.1-channel surround format proposed by Dolby Laboratories that allows users to enjoy in their homes the "DOLBY DIGITAL SURROUND EX" audio format jointly developed by Dolby Laboratories and Lucas Films.

The 6.1 channels of sound, including surround back channels, provide improved sound positioning and expression of space.

Dolby Digital Plus

Dolby Digital Plus is an improved Dolby Digital signal format that is compatible with up to 7.1 channels of discrete digital sound and also improves sound quality thanks to extra data bit rate performance. It is upwardly compatible with conventional Dolby Digital, so it offers greater flexibility in response to the source signal and the conditions of the playback equipment.

Dolby TrueHD

Dolby TrueHD is a high definition audio technology developed by Dolby Laboratories, using lossless coding technology to faithfully reproduce the sound of the studio master.

This format provides the facility to support up to 8 audio channels with a sampling frequency of 96kHz/24bit resolution and up to 6 audio channels with a sampling frequency of 192kHz/24bit resolution. Dolby TrueHD is adopted for applications that put very high importance on sound quality.

Dolby Pro Logic II

Dolby Pro Logic II is a matrix decoding technology developed by Dolby Laboratories.

Regular music such as that on CDs is encoded into 5 channels to achieve an excellent surround effect. The surround channel signals are converted into stereo and full band signals (with a frequency response of 20 Hz to 20 kHz or greater) to create a "three-dimensional" sound image offering a rich sense of presence for all stereo sources.

Dolby Pro Logic IIx

Dolby Pro Logic IIx is a further improved version of the Dolby Pro Logic II matrix decoding technology. Audio signals recorded in 2 channels are decoded to achieve a natural sound with up to 7.1 channels. There are three modes: "Music" suited for playing music, "Cinema" suited for playing movies, and "Game" which is optimized for playing games.

Dolby Pro Logic IIz

Dolby Pro Logic IIz introduces a new dimension to Home Entertainment through the addition of a pair of front height channels. Compatible with stereo, 5.1-channel and 7.1-channel content, Dolby Pro Logic IIz provides enhanced spaciousness, depth and dimension to movies, concert video and video game playback while maintaining the full integrity of the source mix.

Dolby Pro Logic IIz identifies and decodes spatial cues that occur naturally in all content, directing this information to the front height channels, complementing the performance of left and right surround sound speakers. Content that is encoded with Dolby Pro Logic IIz height channel information can be even more revealing, with perceptually discrete height channel information bringing an exciting new dimension to home entertainment.

Dolby Pro Logic IIz, with front height channels is also an ideal alternative for households that cannot support the placement of back surround speakers of a typical 7.1-channel system but may have bookshelf space available to support the addition of height speakers.

Downmix

This function converts the number of channels of surround audio to less number of channels and plays back.

DTS

This is an abbreviation of Digital Theater System, which is a digital audio system developed by DTS. When playing back audio by connecting this system with a device such as DTS amplifier, accurate sound field position and realistic sound effect as if you are in a movie theater can be obtained.

DTS 96/24

DTS 96/24 is a digital audio format enabling high sound quality playback in 5.1 channels with a sampling frequency of 96 kHz and 24 bit quantization on DVD-Video.

DTS Digital Surround

DTS Digital Surround is the standard digital surround format of DTS, Inc., compatible with a sampling frequency of 44.1 or 48 kHz and up to 5.1 channels of digital discrete surround sound.

DTS-ES™ Discrete 6.1

DTS-ES™ Discrete 6.1 is a 6.1-channel discrete digital audio format adding a surround back (SB) channel to the DTS digital surround sound. Decoding of conventional 5.1-channel audio signals is also possible according to the decoder.

DTS-ES™ Matrix 6.1

DTS-ES™ Matrix 6.1 is a 6.1-channel discrete digital audio format inserting a surround back (SB) channel to the DTS digital surround sound through matrix encoding. Decoding of conventional 5.1-channel audio signals is also possible according to the decoder.

DTS Express

DTS Express is an audio format supporting low bit rates (max. 5.1 channels, 24 to 256 kbps).

DTS-HD

This audio technology provides higher sound quality and enhanced functionality than the conventional DTS and is adopted as an optional audio for Blu-ray Disc. This technology supports multi-channel, high data transfer speed, high sampling frequency, and lossless audio playback. Maximum 7.1-channels are supported in Blu-ray Disc.

DTS-HD High Resolution Audio

DTS-HD High Resolution Audio is an improved version of the conventional DTS, DTS-ES and DTS 96/24 signals formats, compatible with sampling frequencies of 96 or 48 kHz and up to 7.1 channels of discrete digital sound. High data

bit rate performance provides high quality sound. This format is fully compatible with conventional products, including conventional DTS digital surround 5.1-channel data.

DTS-HD Master Audio

DTS-HD Master Audio is a lossless audio format created by Digital Theater System (DTS). This format provides the facility to support up to 8 audio channels with a sampling frequency of 96kHz/24bit resolution and up to 6 audio channels with a sampling frequency of 192kHz/24bit resolution. It is fully compatible with conventional products, including conventional DTS digital surround 5.1-channel data.

DTS NEO:6™ Surround

DTS NEO:6™ is a matrix decoding technology for achieving 6.1-channel surround playback with 2-channel sources. It includes "DTS NEO:6 Cinema" suited for playing movies and "DTS NEO:6 Music" suited for playing music.

Dynamic range

The difference between the maximum undistorted sound level and the minimum discernible level above the noise emitted by the device.

H**HDCP**

When transmitting digital signals between devices, this copyright protection technology encrypts the signals to prevent content from being copied without authorization.

HDMI

This is an abbreviation of High-Definition Multimedia Interface, which is an AV digital interface that can be connected to a TV or amplifier. Video signal and audio signal can be connected using 1 cable.

L**LFE**

This is an abbreviation of Low Frequency Effect, which is an output channel that emphasizes low frequency effect sound. Surround audio is intensified by outputting 20 Hz to 120 Hz deep bass.

M**MAIN ZONE**

The room where this unit is placed is called the MAIN ZONE.

MP3 (MPEG Audio Layer-3)

This is an internationally standardized audio data compression scheme, using the "MPEG-1" video

compression standard. It compresses the data volume to about one eleventh its original size while maintaining sound quality equivalent to a music CD.

MPEG (Moving Picture Experts Group), MPEG-2, MPEG-4

These are the names for digital compression format standards used for the encoding of video and audio. Video standards include "MPEG-1 Video", "MPEG-2 Video", "MPEG-4 Visual", "MPEG-4 AVC". Audio standards include "MPEG-1 Audio", "MPEG-2 Audio", "MPEG-4 AAC".

P**Progressive (sequential scanning)**

This is a scanning system of video signal that displays 1 frame of video as one image. Compared to the interlace system, this system provides images with less flickering and bleeding.

Protection Circuit

This is a function to prevent damage to components within the power supply when an abnormality such as an overload, excess voltage occurs or temperature for any reason.

In this unit, the power indicator blinks and the unit enters standby mode when an abnormality occurs.

S**Sampling frequency**

Sampling involves taking a reading of a sound wave (analog signal) at regular intervals and expressing the height of the wave at each reading in digitized format (producing a digital signal).

The number of readings taken in one second is called the "sampling frequency". The larger the value, the closer the reproduced sound is to the original.

Speaker impedance

This is an AC resistance value, indicated in Ω (ohms). Greater power can be obtained with this value smaller.

sYCC601 color

Like x.v.Color, each of these color spaces defines a palette of available colors that is larger than the traditional RGB color model.

Explanation of terms

V

vTuner

This is a free online content server for Internet radio. Note that usage fees are included in upgrade costs.

For inquiries about this service, visit the vTuner site below.

vTuner website: <http://www.radiodenon.com>

This product is protected by certain intellectual property rights of Nothing Else Matters Software and BridgeCo. Use or distribution of such technology outside of this product is prohibited without a license from Nothing Else Matters Software and BridgeCo or an authorized subsidiary.

W

Windows Media DRM

This is a copyright protection technology developed by Microsoft.

Content providers are using the digital rights management technology for Windows Media contained in this device (WM-DRM) to protect the integrity of their content (Secure Content) so that their intellectual property, including copyright, in such content is not misappropriated. This device uses WM-DRM software to play Secure Content (WM-DRM Software). If the security of the WM-DRM Software in this device has been compromised, owners of Secure Content (Secure Content Owners) may request that Microsoft revoke the WM-DRM Software's right to acquire new licenses to copy, display and/or play Secure Content. Revocation does not alter the WM-DRM Software's ability to play unprotected content. A list of revoked WM-DRM Software is sent to your device whenever you download a license for Secure Content from the Internet or from a PC. Microsoft may, in conjunction with such license, also download revocation list onto your device on behalf of Secure Content Owners.

Windows Media Player Ver.11

This is a media player distributed free of charge by Microsoft Corporation.

It can be used to play playlists created with Windows Media Player Ver. 11 as well as files in such formats as WMA, DRM WMA, MP3 and WAV.

WMA (Windows Media Audio)

This is audio compression technology developed by Microsoft Corporation.

WMA data can be encoded using Windows Media® Player Ver.7, 7.1, Windows Media®Player for Windows® XP and Windows Media® Player 9 Series.

To encode WMA files, only use applications authorized by Microsoft Corporation. If you use an unauthorized application, the file may not work properly.

X

x.v.Color

This function lets HDTVs display colors more accurately. It enables display with natural, vivid colors. "x.v.Color" is a Sony registered trademark.

Z

ZONE2

This unit can operate in a room other than the room where this unit is placed (MAIN ZONE) (ZONE2 playback). The room for ZONE2 playback is called ZONE2.

ZONE3

This unit can operate in a room other than the room where this unit is placed (MAIN ZONE) (ZONE3 playback). The room for ZONE3 playback is called ZONE3.

Troubleshooting

If a problem should arise, first check the following:

1. Are the connections correct?

2. Is the set being operated as described in the owner's manual?

3. Are the other components operating properly?

If this unit does not operate properly, check the items listed in the table below. Should the problem persist, there may be a malfunction.

In this case, disconnect the power immediately and contact your store of purchase.

[General]

Symptom	Cause/Solution	Page
Power does not turn on.	• Check whether the power plug is correctly inserted into the power outlet.	5
	• The protection circuit is active. Disconnect the power plug from the electric outlet, wait 5 to 10 seconds and then insert it back into the outlet.	4, 107
Display is off.	• Set "Dimmer" on the menu to something other than "OFF".	84
The power indicator is blinking red in intervals of approximately 2 seconds.	• The temperature inside the unit has risen. Please turn off power once, and re-apply the power after the temperature has fallen sufficiently.	–
	• Please re-install this unit in a place having good ventilation.	–
The power indicator is blinking red in intervals of approximately 0.5 seconds.	• Please use speakers which have the specified impedance.	4
	• The speaker cable has shorted (is touching). Firmly twist the core wire in the speaker cable, and then re-connect it to the speaker terminal.	4
After turning on the power, the power indicator is blinking red in intervals of approximately 0.5 seconds.	• This unit amplifier circuit has failed. Turn off the power and please contact the DENON service adviser.	–
Set does not operate properly.	• Reset the microprocessor.	111

[Video]

Symptom	Cause/Solution	Page
No picture appears.	• Check the TV connection.	5
	• Set the TV input correctly.	6

[Audio]

Symptom	Cause/Solution	Page
Audio is not output.	<ul style="list-style-type: none"> • Check the connections for all devices. • Check the speaker connections. • Check whether the audio device power is turned on. • Adjust the master volume. • Cancel the mute mode. • Select a suitable input source. • Select a suitable input mode. • Disconnect the headphones. No sound is output from the speakers or the PRE OUT connectors when headphones are connected. 	5, 14 – 23 5, 45 – 48 – 24, 58 25, 58 24, 58 67 95
No sound is produced from surround speaker.	<ul style="list-style-type: none"> • Check if the surround speakers are connected to the SURROUND terminals. 	–
No sound is produced from surround back speaker.	<ul style="list-style-type: none"> • Set “Amp Assign” on the menu to “Normal”. • Set “Speaker Config.” – “S.Back” on the menu to something other than “None”. • Set “Surround Parameter” – “S.Back” on the menu to something other than “OFF”. • Set the surround mode to something other than “STEREO”. 	75 75 70 42
No sound is produced from front height speaker.	<ul style="list-style-type: none"> • Set “Surround Parameter” – “F.Height” on the menu to “ON”. • Set “Amp Assign” on the menu to “Normal”. • Set “Speaker Config.” – “Surround” on the menu to something other than “None”. 	69 75 75
No sound is produced from subwoofer.	<ul style="list-style-type: none"> • Check the subwoofer connections. • Turn on the subwoofer’s power. • Set “Speaker Config.” – “Subwoofer” on the menu to “Yes”. • If “Front” and “Center” for “Speaker Config.” are set to “Large”, and “Subwoofer Mode” is set to “LFE”, no sound may be output from the subwoofers, depending on the input signal or selected surround mode. 	5, 45 – 48 6 75 75
DTS sound is not output.	<ul style="list-style-type: none"> • Set “Decode Mode” on the menu to “Auto” or “DTS”. 	67
Dolby TrueHD, DTS-HD, Dolby Digital Plus audio is not output.	<ul style="list-style-type: none"> • Make HDMI connections. 	14

[HDMI]

Symptom	Cause/Solution	Page
No audio is output with HDMI connection.	<ul style="list-style-type: none"> • Check the connection of the HDMI connectors. • When outputting HDMI audio from the speakers, set “HDMI Audio Out” on the menu to “AMP”. • When outputting HDMI audio from a TV, set “HDMI Audio Out” on the menu to “TV”. 	14 77 77
No video is output with HDMI connection.	<ul style="list-style-type: none"> • Check the connection of the HDMI connectors. • Set the input source to match the connected HDMI connector. • Check whether the TV is compatible with copyright protection (HDCP). If connected to a device not compatible with HDCP, video will not be output correctly. 	14 14, 24 14
When the following operations are performed on devices compatible with HDMI control, the same operations occur on this unit.	<ul style="list-style-type: none"> • Set “HDMI Control” on the menu to “OFF”. To operate power only for each device, set “Power Off Control” to “OFF”. 	50, 78
<ul style="list-style-type: none"> • Power ON/OFF • Switching audio output devices • Adjust volume • Switch input source 		

[Radio]

Symptom	Cause/Solution	Page
Reception fails, or there is a lot of noise or distortion.	<ul style="list-style-type: none"> • Change the antenna orientation or position. • Separate the AM loop antenna from the unit. • Use an FM outdoor antenna. • Separate the antenna from other connection cables. 	20 20 20 20

[Control dock for iPod]

Symptom	Cause/Solution	Page
iPod cannot be played.	<ul style="list-style-type: none"> • Check the iPod connections. • Plug the control dock for iPod’s AC adapter into a power outlet. • Switch the input source to “DOCK”. 	19 – 24

[Internet radio / Media server / iPod / USB memory device / Flickr / Napster / Last.fm]

Symptom	Cause/Solution	Page
When a USB memory device is connected, "USB" is not displayed on the menu.	• The set cannot recognize a USB memory device. Check the connection.	19
	• A USB memory device not conforming to mass storage class or MTP standards is connected. Connect a USB memory device conforming to mass storage class or MTP standards.	-
	• A USB memory device that the set cannot recognize is connected. This is not a malfunction. DENON does not guarantee that all USB memory devices will operate or receive power.	-
	• USB memory device is connected via USB hub. Connect the USB memory device directly to the USB port.	-
Files on a USB memory device cannot be played.	• USB memory device is in format other than FAT16 or FAT32. Set the format to FAT16 or FAT32. For details, refer to the USB memory device's operating instructions.	-
	• USB memory device is divided into multiple partitions. When divided into multiple partitions, only files stored in the top partition can be played.	-
	• Files are stored in a non-compatible format. Record the files in a compatible format.	30, 31
	• You are attempting to play a file that is copyright protected. Files that are copyright protected cannot be played on this set.	30, 31
The file names are not displayed properly ("...", etc.).	• Characters that cannot be displayed are used. This is not a malfunction. On this set, characters that cannot be displayed are replaced with a "." (period).	-
Internet radio cannot be played.	• Ethernet cable is not properly connected or network is disconnected. Check the connection status.	22
	• Program is being broadcast in non-compatible format. Only Internet radio programs in MP3 and WMA can be played on this set.	30, 31
	• The computer's or router's firewall is activated. Check the computer's or router's firewall settings.	-
	• Radio station is not currently broadcasting. Choose a radio station that is currently broadcasting.	32, 33
	• IP address is wrong. Check the set's IP address.	81
Files stored on a computer cannot be played.	• Files are stored in a non-compatible format. Record in a compatible format.	30, 31
	• You are attempting to play a file that is copyright protected. Files that are copyright protected cannot be played on this set.	30
	• Set and computer are connected by USB cable. The set's USB port cannot be used for connection to a computer.	-
Server is not found, or it is not possible to connect to the server.	• The computer's or router's firewall is activated. Check the computer's or router's firewall settings.	-
	• Computer's power is not turned on. Turn on the power.	-
	• Server is not running. Launch the server.	-
	• Set's IP address is wrong. Check the set's IP address.	81

Symptom	Cause/Solution	Page
iPod cannot be played.	• Some iPods do not support being used connected directly to the USB port.	19
Cannot connect to preset or favorite radio stations.	• Radio station is not currently broadcasting. Wait a while before trying again.	-
	• Radio station is not currently in service. It is not possible to connect to radio stations that are no longer in service.	-
For some radio stations, "Server Full" or "Connection Down" is displayed and station cannot be connected to.	• Station is congested or not currently broadcasting. Wait a while before trying again.	-
Sound is broken during playback.	• Network's signal transfer speed is slow or communications lines or radio station is congested. This is not a malfunction. When playing broadcast data with a high bit rate, the sound may be broken, depending on the communications conditions.	-
Sound quality is poor or played sound is noisy.	• File being played has a low bit rate. This is not a malfunction.	-
Cannot compile Playlist.	• This unit does not respond to playlist compilation. When the playlist is compiled in PC Application, it is registered to "My Library". In this way, the playlist can be played in this unit	-
Cannot delete Tracks, Playlists, Channels registered in "My Library"	• Cannot be done with this unit. Delete from PC Application.	-
Cannot login to Napster. ("Incorrect Username or Password" is displayed.)	• Login information is incorrect. Check if the Username for Napster has been properly entered. Re-enter the Password. (Password is not displayed.) http://www.napster.com/choose/index_default.html	81

[Remote Control Unit]

Symptom	Cause/Solution	Page
The set cannot be operated with the remote control unit.	• Batteries are worn out. Replace with new batteries.	99
	• Operate the remote control unit within a distance of about 7 m from this unit and at an angle of within 30°.	99
	• Remove any obstacle between this unit and the remote control unit.	99
	• Insert the batteries in the proper direction, checking the ⊕ and ⊖ marks.	99
	• The set's remote control sensor is exposed to strong light (direct sunlight, inverter type fluorescent bulb light, etc.). Move the set to a place in which the remote control sensor will not be exposed to strong light.	99

Resetting the microprocessor

Perform this procedure if the display is abnormal or if operations cannot be performed. When the microprocessor is reset, all the settings are reset to their default values.

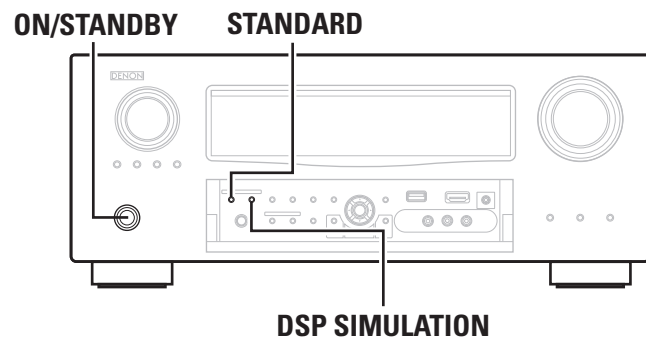

- 1** Turn off the power using **ON/STANDBY**.
- 2** Press **ON/STANDBY** while simultaneously pressing **STANDARD** and **DSP SIMULATION**.
- 3** Once the display starts flashing at intervals of about 1 second, release the two buttons.



If in step 3 the display does not flash at intervals of about 1 second, start over from step 1.

Specifications

□ Audio section

• Power amplifier

Rated output:	Front: 125 W + 125 W (8 Ω, 20 Hz – 20 kHz with 0.05 % T.H.D.) 165 W + 165 W (6 Ω, 1 kHz with 0.7 % T.H.D.)
	Center: 125 W (8 Ω, 20 Hz – 20 kHz with 0.05 % T.H.D.) 165 W (6 Ω, 1 kHz with 0.7 % T.H.D.)
	Surround: 125 W + 125 W (8 Ω, 20 Hz – 20 kHz with 0.05 % T.H.D.) 165 W + 165 W (6 Ω, 1 kHz with 0.7 % T.H.D.)
	Surround back / Front height / Front wide: 125 W + 125 W (8 Ω, 20 Hz – 20 kHz with 0.05 % T.H.D.) 165 W + 165 W (6 Ω, 1 kHz with 0.7 % T.H.D.)

Dynamic power:	130 W x 2ch (8 Ω) 190 W x 2ch (4 Ω)
-----------------------	--

Output connectors:	6 – 16 Ω
---------------------------	----------

• Analog

Input sensitivity/Input impedance:	200 mV/47 kΩ
Frequency response:	10 Hz – 100 kHz — +1, –3 dB (DIRECT mode)
S/N:	102 dB (IHF–A weighted, DIRECT mode)
Distortion:	0.005 % (20 Hz ~ 20 kHz) (DIRECT mode)
Rated output:	1.2 V

• Digital

D/A output:	Rated output — 2 V (at 0 dB playback) Total harmonic distortion — 0.008 % (1 kHz, at 0 dB) S/N ratio — 102 dB Dynamic range — 100 dB Format — Digital audio interface
--------------------	---

Digital input:

• Phono equalizer (PHONO input – REC OUT)

Input sensitivity:	2.5 mV
RIAA deviation:	±1 dB (20 Hz to 20 kHz)
S/N:	74 dB (A weighting, with 5 mV input)
Rated output:	150 mV
Distortion factor:	0.03 % (1 kHz, 3 V)

□ Video section

• Standard video connectors

Input/output level and impedance:	1 Vp-p, 75 Ω
Frequency response:	5 Hz – 10 MHz — +1, –3 dB

• Color component video connector

Input/output level and impedance:	Y (brightness) signal — 1 Vp-p, 75 Ω P _B / C _B signal — 0.7 Vp-p, 75 Ω P _R / C _R signal — 0.7 Vp-p, 75 Ω
Frequency response:	5 Hz – 60 MHz — +0, –3 dB (when “Video Convert” set to “OFF”)

□ Tuner section

	[FM]	[AM]
Receiving Range:	87.5 MHz – 108.0 MHz	522 kHz – 1611 kHz
Usable Sensitivity:	1.2 μV (12.8 dBf)	18 μV
50 dB Quieting Sensitivity:	MONO 2.0 μV (17.3 dBf) STEREO 42 μV (34.5 dBf)	
S/N (IHF-A):	MONO 72 dB STEREO 67 dB	
Total harmonic Distortion (at 1 kHz):	MONO 0.3 % STEREO 0.7 %	

(Note: μV at 75 Ω, 0 dBf = 1 x 10⁻¹⁵ W)

□ General

Power supply:	AC 230 V, 50 Hz
Power consumption:	670 W 0.1 W (Standby) 2.2 W (CEC standby)
Maximum external dimensions:	434 (W) x 171 (H) x 381 (D) mm
Weight:	12.2 kg

□ Main remote control unit (RC-1146)

Batteries:	R6/AA Type (two batteries)
Maximum external dimensions:	53 (W) x 224 (H) x 28 (D) mm
Weight:	160 g (including batteries)

□ Sub remote control unit (RC-1148)

Batteries:	R03/AAA Type (two batteries)
Maximum external dimensions:	49 (W) x 220 (H) x 24.5 (D) mm
Weight:	114 g (including batteries)

For purposes of improvement, specifications and design are subject to change without notice.

Index

 Numerics

2.1-channel	47
2ch Direct/Stereo	78
3D	14
5.1-channel	45, 46
6.1-channel	44, 46
7.1-channel	4, 44, 45

 A

Accessories	1
Add New Feature	84
Adjust CH	73
Adjusting the master volume	24
Adobe RGB color / Adobe YCC601 color	106
A-DSX Soundstage	72
AFDM	70
AL24 Processing Plus	106
AM loop antenna	20
Amp Assign	75
ARC	14
Aspect	66
Audio Adjust	69
Audio cable	5, 16, 17, 18, 20, 21
Audio Delay	73
Audio Setup	78
Audio/Video Adjust	68
Audyssey Auto Setup	6, 48
Audyssey DSX	72
Audyssey Dynamic EQ	71, 106
Audyssey Dynamic Surround Expansion™ (A-DSX)	106
Audyssey Dynamic Volume	72, 106
Audyssey MultEQ XT	71, 96, 106
Audyssey Settings	71
Auto Lip Sync	77, 106
Auto Preset	64
Auto Setup	6, 48
Auto Surround Mode	79

 B

Base Curve Copy	73
Bass	71, 81
Bass Setting	76
Bi-amp	47
Brightness	74
Browse mode	25, 27

 C

Cable	
Audio cable	5, 16, 17, 18, 20, 21
Coaxial digital cable	17
Component video cable	16, 17
Ethernet cable	22
HDMI cable	5, 15
Optical cable	16, 18
Speaker cable	5
S-Video cable	18
Video cable	16, 17, 18
Channel	81
Channel Level	51, 76
Characters	61
Chroma Level	74
C.Image	69
Cinema EQ	69
Coaxial digital cable	17
Component video cable	16, 17
Condensation	2
Connection	
Antenna	20
Blu-ray Disc player	5, 15, 16
Cable TV	17
CD player	21
Control dock for iPod	19
Digital camcorder	15, 18
Digital video recorder	15, 18
DVD player	15, 17
External control device	23
External power amplifier	21
Game console	15
HDMI	14
Home network (LAN)	22
iPod (USB)	19
Power cord	5
Record player	20
Satellite tuner	17
Set-top box	15, 17
Speaker	4, 45
TV	5, 15, 16
USB memory device	19
Contrast	74
Crossover Frequency	77
C.Width	69

 D

D.Comp	69
Decode Mode	67
Deep Color	14, 106
Delay Time	69
DENON original surround mode	42

Dimension	69
Dimmer	84
Direct Play	68
Display	96
Distance	76
DLNA	106
DNR	74
Dolby	
Dolby Digital	41, 106
Dolby Digital EX	41, 106
Dolby Digital Plus	41, 106
Dolby Pro Logic II	107
Dolby Pro Logic IIx	107
Dolby Pro Logic IIz	44, 107
Dolby TrueHD	41, 107
Downmix	107
DRC	69
DTS	41, 107
DTS 96/24	41, 107
DTS-ES Discrete 6.1	41, 107
DTS-ES Matrix 6.1	41, 107
DTS-HD	41, 107
DTS-HD High Resolution Audio	107
DTS-HD Master Audio	107
DTS Digital Surround	107
DTS Express	107
DTS NEO:6™ Surround	40, 107
Dynamic EQ	71
Dynamic range	107
Dynamic Volume	72

 E

Effect Lev.	69
Enhancer	74
EQ Customize	79
Error messages (Auto Setup)	10
Ethernet cable	22

 F

Fader function	51
F.Height	69, 75
Firmware Update	84
Flickr	31, 34
FM indoor antenna	20
Front A/B (connection)	45, 47
Front height speaker	44, 45
Front Panel	95
Front Speaker Setup	77
Front wide speaker	44, 45
F.Wide	76

 G

GUI	82
-----	----

 H

HDCP	14, 107
HDMI	14, 107
HDMI 1.4a	14
HDMI Audio Out	77
HDMI cable	5, 15
HDMI Control	50, 78
HDMI Setup	77
Headphones	95
Height Gain	70
HPF	81
Hue	74

 I

Information	86
Audio Input Signal	86
Auto Surround Mode	86
HDMI Information	86
Preset Channel	86
Quick Select	86
Status	86
Input Assign	64
Input Mode	67
Input Setup	63
Input signal	41, 103
Inputting characters	61
Interval	68
iPod PLAY	28
i/p Scaler	66

 L

Last.fm	37
Level Lch	81
Level Rch	81
LFE	69, 107
Listening mode	40
Listening position	7

 M

Maintenance Mode	84
MAIN ZONE	107
Manual EQ	73
Manual Setup	74
Master volume display	83
Menu map	59
Mode	69
Monitor Out	77
MP3	107
MPEG	107
MultEQ XT	71
Mute Level	82

N

Napster..... 31, 35
 Network Setup 79
 Last.fm Display 81
 Network Connecting 79
 Network Information 81
 Other 80

O

Optical cable 16, 18
 Option Setup 82
 Dimmer 84
 GUI 82
 Quick Select Name 83
 Remote Preset Codes 83
 Setup Lock 84
 Source Delete 82
 Trigger Out 83
 Volume Control 82
 Zone Rename 83

P

Panorama 69
 Parameter Check 10
 Party mode 53
 Picture Adjust 74
 Playback
 Blu-ray Disc player 25
 CD player 25
 Direct 42
 DVD player 25
 Flickr 34
 FM/AM broadcasts 28
 Internet radio 32
 iPod (Control dock for iPod) 25
 iPod (USB) 27
 Last.fm 37
 Media server 33
 MP3 31, 38
 MPEG-4 AAC 31
 Napster 35
 Network audio 30
 Pure direct 42
 Standard 40
 Stereo 42
 USB memory device 38
 WMA 31, 38
 ZONE2 58
 ZONE3 58
 Playback Mode (Control dock for iPod) 67
 Playback Mode (USB) 68
 Power Off Control 78

Power On Level 82
 Preset codes 83, 87
 Preset Name 64
 Preset Skip 64
 Presetting radio stations 28
 Progressive 107
 Progressive Mode 66
 Protection circuit 107
 PTY 29

Q

Quick select 52, 58
 Quick Select Name 83

R

Random 68
 RDS 29
 Rear panel 97
 REC OUT mode 52
 Reference Level Offset 71
 Remote control unit 87, 98
 Inserting the batteries 99
 Operating AV equipment 87
 Operating components 90
 Registering Preset Codes 87
 Remote ID Setup 84
 Remote mode 25, 27
 Remote Preset Codes 83
 Rename 67
 Repeat 67, 68
 Resetting the microprocessor 111
 Resolution 66
 RESTORER 73
 RGB Range 77
 Room Size 69
 RT 30

S

Sampling frequency 107
 S.Back 70, 75
 Screensaver 82
 Selecting the input source 24
 Setup Lock 84
 Shuffle 67
 Sleep timer 51
 Slide Show 68
 Source Delete 82
 Source Level 67
 Speaker 70
 Connect 4, 45
 Install 4, 44
 Set up 6, 48

Speaker cable 5
 Speaker Config. 75
 Speaker impedance 4, 107
 Speaker Setup 75
 Stage Height 72
 Stage Width 72
 Standby Source 78
 Still Picture 68
 Subwoofer 70
 Subwoofer setting 7
 Surround back speaker 4, 44, 45, 46
 Surround Mode 40, 101
 Surround Parameter 69
 S-Video cable 18
 sYCC601 color 107

T

Tone 70
 Tone Control 70
 TP 30
 Trademark 100
 Treble 71, 81
 Trigger Out 83
 Troubleshooting 108
 Turning off the sound temporarily 25
 Turn off power (standby) 11
 Turn on power 6

V

Video 65
 Video cable 16, 17, 18
 Video conversion 13
 Video Convert 66
 Video Mode 66
 Video Select 65
 Volume Control 82
 Volume Level 82
 Volume Limit 82
 vTuner 108

W

Web control 55
 Windows Media DRM 108
 Windows Media Player Ver.11 108
 Wireless LAN-compatible mobile terminal 54
 WMA 108

X

x.v.Color 14, 108

Z

ZONE2 57, 96, 108
 ZONE3 57, 96, 108
 Zone Rename 83
 Zone Setup 81



DENON

www.denon.com

D&M Holdings Inc.
Printed in China 5411 10430 207D