

DENON®

DCD-900NE
Compact Disc Player

Quick start guide

Before you begin

What's in the box

Quick start guide



Safety Instructions



Warranty
(for North America
model only)



CD player

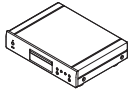

Power cord



Remote control
(RC-1246)



2×R03/AAA batteries



Audio cable



Required for setup

Amplifier

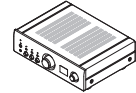

Speakers



Speaker cables



Setup

1

Connect DCD-900NE to the amplifier

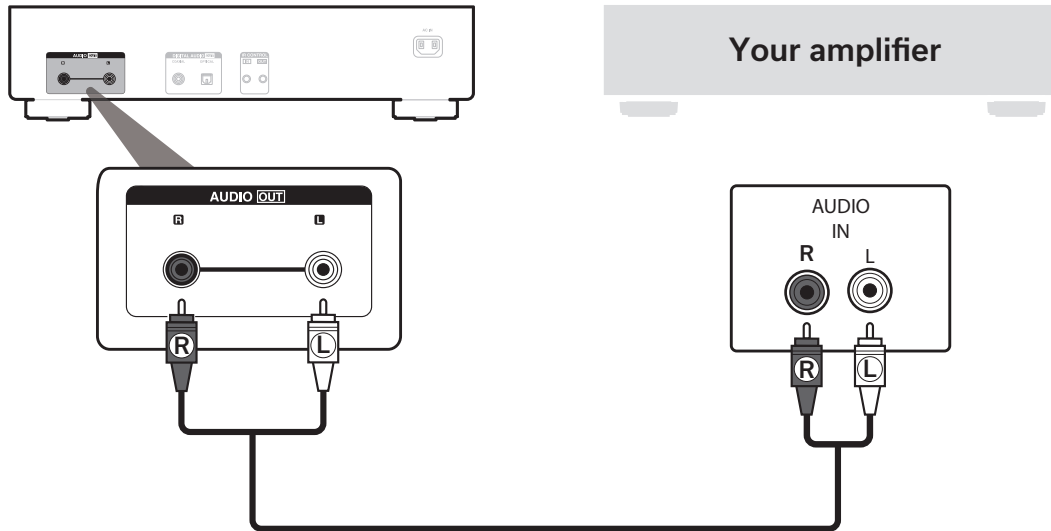

2

Connect to power

Connect the power cord between the DCD-900NE and a wall outlet.

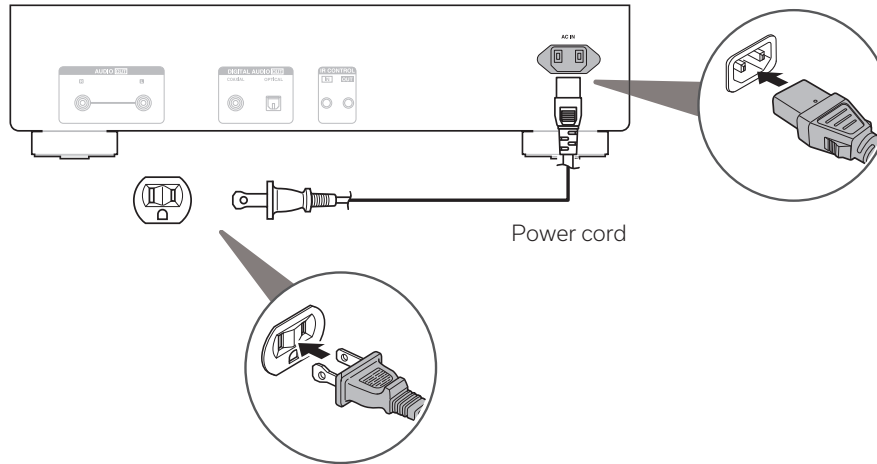

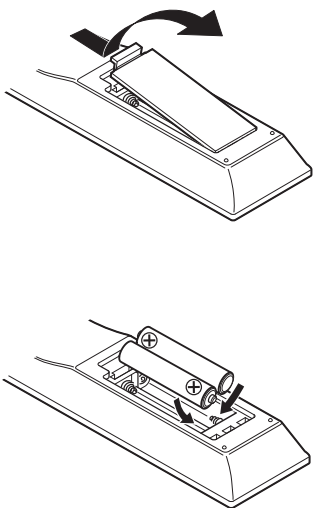
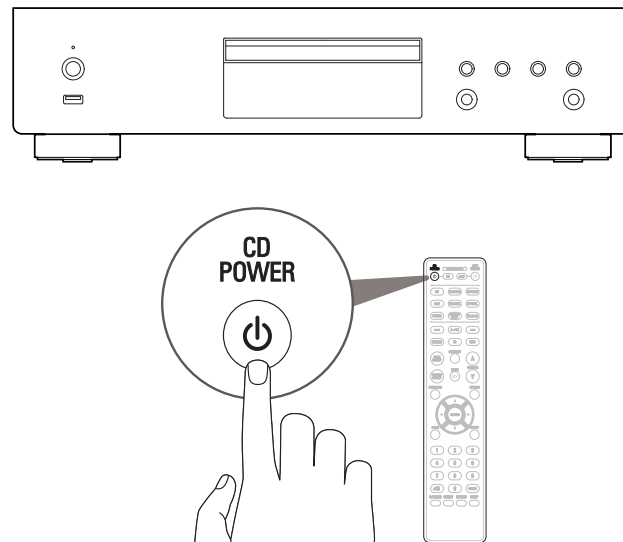
3**Install batteries in the remote control****4****Turn the DCD-900NE's power on**

- Batteries can be taken out in reversed order.

5

Begin CD playback

- 1 Press  to open the disc tray.

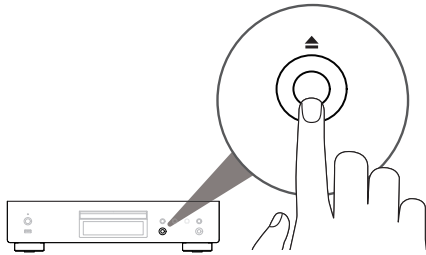

- 2 Place CD in the disc tray.

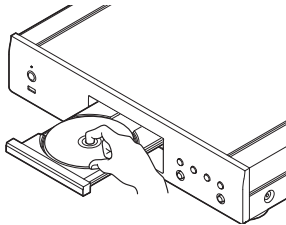

- 3 Press REMOTE MODE CD.
Switch the remote control operating mode to this unit.

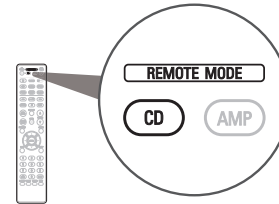

- 4 Press .
Playback starts.

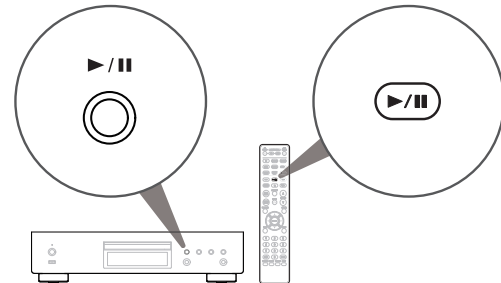

Owner's manual

Refer to the online manual for other functions information and operation procedure details.

manuals.denon.com/DCD900NE/NA/EN/



Online manual

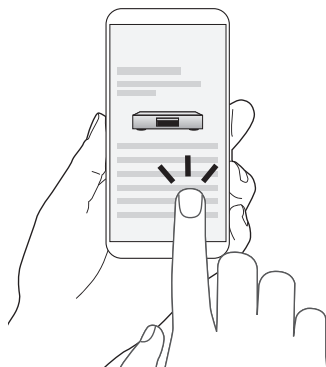

For more information, visit www.denon.com

DENON®

www.denon.com

Printed in Vietnam 5411 11964 00AD
© 2022 Sound United. All Rights Reserved.