

# DENON

AV SURROUND RECEIVER

# AVR-4306

---

OPERATING INSTRUCTIONS

## SAFETY PRECAUTIONS



**CAUTION**

**RISK OF ELECTRIC SHOCK**

**DO NOT OPEN**



**CAUTION:**  
**TO REDUCE THE RISK OF ELECTRIC SHOCK, DO NOT REMOVE COVER (OR BACK). NO USER-SERVICEABLE PARTS INSIDE. REFER SERVICING TO QUALIFIED SERVICE PERSONNEL.**

The lightning flash with arrowhead symbol, within an equilateral triangle, is intended to alert the user to the presence of uninsulated "dangerous voltage" within the product's enclosure that may be of sufficient magnitude to constitute a risk of electric shock to persons.

The exclamation point within an equilateral triangle is intended to alert the user to the presence of important operating and maintenance (servicing) instructions in the literature accompanying the appliance.

**WARNING:**  
**TO REDUCE THE RISK OF FIRE OR ELECTRIC SHOCK, DO NOT EXPOSE THIS APPLIANCE TO RAIN OR MOISTURE.**

## SAFETY INSTRUCTIONS

1. Read Instructions – All the safety and operating instructions should be read before the product is operated.
2. Retain Instructions – The safety and operating instructions should be retained for future reference.
3. Heed Warnings – All warnings on the product and in the operating instructions should be adhered to.
4. Follow Instructions – All operating and use instructions should be followed.
5. Cleaning – Unplug this product from the wall outlet before cleaning. Do not use liquid cleaners or aerosol cleaners.
6. Attachments – Do not use attachments not recommended by the product manufacturer as they may cause hazards.
7. Water and Moisture – Do not use this product near water – for example, near a bath tub, wash bowl, kitchen sink, or laundry tub; in a wet basement; or near a swimming pool; and the like.
8. Accessories – Do not place this product on an unstable cart, stand, tripod, bracket, or table. The product may fall, causing serious injury to a child or adult, and serious damage to the product. Use only with a cart, stand, tripod, bracket, or table recommended by the manufacturer, or sold with the product. Any mounting of the product should follow the manufacturer's instructions, and should use a mounting accessory recommended by the manufacturer.
9. A product and cart combination should be moved with care. Quick stops, excessive force, and uneven surfaces may cause the product and cart combination to overturn.
10. Ventilation – Slots and openings in the cabinet are provided for ventilation and to ensure reliable operation of the product and to protect it from overheating, and these openings must not be blocked or covered. The openings should never be blocked by placing the product on a bed, sofa, rug, or other similar surface. This product should not be placed in a built-in installation such as a bookcase or rack unless proper ventilation is provided or the manufacturer's instructions have been adhered to.
11. Power Sources – This product should be operated only from the type of power source indicated on the marking label. If you are not sure of the type of power supply to your home, consult your product dealer or local power company. For products intended to operate from battery power, or other sources, refer to the operating instructions.
12. Grounding or Polarization – This product may be equipped with a polarized alternating-current line plug (a plug having one blade wider than the other). This plug will fit into the power outlet only one way. This is a safety feature. If you are unable to insert the plug fully into the outlet, try reversing the plug. If the plug should still fail to fit, contact your electrician to replace your obsolete outlet. Do not defeat the safety purpose of the polarized plug.
13. Power-Cord Protection – Power-supply cords should be routed so that they are not likely to be walked on or pinched by items placed upon or against them, paying particular attention to cords at plugs, convenience receptacles, and the point where they exit from the product.
15. Outdoor Antenna Grounding – If an outside antenna or cable system is connected to the product, be sure the antenna or cable system is grounded so as to provide some protection against voltage surges and built-up static charges. Article 810 of the National Electrical Code, ANSI/NFPA 70, provides information with regard to proper grounding of the mast and supporting structure, grounding of the lead-in wire to an antenna discharge unit, size of grounding conductors, location of antenna-discharge unit, connection to grounding electrodes, and requirements for the grounding electrode. See Figure A.
16. Lightning – For added protection for this product during a lightning storm, or when it is left unattended and unused for long periods of time, unplug it from the wall outlet and disconnect the antenna or cable system. This will prevent damage to the product due to lightning and power-line surges.
17. Power Lines – An outside antenna system should not be located in the vicinity of overhead power lines or other electric light or power circuits, or where it can fall into such power lines or circuits. When installing an outside antenna system, extreme care should be taken to keep from touching such power lines or circuits as contact with them might be fatal.
18. Overloading – Do not overload wall outlets, extension cords, or integral convenience receptacles as this can result in a risk of fire or electric shock.
19. Object and Liquid Entry – Never push objects of any kind into this product through openings as they may touch dangerous voltage points or short-out parts that could result in a fire or electric shock. Never spill liquid of any kind on the product.
20. Servicing – Do not attempt to service this product yourself as opening or removing covers may expose you to dangerous voltage or other hazards. Refer all servicing to qualified service personnel.
21. Damage Requiring Service – Unplug this product from the wall outlet and refer servicing to qualified service personnel under the following conditions:
  - a) When the power-supply cord or plug is damaged,
  - b) If liquid has been spilled, or objects have fallen into the product,
  - c) If the product has been exposed to rain or water,
  - d) If the product does not operate normally by following the operating instructions. Adjust only those controls that are covered by the operating instructions as an improper adjustment of other controls may result in damage and will often require extensive work by a qualified technician to restore the product to its normal operation,
  - e) If the product has been dropped or damaged in any way, and
  - f) When the product exhibits a distinct change in performance – this indicates a need for service.

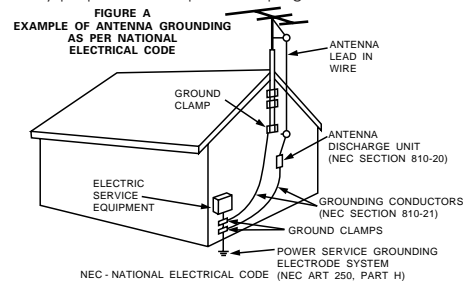

## FCC INFORMATION (For US customers)

### 1. COMPLIANCE INFORMATION

Product Name: AV Surround Receiver  
Model Number: AVR-4306

This product complies with Part 15 of the FCC Rules. Operation is subject to the following two conditions: (1) this product may not cause harmful interference, and (2) this product must accept any interference received, including interference that may cause undesired operation.

Denon Electronics (USA), LLC  
19C Chapin Road, Suite 205  
Pine Brook, NJ 07058-9385  
Tel. 973-396-0810 (Main)

### 2. IMPORTANT NOTICE: DO NOT MODIFY THIS PRODUCT

This product, when installed as indicated in the instructions contained in this manual, meets FCC requirements. Modification not expressly approved by DENON may void your authority, granted by the FCC, to use the product.

### 3. NOTE





This product has been tested and found to comply with the limits for a Class B digital device, pursuant to Part 15 of the FCC Rules. These limits are designed to provide reasonable protection against harmful interference in a residential installation.

This product generates, uses and can radiate radio frequency energy and, if not installed and used in accordance with the instructions, may cause harmful interference to radio communications. However, there is no guarantee that interference will not occur in a particular installation. If this product does cause harmful interference to radio or television reception, which can be determined by turning the product OFF and ON, the user is encouraged to try to correct the interference by one or more of the following measures:

- Reorient or relocate the receiving antenna.
- Increase the separation between the equipment and receiver.
- Connect the product into an outlet on a circuit different from that to which the receiver is connected.
- Consult the local retailer authorized to distribute this type of product or an experienced radio/TV technician for help.

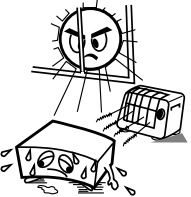
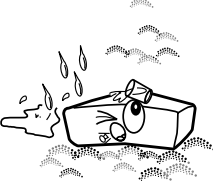
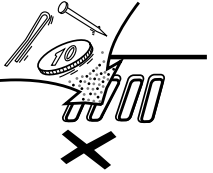
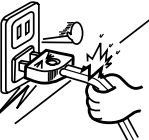
This class B digital apparatus complies with Canadian ICES-003.

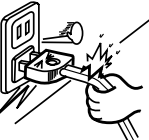
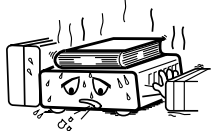
## NOTE ON USE / OBSERVATIONS RELATIVES A L'UTILISATION

 <ul style="list-style-type: none"> <li>• Avoid high temperatures. Allow for sufficient heat dispersion when installed in a rack.</li> <li>• Eviter des températures élevées. Tenir compte d'une dispersion de chaleur suffisante lors de l'installation sur une étagère.</li> </ul>	 <ul style="list-style-type: none"> <li>• Keep the apparatus free from moisture, water, and dust.</li> <li>• Protéger l'appareil contre l'humidité, l'eau et la poussière.</li> </ul>	 <ul style="list-style-type: none"> <li>• Do not let foreign objects into the apparatus.</li> <li>• Ne pas laisser des objets étrangers dans l'appareil.</li> </ul>
 <ul style="list-style-type: none"> <li>• Handle the power cord carefully. Hold the plug when unplugging the cord.</li> <li>• Manipuler le cordon d'alimentation avec précaution. Tenir la prise lors du débranchement du cordon.</li> </ul>	 <ul style="list-style-type: none"> <li>• Unplug the power cord when not using the apparatus for long periods of time.</li> <li>• Débrancher le cordon d'alimentation lorsque l'appareil n'est pas utilisé pendant de longues périodes..</li> </ul>	 <ul style="list-style-type: none"> <li>• Do not let insecticides, benzene, and thinner come in contact with the apparatus.</li> <li>• Ne pas mettre en contact des insecticides, du benzène et un diluant avec l'appareil.</li> </ul>
 <ul style="list-style-type: none"> <li>• Handle the power cord carefully. Hold the plug when unplugging the cord.</li> <li>• Manipuler le cordon d'alimentation avec précaution. Tenir la prise lors du débranchement du cordon.</li> </ul>	 <p>* (For apparatuses with ventilation holes)</p> <ul style="list-style-type: none"> <li>• Do not obstruct the ventilation holes.</li> <li>• Ne pas obstruer les trous d'aération.</li> </ul>	 <ul style="list-style-type: none"> <li>• Never disassemble or modify the apparatus in any way.</li> <li>• Ne jamais démonter ou modifier l'appareil d'une manière ou d'une autre.</li> </ul>

# Getting Started

Thank you for choosing the DENON AVR-4306 AV Surround Receiver. This remarkable component has been engineered to provide superb surround sound listening with home theater sources such as DVD, as well as providing outstanding high fidelity reproduction of your favorite music sources.

As this product is provided with an immense array of features, we recommend that before you begin hookup and operation that you review the contents of this manual before proceeding.

## Contents

<b>Getting Started</b>	
Accessories	2
Before using	2
Cautions on installation	3
Cautions on handling	3
Preparing the remote control unit	3
Inserting the batteries	3
Operating range of the remote control unit	3
<b>Part names and functions</b>	
Front panel	4
Display	4
Rear panel	5
Remote control unit	5
<b>Easy Setup and Operation</b>	
Easy to setup flow	6
Speaker system layout	6
Speaker connections	7
Connecting a DVD player and monitor (TV)	8
<b>Auto Setup / Room EQ</b>	9
Connecting a microphone	10
Turning on the power	10
Starting Auto Setup	11
Power Amp Assign	11
Preliminary measurements	11, 12
Speaker system measurement	12
Check of the measurement result	12, 13
About the error message	13
<b>Playing a DVD with surround sound</b>	13
<b>Connecting Other Sources</b>	
Cable indications	14
The video conversion function	15
On screen display for component video outputs and HDMI output	15
Connecting equipment with HDMI (High-Definition Multimedia Interface) terminals [To convert analog video signals to HDMI signals]	16
Connecting a TV tuner	16
Connecting a DBS tuner	16
Connecting the external inputs (EXT. IN) terminals	17
Connecting a video camera component or video game	17
Connecting a CD player	17
Connecting a turntable	17
Connecting a VCR	18
Connecting a DVD recorder	18
Connecting a CD recorder or MD recorder	19
Connecting a tape deck	19
DENON LINK connection	19
Connecting equipment with HDMI (High-Definition Multimedia Interface) terminals	20
Connecting the antenna terminals	21
Connecting the XM terminal	21
Connecting the RS-232C terminal	22
Connecting the TRIGGER OUT terminals	22
Connecting the MULTI ZONE terminals	
ZONE2 (or ZONE3) pre-out connections	22
ZONE2 / ZONE3 speaker out connections	23
Connecting the pre-out terminals	23
Connecting the power supply cord	23
<b>Basic Operation</b>	
<b>Playback</b>	
Operating the remote control unit	24
Playing the input source	25
Playback using the external input (EXT. IN) terminals	26
Turning the sound off temporarily (MUTING)	26
Listening over headphones	26
Combining the currently playing sound with the desired image (VIDEO SELECT)	26
Switching the surround speakers	26
Checking the currently playing program source, etc.	27
Input mode	27, 28
Room EQ function	28
<b>Surround</b>	
Playing modes for different sources	29
Playing audio sources (CDs and DVDs)	
2-channel playback modes	30
Dolby Digital mode and DTS surround (only with digital input)	31

Night mode	31
Dolby Pro LogicIIx (Pro LogicII) mode	33
DTS NEO:6 mode	35
Memory and call-out functions (USER MODE function)	36
<b>DENON original surround modes</b>	
Surround modes and their features	36
DSP surround simulation	37, 38
Tone control setting	38
Channel level	39
Fader function	39
<b>Listening to the radio</b>	
Auto tuning	40
Manual tuning	40
Preset memory	41
Checking the preset stations	41
Recalling preset stations	41
<b>XM Satellite Radio</b>	
Checking the XM signal strength and Radio ID	42
Channel selection	42
Category search	42
Direct access of channels	43
<b>Playing the iPod</b>	
Connecting the iPod	44
Listening to music	45
Viewing still pictures (only for iPods equipped with the slideshow function)	45
Disconnecting the iPod	45
<b>Using the Network Audio Function</b>	
Internet radio function	46
Music server function	46
System requirements	46, 47
Listening to Internet radio	47, 48
Presetting (registering) Internet radio stations	48
Registering Internet radio stations in your favorites	48
Character search function (searching by first letter)	49
Updating the list of radio stations	49
Playing music files stored on the computer (music server)	50
Operating the AVR-4306 using a browser	50
Playing the USB (mass storage) device	50

■ System setup menu

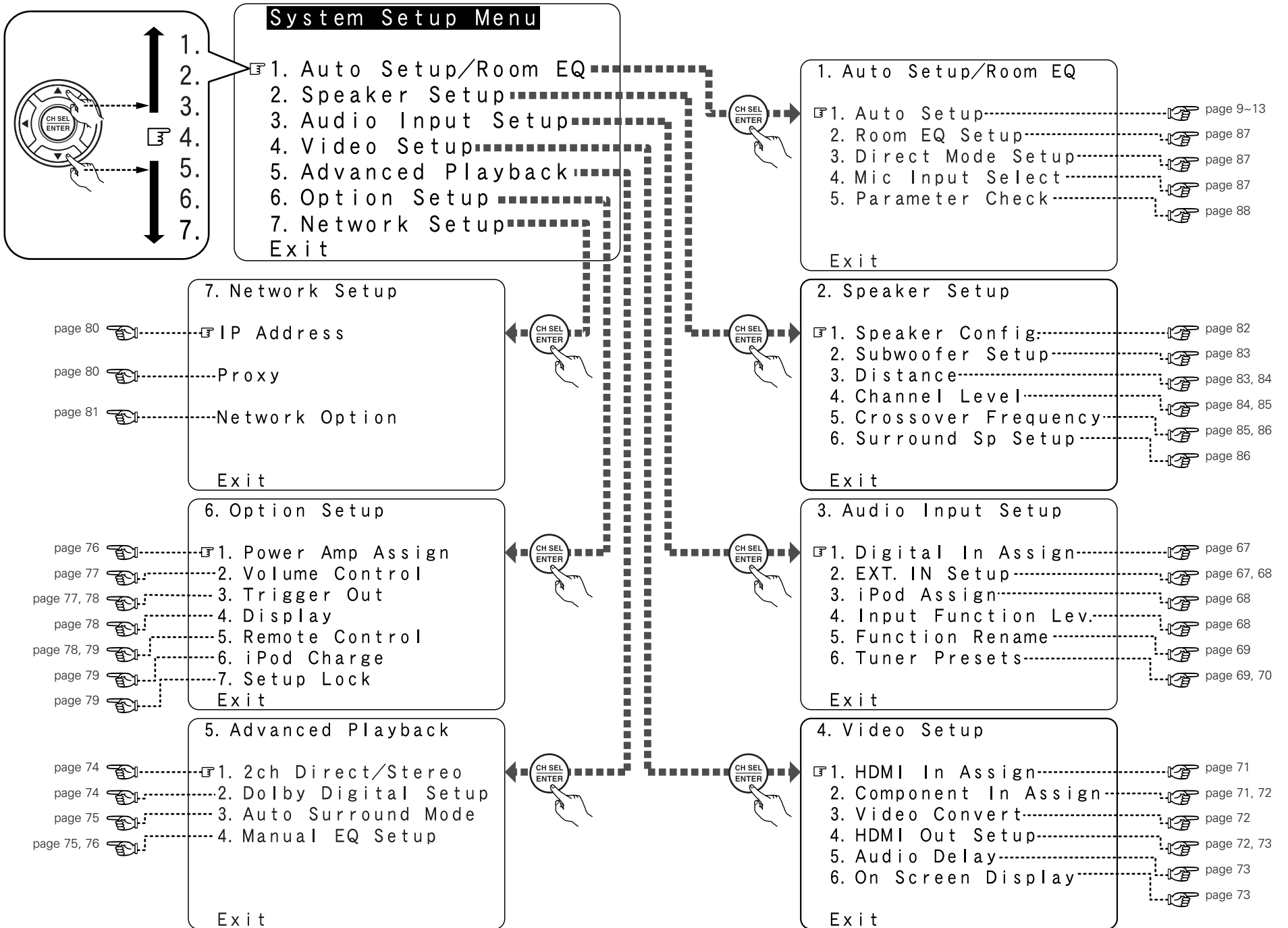

- We greatly appreciate your purchase of the AVR-4306.
- To be sure you take maximum advantage of all the features the AVR-4306 has to offer, read these instructions carefully and use the set properly. Be sure to keep this manual for future reference should any questions or problems arise.

“SERIAL NO. \_\_\_\_\_

PLEASE RECORD UNIT SERIAL NUMBER ATTACHED TO THE REAR OF THE CABINET FOR  
FUTURE REFERENCE”

MEMO \_\_\_\_\_

Advanced Operation	
<b>Remote control unit</b>	
Operating DENON audio components .....	51, 52
Preset memory .....	53
Operating a component stored in the preset memory .....	53 ~ 55
Learning function .....	56
System call .....	57
Punch through .....	57
Setting the back light's lighting time .....	58
Setting the ambient light sensor .....	58
Setting the brightness .....	58
Resetting .....	59
<b>Multi zone music entertainment system</b>	
Multi-zone playback using the ZONE2 and ZONE3 PREOUT terminals .....	60
Multi-zone playback using the SPEAKER terminals .....	61
Outputting a program source to amplifier, etc., in the ZONE2 (or ZONE3) room (ZONE2 or ZONE3 SELECT mode) .....	62
Remote control unit operations during multi-source playback .....	62
<b>Other function</b>	
Playing Super Audio CDs with DENON LINK .....	63
Multi-source recording / playback .....	64
Last function memory .....	64
Initialization of the microprocessor .....	64
Advanced Setup – Part 1	
<b>Navigating through the System Setup Menu</b> .....	65
<b>On screen display and front display</b> .....	66
<b>Audio Input Setup</b>	
Setting the Digital In Assignment .....	67
• Setting the DENON LINK .....	67
Setting the EXT. IN Setup .....	67, 68
Setting the iPod Assignment .....	68
Setting the Input Function Level .....	68
Setting the Function Rename .....	69
Tuner Presets .....	69, 70
<b>Video Setup</b>	
Setting the HDMI In Assignment .....	71
Setting the Component In Assignment .....	71, 72
Setting the Video Convert .....	72
Setting the HDMI Out Setup .....	72, 73
Setting the Audio Delay .....	73
Setting the On Screen Display (OSD) .....	73
<b>Advanced Playback</b>	
Setting the 2ch Direct / Stereo .....	74
Setting the Dolby Digital Setup .....	74
Setting the Auto Surround Mode .....	75
Setting the Manual EQ Setup .....	75
Procedure for copying the "Flat" correction curve .....	76

<b>Option Setup</b>	
Setting the Power Amplifier Assignment .....	76
Setting the Volume Control .....	77
Setting the Trigger Out .....	77, 78
Setting the Display .....	78
Setting the Remote Control .....	78, 79
Setting the iPod Charge .....	79
Setup Lock .....	79
<b>Network Setup</b>	
Setting the IP Address .....	80
Setting the Proxy .....	80
Setting the Network Option .....	81

Advanced Setup – Part 2	
<b>Speaker Setup</b>	
Setting the type of speakers .....	82, 83
Setting the low frequency distribution .....	83
Setting the Distance .....	83, 84
Setting the Channel Level .....	84, 85
Setting the Crossover Frequency .....	85, 86
Setting the crossover frequency individually for the different channels .....	86
Selecting the surround speakers for the different surround modes .....	86
<b>Others Setup</b>	
Setting the Room EQ Setup .....	87
Setting the Direct Mode Setup .....	87
Setting the MIC Input Select .....	87
Check the parameter .....	88
<b>System setup items and default values</b> .....	89~91

<b>Additional Information</b> .....	92~104
<b>Troubleshooting</b> .....	105, 106
<b>Specifications</b> .....	106
<b>List of preset codes</b> .....	End of this manual

**Accessories**

Check that the following parts are included in addition to the main unit:

① Operating instructions .....	1
② Warranty (for North America model only) .....	1
③ Service station list .....	1
④ Power supply cord .....	1
⑤ Remote control unit (RC-1024) .....	1
⑥ LR6/AA alkaline batteries .....	2
⑦ AM loop antenna .....	1
⑧ FM indoor antenna .....	1
⑨ Setup microphone (DM-S205) .....	1

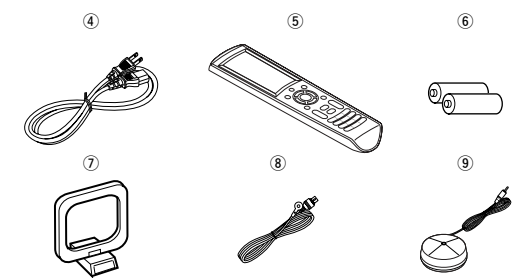

**Before using**

Pay attention to the following before using this unit:

- **Moving the unit**  
To prevent short-circuits or damaged wires in the connection cables, always unplug the power supply cord and disconnect the connection cables between all other audio components when moving the unit.
- **Before turning the power switch on**  
Check once again that all connections are correct and that there are not problems with the connection cables. Always set the power switch to the standby position before connecting and disconnecting connection cables.
- **Store these instructions in a safe place.**  
After reading, store this instructions along with the warranty card in a safe place.
- **Note that the illustrations in these instructions may differ from the actual unit for explanation purposes.**

### Cautions on installation

Noise or disturbance of the picture may be generated if this unit or any other electronic equipment using microprocessors is used near a tuner or TV.

If this happens, take the following steps:

- Install this unit as far away as possible from the tuner or TV.
- Run the antenna wires from the tuner or TV away from this unit's power supply cord and input/output connection cables.
- Noise or disturbance tends to occur particularly when using indoor antennas or 300  $\Omega$ /ohms feeder wires. **We recommend using outdoor antennas and 75  $\Omega$ /ohm coaxial cables.**

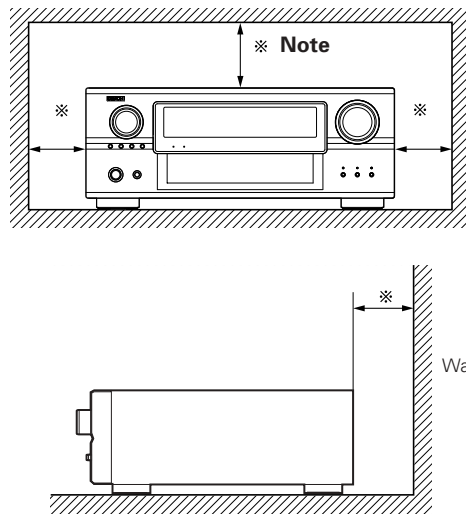

#### Note:

For heat dispersal, do not install this unit in a confined space such as a bookcase or similar enclosure.

### Cautions on handling

#### • Switching the input source when input terminals are not connected.

A clicking noise may be produced if the input source is switched when nothing is connected to the input terminals. If this happens, either turn down the MASTER VOLUME control knob or connect components to the input terminals.

#### • Muting of PRE OUT terminals, PHONES jack and SPEAKER terminals.

The PRE OUT terminals, PHONES jack and SPEAKER terminals include a muting circuit. Because of this, the output signals are greatly attenuated for several seconds after the power switch is turned on or the input source, surround mode or any other set-up is changed. If the volume is turned up during this time, the output will be very high after the muting circuit stops functioning. Always wait until the muting circuit turns off before adjusting the volume.

#### • Whenever the power switch is in the STANDBY state, the unit is still connected to AC line voltage.

**Please be sure to turn off the power switch or unplug the cord when you leave home for, say, a vacation.**

### Preparing the remote control unit

The included remote control unit (RC-1024) can be used to operate not only the AVR-4306 but other remote control compatible DENON components as well. In addition, the memory contains the control signals for other remote control units, so it can be used to operate non-DENON remote control compatible products.

### Inserting the batteries

- ① Remove the remote control unit's rear cover.

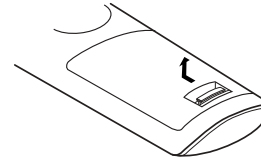

- ② Set two LR6/AA batteries in the battery compartment in the indicated direction.

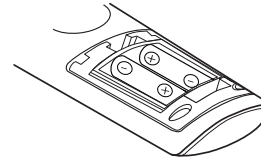

- ③ Put the rear cover back on.

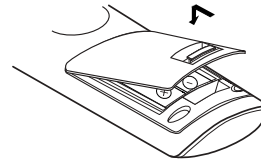

#### Notes on batteries:

- Replace the batteries with new ones if the set does not operate even when the remote control unit is operated nearby the unit. (The included batteries are only for verifying operation.)
- When inserting the batteries, be sure to do so in the proper direction, following the “ $\oplus$ ” and “ $\ominus$ ” marks in the battery compartment.
- To prevent damage or leakage of battery fluid:
  - Do not use a new battery together with an old one.
  - Do not use two different types of batteries.
  - Do not short-circuit, disassemble, heat or dispose of batteries in flames.
- If the battery fluid should leak, carefully wipe the fluid off the inside of the battery compartment and insert new batteries.
- When replacing the batteries, have the new batteries ready and insert them as quickly as possible.

### Operating range of the remote control unit

- Point the remote control unit at the remote sensor on the main unit as shown in the diagram.
- The remote control unit can be used from a straight distance of approximately 23 feet/7 meters from the main unit, but this distance will be shorter if there are obstacles in the way or if the remote control unit is not pointed directly at the remote sensor.
- The remote control unit can be operated at a horizontal angle of up to 30 degrees with respect to the remote sensor.

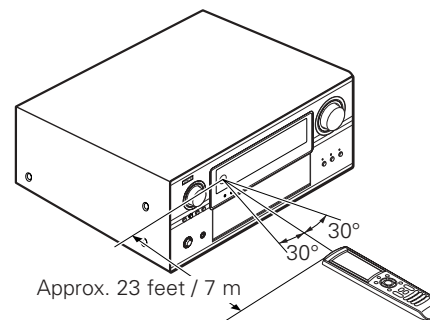

#### NOTE:

- It may be difficult to operate the remote control unit if the remote sensor is exposed to direct sunlight or strong artificial light.
- Do not press buttons on the main unit and remote control unit simultaneously. Doing so may result in malfunction.
- Neon signs or other devices emitting pulse-type noise nearby may result in malfunction, so keep the set as far away from such devices as possible.



Part names and functions

Front panel

For details on the functions of these parts, refer to the pages given in parentheses ( ).

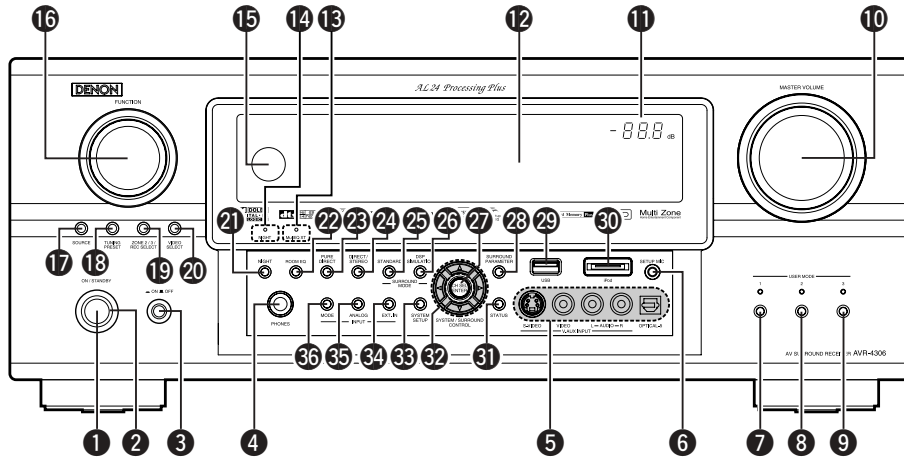

- ❶ Power ON/STANDBY button .....(10)
- ❷ Power indicator .....(10)
- ❸ Power switch .....(10, 64)
- ❹ Headphones jack (PHONES) .....(26)
- ❺ V.AUX INPUT terminals .....(17)
- ❻ SETUP MIC jack .....(10)
- ❼ USER MODE 1 button .....(36)
- ❽ USER MODE 2 button .....(36)
- ❾ USER MODE 3 button .....(36)
- ❿ MASTER VOLUME control knob .....(25)
- ⓫ Master volume indicator .....(25)
- ⓬ Display
- ⓭ MultEQ XT indicator .....(28)
- ⓮ NIGHT indicator .....(31)
- ⓯ Remote control sensor .....(3)
- ⓰ FUNCTION knob .....(25)
- ⓱ SOURCE button .....(25)
- ⓲ TUNING PRESET button .....(40)
- ⓳ ZONE2/3/REC SELECT button .....(62, 64)
- ⓴ VIDEO SELECT button .....(26)
- ⓵ NIGHT button .....(31)
- ⓶ ROOM EQ button .....(28)
- ⓷ PURE DIRECT button .....(30)
- ⓸ DIRECT/STEREO button .....(30)
- ⓹ STANDARD button .....(25)
- ⓺ DSP SIMULATION button .....(37)
- ⓻ CH SELECT/ENTER button .....(39)
- ⓼ SURROUND PARAMETER button .....(31)
- ⓽ USB connector .....(50)
- ⓾ iPod connector .....(44)
- ⓿ STATUS button .....(27)
- ⓿ CURSOR button .....(11)
- ⓿ SYSTEM SETUP button .....(11)
- ⓿ EXT. IN button .....(26)
- ⓿ ANALOG button .....(28)
- ⓿ INPUT MODE button .....(26)

Display

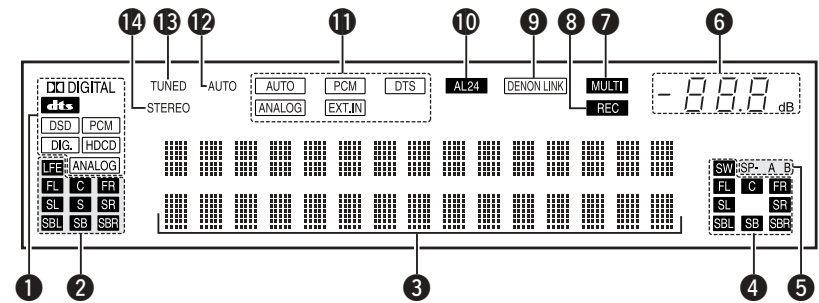

- ❶ **Input signal indicator**  
The respective indicator will light corresponding to the input signal.
- ❷ **Input signal channel indicator**  
The channels included in the input source will light.  
This lights when the digital signal is inputted.
- ❸ **Information display**  
This displays the surround mode, function name or setting value, etc.
- ❹ **Output signal channel indicator**  
The audio channels that can be output light.
- ❺ **Speaker indicator**  
This lights corresponding to the settings of the surround speakers of the various surround modes.
- ❻ **Master volume indicator**  
This displays the volume level.  
The Setup item number is displayed in System Setup.
- ❼ **MULTI (zone) indicator**  
ZONE2 mode is selected in ZONE2/REC SELECT.
- ❽ **Recording output source indicator**  
REC OUT mode is selected in ZONE2/REC SELECT.
- ❾ **DENON LINK indicator**  
This lights during playback in a DENON LINK connection.
- ❿ **AL24 indicator**  
The AL24 indicator lights when the PURE DIRECT, DIRECT, STEREO, MULTI CH PURE DIRECT, MULTI CH DIRECT, MULTI CH IN mode is selected in the PCM input signal.
- ⓫ **Input mode indicator**  
This lights corresponding to the setting of the input mode.
- ⓬ **AUTO indicator**  
This lights when the broadcast station is selected in the AUTO tuning mode.
- ⓭ **TUNED indicator**  
This lights when an FM/AM broadcast has been received.
- ⓮ **STEREO indicator**  
This lights when an FM stereo broadcast has been received.

Rear panel

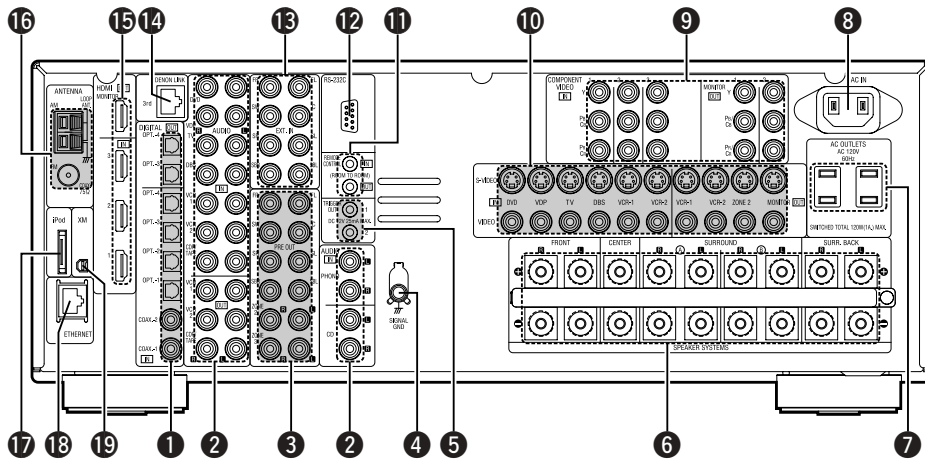

- 1 Digital audio terminals (Optical/Coaxial) .....(8)
- 2 Analog audio terminals .....(8)
- 3 Pre-out terminals .....(23)
- 4 SIGNAL GND terminal.....(18)
- 5 12V TRIGGER OUT terminals .....(22)
- 6 Speaker terminals.....(7)
- 7 AC outlet (s) .....(23)
- 8 AC inlet .....(23)
- 9 Component video terminals .....(8)
- 10 Video/S-Video terminals.....(8)
- 11 Remote control terminals .....(22)
- 12 RS-232C terminal .....(22)
- 13 EXT. IN terminals .....(17)
- 14 DENON LINK terminal .....(19)
- 15 HDMI terminals .....(20)
- 16 AM/FM antenna terminals.....(21)
- 17 iPod connector.....(44)
- 18 ETHERNET terminal.....(47)
- 19 XM terminal.....(21)

Remote control unit

For details on the functions of these parts, refer to the pages given in parentheses ( ).

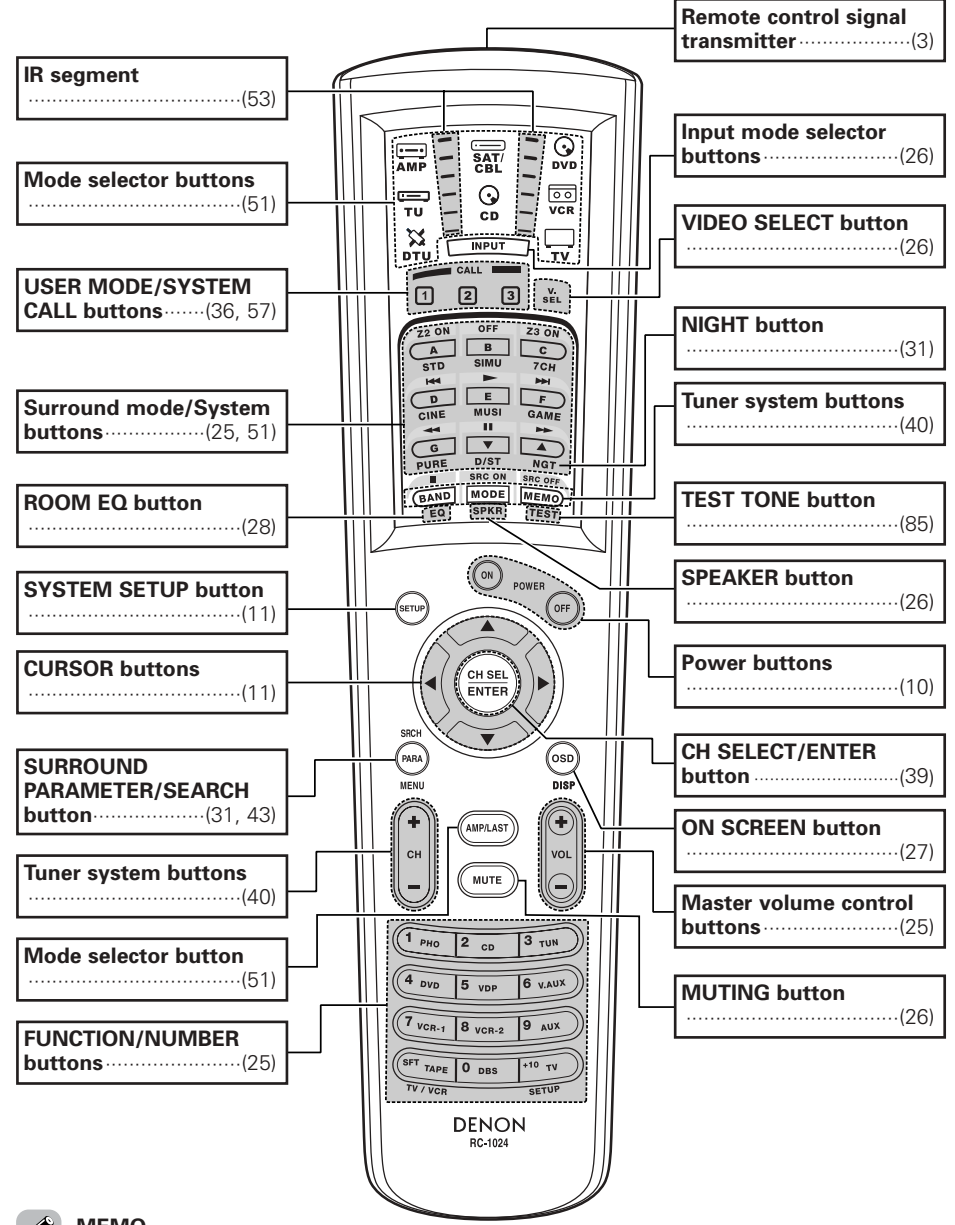

- IR segment .....(53)
- Mode selector buttons .....(51)
- USER MODE/SYSTEM CALL buttons .....(36, 57)
- Surround mode/System buttons .....(25, 51)
- ROOM EQ button .....(28)
- SYSTEM SETUP button .....(11)
- CURSOR buttons .....(11)
- SURROUND PARAMETER/SEARCH button .....(31, 43)
- Tuner system buttons .....(40)
- Mode selector button .....(51)
- FUNCTION/NUMBER buttons .....(25)
- Remote control signal transmitter .....(3)
- Input mode selector buttons .....(26)
- VIDEO SELECT button .....(26)
- NIGHT button .....(31)
- Tuner system buttons .....(40)
- TEST TONE button .....(85)
- SPEAKER button .....(26)
- Power buttons .....(10)
- CH SELECT/ENTER button .....(39)
- ON SCREEN button .....(27)
- Master volume control buttons .....(25)
- MUTING button .....(26)

MEMO

- For instructions on setting the remote control unit back light's lighting time (page 58).

# Easy Setup and Operation

- This section contains the basic steps necessary to configure the AVR-4306 according to your listening room environment and the source equipment and loudspeakers you are using.
- For optimum performance, we recommend using the Auto Setup function.
- If you wish, you can set the various settings manually without using Auto Setup (☞ page 82 ~ 86).

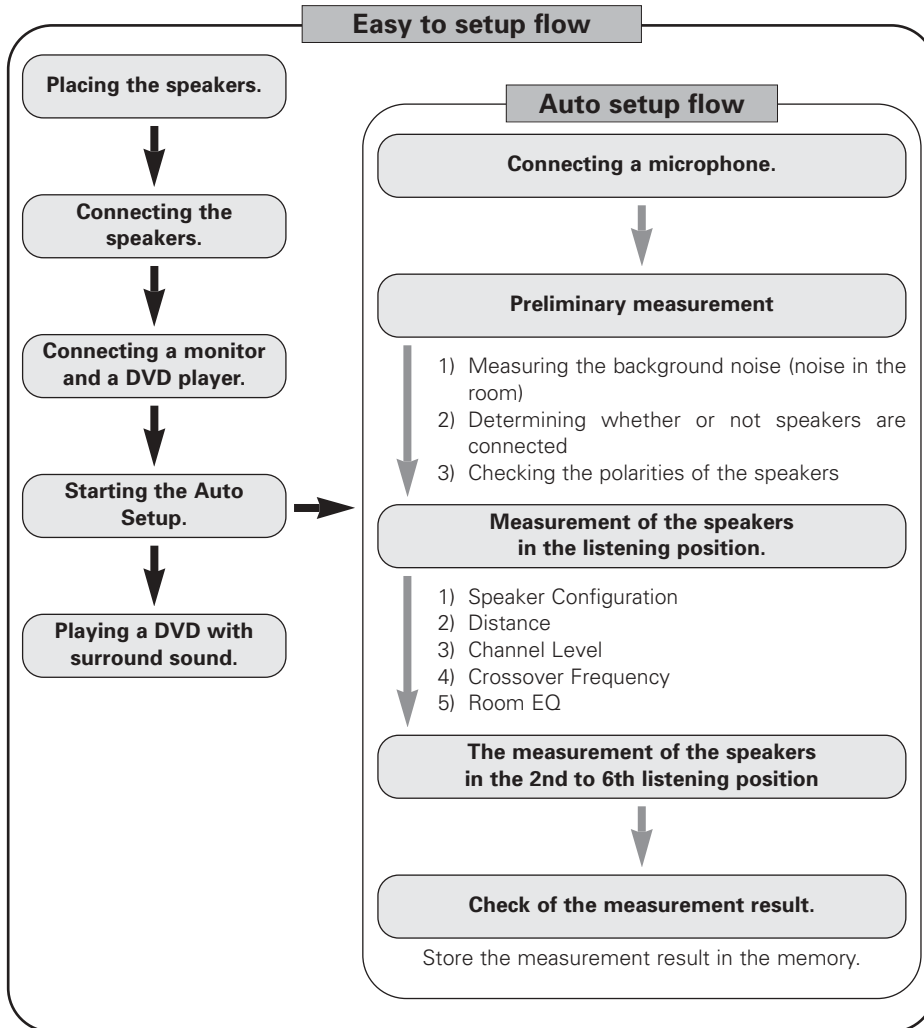

## Speaker system layout

### Basic system layout

The following is an example of the basic layout for a system consisting of eight speaker systems and a television monitor:

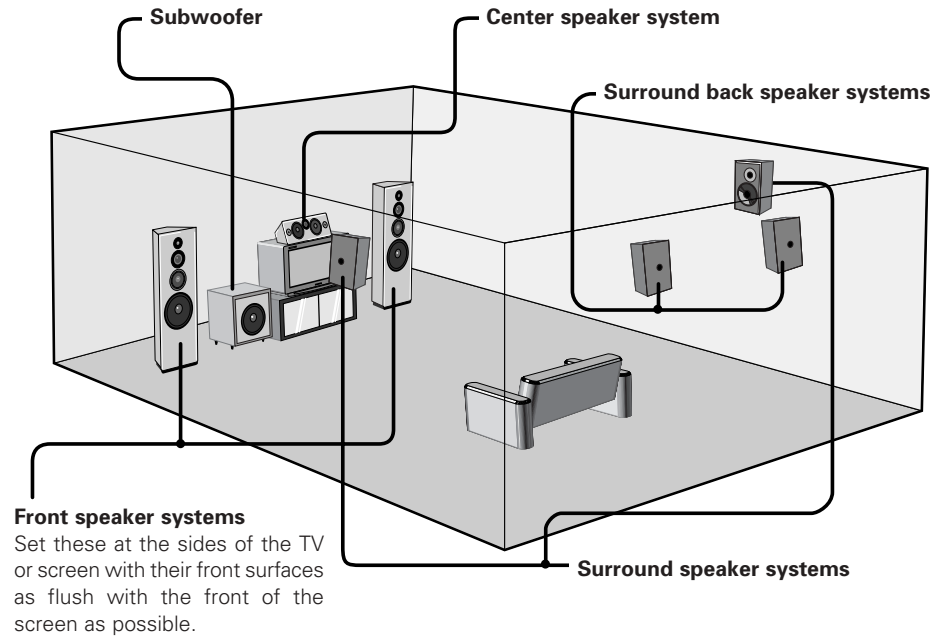

With the AVR-4306 it is also possible to use the surround speaker selector function to choose the best layout for a variety of sources and surround modes.

### Surround speaker selector function

This function makes it possible to achieve the optimum sound fields for different sources by switching between two systems of surround speakers (A and B). The settings of the different speakers (A only, B only or A+B) are stored in the memory for the different surround modes, so they are set automatically when the surround mode is selected.

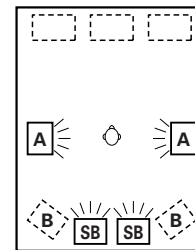

Using A only  
(Multi surround speaker system)

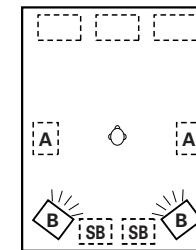

Using B only  
(Single surround speaker system)

(SB : Surround back speakers)

**Speaker connections**

- Connect the speaker terminals with the speakers making sure that like polarities are matched (⊕ with ⊕, ⊖ with ⊖). Mismatching of polarities will result in weak central sound, unclear orientation of the various instruments, and the stereo image being impaired.

**NOTE:**  
**NEVER touch the speaker terminals when the power is on. Doing so could result in electric shocks.**  
**When making connections, take care that none of the individual conductors of the speaker cable come in contact with adjacent terminals, with other speaker cable conductors, or with the rear panel and screws.**

**Speaker impedance**

- Speakers with an impedance of from 6 to 16 Ω/ohms can be connected for use as front, center, surround and surround back speakers.
- Be careful when using two pairs of surround speakers (A + B) at the same time, since use of speakers with an impedance of less than 8 Ω/ohms will lead to damage.

**Note on speaker impedance**

The protector circuit may be activated if the set is played for long periods of time at high volumes when speakers with an impedance lower than the specified impedance (for example speakers with an impedance of lower than 4 Ω/ohms) are connected. If the protector circuit is activated, the speaker output is cut off. Turn off the set's power, wait for the set to cool down, improve the ventilation around the set, then turn the power back on.

**Connecting the speaker cables**

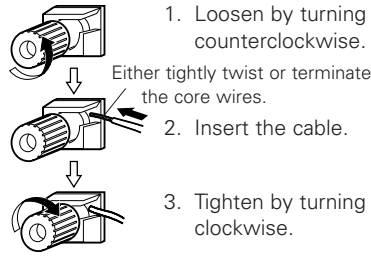

**Connecting banana plugs**

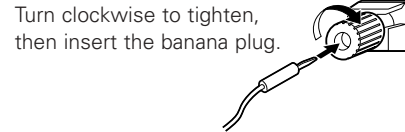

**Protector circuit**

This unit is equipped with a high-speed protection circuit. The purpose of this circuit is to protect the speakers under circumstances such as when the output of the power amplifier is inadvertently short-circuited and a large current flows, when the temperature surrounding the unit becomes unusually high, or when the unit is used at high output over a long period which results in an extreme temperature rise. When the protection circuit is activated, the speaker output is cut off and the power supply indicator flashes. Should this occur, please follow these steps: be sure to switch off the power of this unit, check whether there are any faults with the wiring of the speaker cables or input cables, and wait for the unit to cool down if it is very hot. Improve the ventilation condition around the unit and switch the power back on. If the protection circuit is activated again even though there are no problems with the wiring or the ventilation around the unit, switch off the power and contact a DENON service center.

**Connections**

- The AVR-4306 can be configured for 10 speaker playback using two pairs of surround speakers (A+B) and one pair of surround back speakers as shown below.
- The output of the surround back's power amplifier can be assigned to the multi zone or front channel. For details, refer to "Setting the Power Amplifier Assignment" (page 76).
- When making connections, also refer to the operating instructions of the other components.

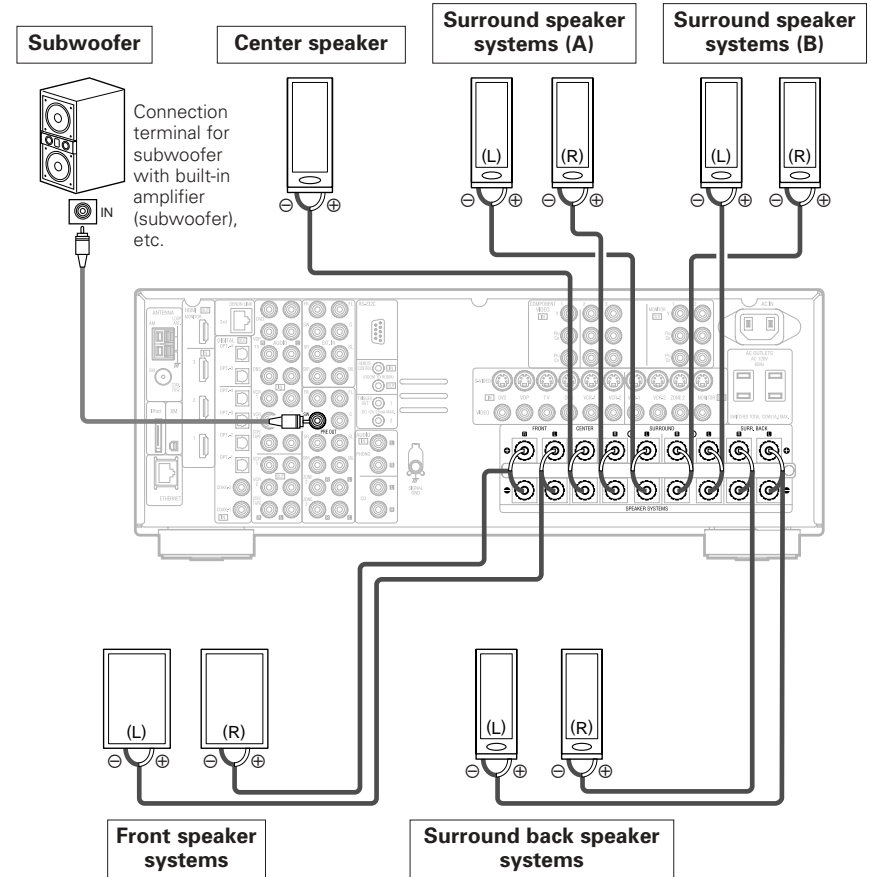

**Precautions when connecting speakers:**  
 If a speaker is placed near a TV or video monitor, the colors on the screen may be disturbed by the speaker's magnetism. If this should happen, move the speaker away to a position where it does not cause this effect.

**NOTE:**  
 • When using only one surround back speaker, connect it to the left channel.

## Easy Setup and Operation

### Connecting a DVD player and monitor (TV)

- To connect the video output from the DVD player to the AVR-4306, you only need to choose one connection type. Component video connection offers the best quality (and is required for progressive DVD playback), followed by S-Video, while composite video offers the lowest picture quality of the three connection types. For more information about the video up conversion function (👉 page 15).
- The AVR-4306 is equipped with HDMI connectors, so it can be connected to a DVD player or monitor (TV) using an HDMI cable.
- To connect the digital audio output from the DVD player, you can choose from either the coaxial or optical connections. If you choose to use the optical connection, it needs to be assigned. For more information about Digital Input Assignment (👉 page 67).
- The AVR-4306 is equipped with another set of input terminals for a non-DVD Video Disc Player (such as laser disc, VCD/SVCD, or future high definition disc player). The above connection guidelines for DVD also apply to the VDP input.

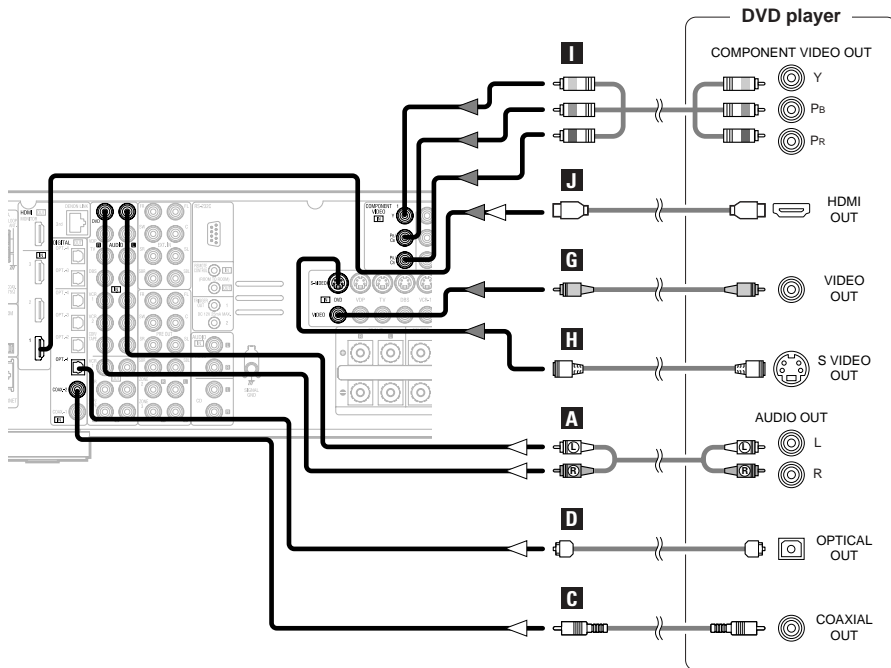

※ Audio signal flow is shown with white arrows; video signal flow is shown with gray arrows.

## Easy Setup and Operation

- For best picture quality (especially with progressive DVD and other high definition sources), choose the component video or HDMI connection to your monitor (TV). S-Video and composite video outputs are also provided if your TV does not have component video inputs.

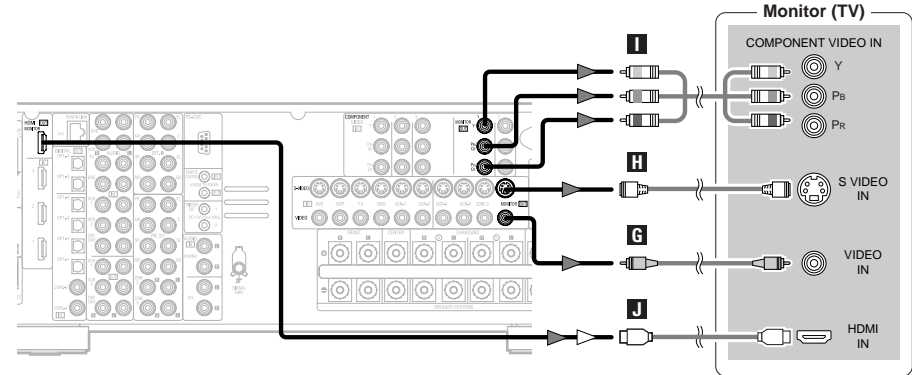

#### NOTE:

- The component video input and/or output jacks may be labelled differently on some TVs, monitors or video components (Y, Pb, Pr; Y, Cb, Cr; Y, B-Y, R-Y). Check the owner's manuals for other components for further information.
- The COMPONENT MONITOR OUT-1 and the COMPONENT MONITOR OUT-2 can be used simultaneously.
- Audio signals are only output from the HDMI monitor out terminal when audio signals are input to the HDMI input terminal.
- When connecting the AVR-4306 and DVD player using an HDMI cable, also connect the AVR-4306 and monitor (TV) using an HDMI cable (👉 page 20).

## Auto Setup / Room EQ

The Auto Setup and Room EQ function of this unit performs an analysis of the speaker system and measures the acoustic characteristics of your room to permit an appropriate automatic setting.

The AVR-4306's Audyssey MultEQ XT function has the feature that it provides the optimum listening environment at all listening positions in the home theater, where there are often multiple listeners viewing programs together. To achieve this, it is first necessary to use a microphone to measure test tones generated from the different speakers at the various listening positions. All this measured data is analyzed with a unique method to comprehensively improve acoustic characteristics in the listening area. For optimum effectiveness, measurements should be performed at **six points**. Move the microphone successively within the listening area surrounded by the speakers as shown on the diagram below to measure the test tones. When listening to music or viewing movies with the whole family, move the microphone successively to the different positions in which the members of the family sit ("■" on the diagram indicates the points of installation) and measure repeatedly (Example ①). Even if the number of people using the home theater is small, taking multiple measurements at or near the listening positions makes it possible to correct the sound more effectively (Example ②).

The AVR-4306's Room EQ function offers three correction curves: "Audyssey", "Front" and "Flat". These can be selected after performing the auto setup procedure. Details of the different correction curves are described below.

- **Audyssey:**

This adjusts the frequency response of all speakers to correct the effects of room acoustics.

- **Front:**

This adjusts the characteristics of each speaker to the characteristics of the front speakers.

- **Flat:**

This the frequency response of all speakers flat.

This is suitable for multi-channel music reproduction, from discrete music sources such as Dolby Digital 5.1, DTS, DVD-Audio and Super Audio CD.

### ■ About the main listening position (\*M)

The main listening position is the point where a listener sits most often or the listening position when only one person is listening. Measurements on the AVR-4306 start from this point. Correction for the speaker distance is set based on this point.



- To make the Speaker system settings without using the Auto Setup function (🔗 page 82 ~ 86).

Example: ①

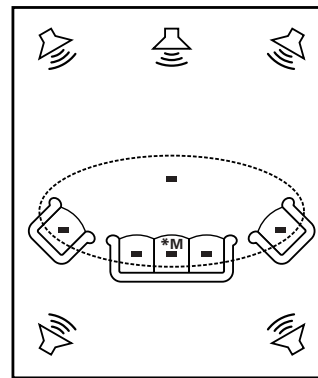

Example: ②

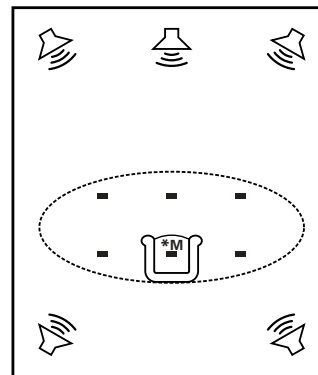

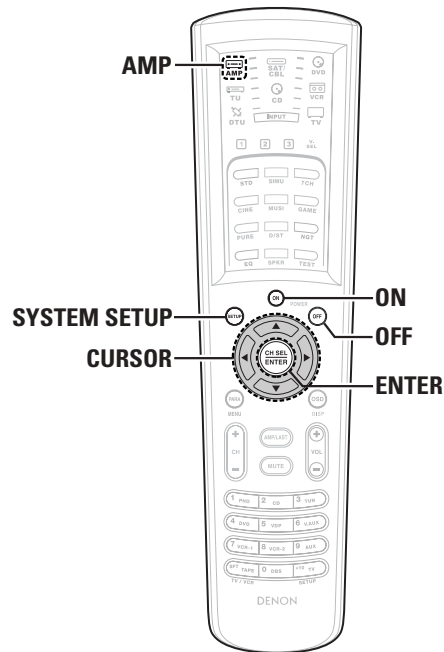
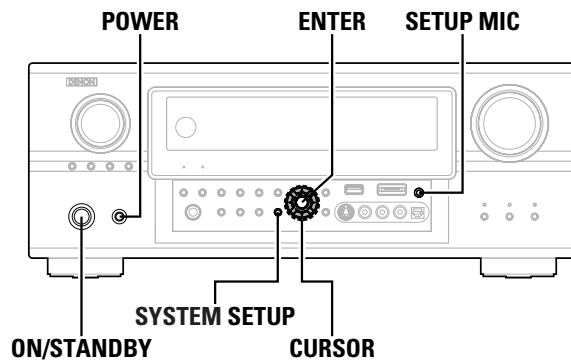

**Connecting a microphone**

**1** Connect the microphone for Auto Setup to the **SETUP MIC** jack on the front panel of the unit.

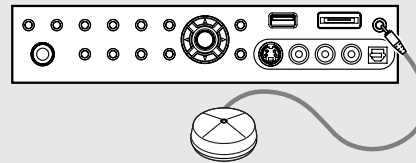

**2** Mount the auto setup microphone onto a camera tripod, etc., and place it at ear height at the main listening position in the listening room with the sound receptor facing the ceiling.

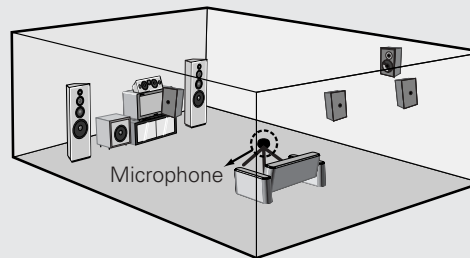

- \* When placing the microphone, adjust the height so that the microphone's sound receptor is at the height of the ears of the listener.
- \* Be sure that at the beginning, the measurement is started with the microphone set up at the main listening position.
- \* It is not possible to measure properly if there are any obstacles between the speakers and microphone. Check that there are no obstacles.
- \* Please do not stand between or near the speakers and the microphone during the measurements.

**NOTE:**

- Do not disconnect the microphone until the settings are completed.
- Do not change the connection of speakers or the subwoofer's volume after performing these measurements.

**Turning on the power**

**1** Turn on your subwoofer.

- \* Set the volume to halfway and set the crossover frequency to the maximum or Low pass filter off if your subwoofer can adjust the output volume and the crossover frequency
- \* Some subwoofers have a standby mode. Be sure to turn this function off before performing the Auto Setup procedure.

**2** Turn on your monitor (TV).

**3** Press the **POWER** switch.

**ON:**

The power turns on and the indicator lights. Set the **POWER** switch to this position to turn the power on and off from the included remote control unit.

**OFF:**

The power turns off and the indicator is off. In this position, the power cannot be turned on and off from the remote control unit.

**4** Press the **ON/STANDBY** button on the main unit or **ON** button on the remote control unit.

- When pressed, the power turns on and the display lights.
- When pressed again, the power turns off, the standby mode is set and the display turns off.

\* The sound is muted for several seconds, after which the unit operates normally.

\* When ever the **ON/STANDBY** button is in the standby state, the apparatus is still connected to the AC line voltage. Please be sure to turn off the **POWER** switch or unplug the cord when you leave home for, say, a vacation.

**5** Press the **AMP** button to select "AMP" mode (only when operating with the remote control unit (page 24)).

**Starting Auto Setup**

- 1** Press the **SYSTEM SETUP** button.  
 • The “System Setup Menu” appears.

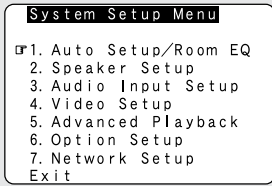

- 2** Press the **CURSOR**  $\Delta$  or  $\nabla$  button to select “Auto Setup / Room EQ”, then press the **ENTER** button.  
 • The “Auto Setup / Room EQ” menu screen appears.

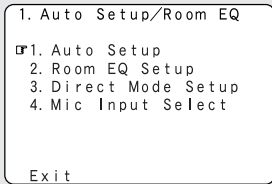

- 3** Press the **CURSOR**  $\Delta$  or  $\nabla$  button to select “Auto Setup”, then press the **ENTER** button.  
 • The “Auto Setup” screen appears.

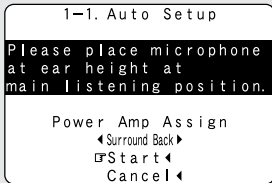

※ The message “Connect Microphone” is displayed if no microphone is connected. If so, connect the auto setup microphone.

**Power Amp Assign**

The AVR-4306 has available surround back amplifier channel. If no surround back speakers are used in the main room, their amplifier channels can be assigned for multi-zone use or the front speaker’s Bi-Amp connection. If this functionality is not needed, skip this “Power Amp Assign” procedure and proceed to “Preliminary Measurements”.

Press the **CURSOR**  $\Delta$  or  $\nabla$  button to select “Power Amp Assign”, then press the **CURSOR**  $\triangleleft$  or  $\triangleright$  button to select “Surround Back”, “Front”, “Front B”, “ZONE2” or “ZONE3”.

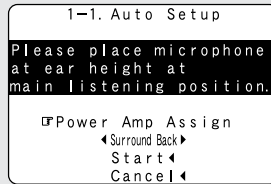

- ※ When “Surround Back” is selected, the surround back channel’s test tone during Auto Setup will be output from surround back speakers.
- ※ When “Front” is selected, change the setting to a Bi-Amp mode for the front speakers. The front channel’s test tone during Auto Setup will be output from the front speakers and the surround back speakers.
- ※ When “Front B” is selected, change the setting to a second stereo output mode. The test tone during Auto Setup will not be output from the surround back speakers.
- ※ When “ZONE2” or “ZONE3” is selected, change the setting to “ZONE2” or “ZONE3”. The test tone during Auto Setup it will not be output to “ZONE2” or “ZONE3” (Another room).

**Preliminary measurements**

- This procedure is used to automatically determine the background noise, whether or not speakers are connected, and the polarities of the connected speakers.
- To avoid affecting the measurements, turn off the air-conditioner or any other device that makes noise and take the measurements with the room as quiet as possible.
- The set measures the background noise even when in the silent state with no test tones being output, so keep as quiet as possible until the measurements are completed.

- 1** Press the **CURSOR**  $\Delta$  or  $\nabla$  button to select “Start”, then press the **CURSOR**  $\triangleleft$  button.  
 • The preliminary measurements start.

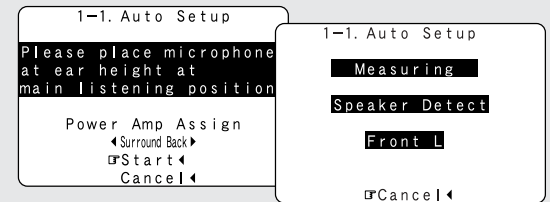

※ The screen shown at the below appears once the preliminary measurements are completed.

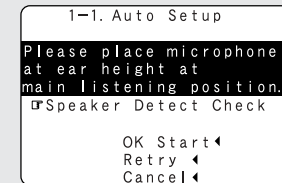

- 2** Press the **ENTER** button.  
 • The “Speaker Detect Check” screen appears.

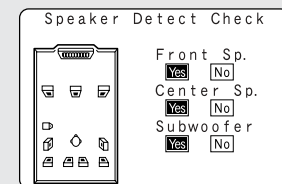

[ First screen ]



### 3 Check the results of the speaker detection, then press the ENTER button.

- The second screen appears.

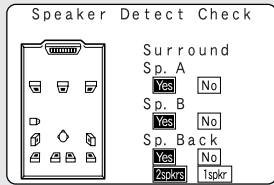

[ Second screen ]

### 4 If the check ends, press the ENTER button again.

**NOTE:**

- If the results are not as expected or if an error message is displayed, select "Retry" and perform the measurements again (For details on the error messages (page 13).) If the results of remeasurement are still not as expected or if an error message is displayed, turn off the power switch and check the speaker connections. Then start the measurements again from the beginning.
- Measurement is cancelled when **MASTER VOLUME** knob is operated while the Auto Setup is performed.

### Speaker system measurement

With these measurements, the "Speaker Configuration", "Distance", "Channel Level", "Crossover Frequency" and "Room EQ" are analyzed automatically. The main listening position is measured first, so leave the microphone where it is.

### 1 Press the CURSOR Δ or ▽ button to select "OK Start", then press the CURSOR ◀ button.

- Measurements for the first point start.

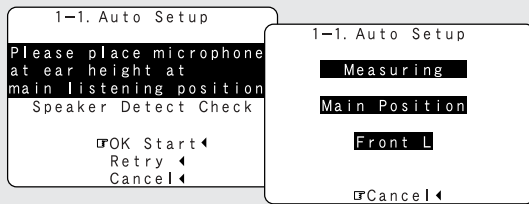

- The screen shown at the below appears once the measurements for the main listening position are completed.

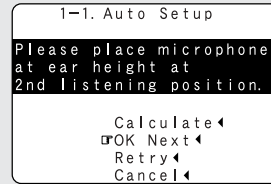

### 2 Next the measurements for the second point will be taken.

- Place the microphone at the second listening position. For instructions on the position in which the microphone should be placed (page 9).

### 3 Press the CURSOR ◀ button.

- Measurements for the second point start.

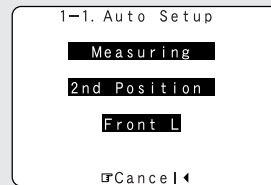

### 4 Perform step 2, 3 repeatedly.

- The more measurement points, the better the resulting room correction effect. We recommend 6 measurement points – 6 measurement points provides the best room correction effect.

### 5 After measuring at the number of points according to your listening environment, press the CURSOR Δ or ▽ button to select "Calculate", then press the CURSOR ◀ button.

- The speaker system is analyzed.

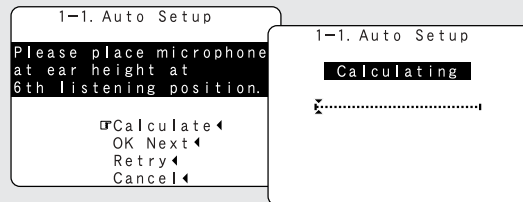

- The amount of time required for the analysis depends on the number of speakers and the number of measuring points. The greater the number of speakers and measuring points, the longer the time required.
- Measurements can be ended when there are 6 or less measurement locations; however, to obtain better results, measurements at **6 locations** is recommended.
- Once the calculations are completed, a screen for confirming the results of the measurements appears.

### Check of the measurement result

The results of the measured items can be checked.

### 1 Press the CURSOR Δ or ▽ button to select an item, then press the ENTER button.

- The verification screen appears.

**Example:** Speaker Config. Check

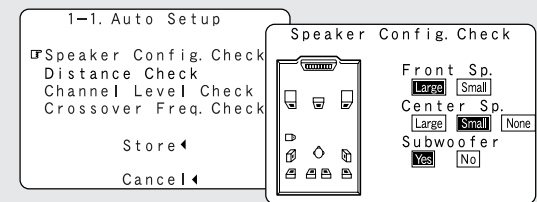

[ First screen ]

### 2 Press the ENTER button.

- The second screen appears.

**Example:** Speaker Config. Check

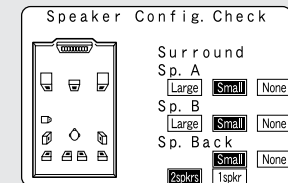

[ Second screen ]

**3** If the check ends, press the **ENTER** button again.

**4** Press the **CURSOR**  $\triangle$  or  $\nabla$  button to select whether or not to save the data you have checked.

**Store:**

Store the checked measurement values.  
All parameters are stored.

**Cancel:**

Cancel the auto setup settings.

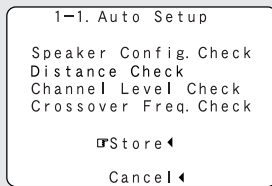

**5** Press the **CURSOR**  $\triangleleft$  button.  
• After the data is stored, the “Auto Setup / Room EQ” menu screen appears automatically.



• When measurements have been made using the measurement microphone, speakers with a built-in filter such as subwoofers might be set with a value that differs from the physical distance because of the internal electrical delay.

**NOTE:**

• Do not turn off the power while the data is being stored. If the power is turned off while the data is being stored, the Room EQ parameters stored in the memory will be cleared, and it will not be possible to select “Audyssey”, “Front” or “Flat” equalizer settings.

**About the error message**

These error messages will be displayed when performing the measurements of Auto Setup and the automatic measurements can not be completed because of the speaker arrangement, measurement environment, or other factors. Please check the following matters, reset the pertinent items, and measure again. Be sure to turn off the AVR-4306's power before checking the speaker connections.

Screen example	Cause	Measures
	<p>① The speakers required for producing suitable reproduction have not been detected.</p> <ul style="list-style-type: none"> <li>• The front L and front R speakers were not properly detected.</li> <li>• Only one channel of the surround (A) and surround (B) speakers was detected.</li> <li>• Sound was output from the R channel when only one surround back speaker was connected.</li> <li>• The surround back or the surround (B) speaker was detected, but the surround (A) speaker was not detected.</li> </ul> <p>※ If multiple errors occur, press the <b>CURSOR</b> <math>\triangleleft</math> or <math>\triangleright</math> button to check the contents.</p>	<ul style="list-style-type: none"> <li>• Check that the pertinent speakers are properly connected.</li> </ul>
	<p>② The speaker polarity is connected in reverse.</p> <p>※ If multiple errors occur, press the <b>CURSOR</b> <math>\triangleleft</math> or <math>\triangleright</math> button to check the contents.</p>	<ul style="list-style-type: none"> <li>• Check the polarity of the pertinent speakers.</li> <li>• For some speakers, the screen below may be displayed even though the speakers are properly connected. If so, select “Skip”.</li> </ul>
	<p>③ There is too much ambient noise in the room and the measurements cannot be made accurately.</p> <p>④ The sound level that is output from the speakers and/or subwoofer is too low.</p>	<ul style="list-style-type: none"> <li>• Either turn off the power of the device that generated the noise during the measurements or move the device away.</li> <li>• Try again at a time when it is quieter.</li> <li>• Check the placement and orientation of the loudspeakers.</li> <li>• Adjust the subwoofer's output level.</li> </ul>
	<p>⑤ The measurement microphone is not connected, or all of speakers have not been detected.</p>	<ul style="list-style-type: none"> <li>• Connect the measurement microphone to the microphone connector.</li> <li>• Check the speaker connection.</li> </ul>

**Playing a DVD with surround sound**

**1** Disconnect the microphone from the unit.

**2** Select the input source to be played.

**3** Select the play (surround) mode.

**4** Start DVD playback.

**5** Adjust the volume.

# Connecting Other Sources

## Cable indications

The hookup diagrams on the subsequent pages assume the use of the following optional connection cables (not supplied).

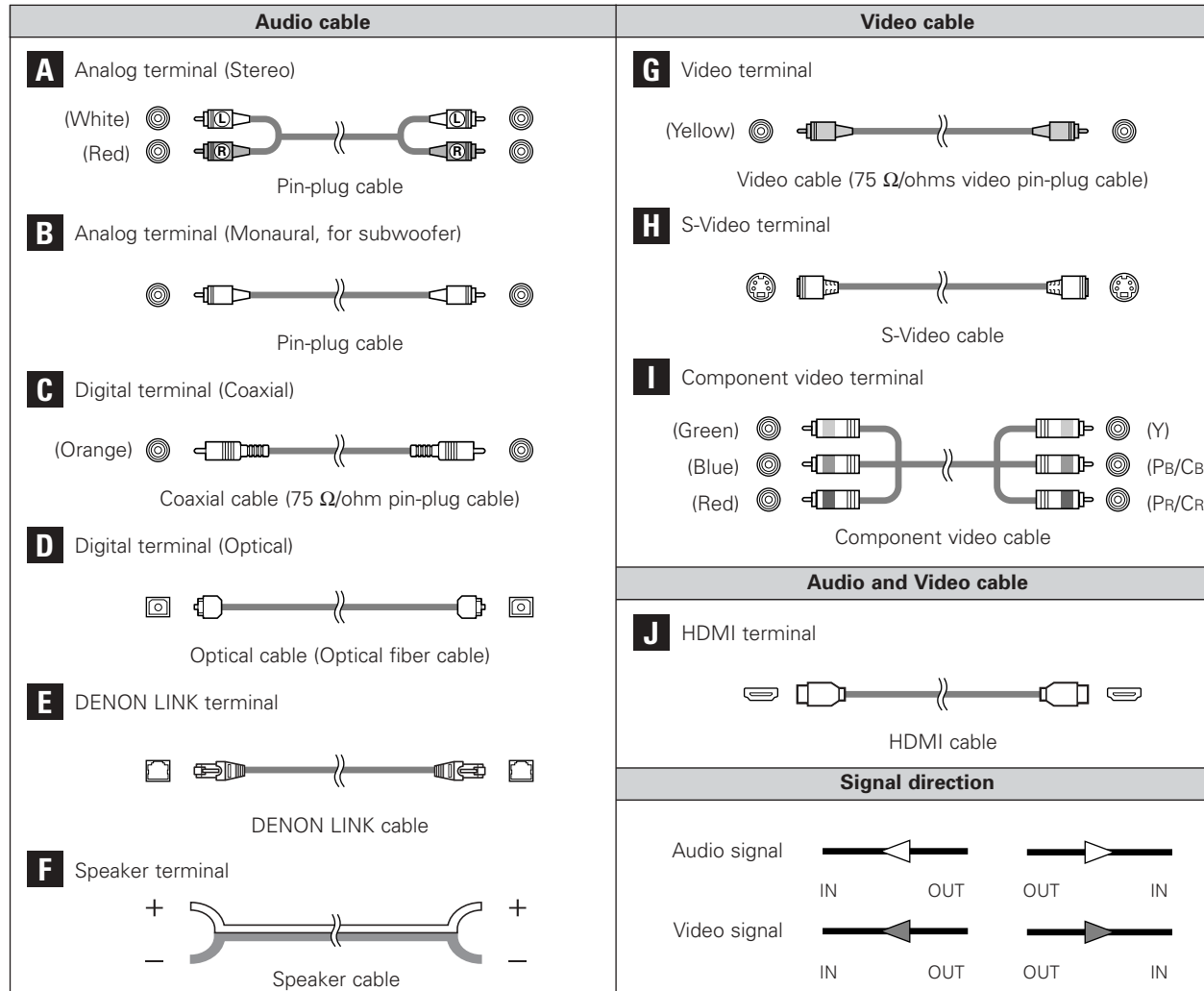

**NOTE:**

- Do not plug in the power supply cord until all connections have been completed.
- When making connections, also refer to the operating instructions of the other components.
- Be sure to connect the left and right channels properly (left with left, right with right).
- Note that binding pin-plug cables together with power supply cords or placing them near a power transformer will result in hum or other noise.

**NOTE:**

• **Connecting a LD (laser disc) player with a Dolby Digital RF Output.**

The AVR-4306 does not have a DD RF demodulator function. Therefore, you need to use a commercially available outboard DD RF demodulator and connect its digital output to one of the AVR-4306 available digital inputs. Refer to the demodulator's owner's manual for further information.

## The video conversion function

The AVR-4306 is equipped with a function for up and down converting video signals.

Because of this, the AVR-4306's MONITOR OUT terminal can be connected to the monitor (TV) with a set of cables offering a higher quality connection, regardless of how the player and the AVR-4306's video input terminals are connected.

Generally speaking, analog video connections using the component video terminals offer the highest quality playback, followed by connections using the S-Video terminals, then connections using the regular video terminals (yellow).

The flow of the video signals.

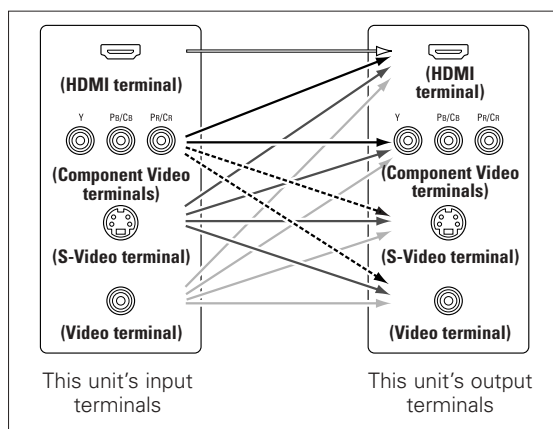

---: only MAIN ZONE 480i/576i

### NOTE:

- It is not possible to down-convert from HDMI input signals to the component, S-Video or composite video monitor output terminals.
- Video down conversion to the MAIN ZONE's monitor output is only possible when the component video input resolution is 480i (interlaced standard definition video – NTSC format, for North America) or 576i (interlaced standard definition video – PAL format, for Europe and other countries).
- To set the video conversion function for the MAIN ZONE to "OFF" (🔧 page 72).

### ■ The analog video to HDMI conversion function:

- The AVR-4306's video up-conversion function lets you output analog video input signals (component – 480i/576i, 480p/576p, 1080i or 720p; S-Video and composite video - 480i/576i) to the HDMI monitor output terminal.
- With the AVR-4306, the resolution of the signal output to the HDMI MONITOR OUT terminal can be selected (🔧 page 72, 73). The resolutions with which the monitor is compatible can be checked using the **STATUS** button on the main unit or the **ON SCREEN** button on the remote control unit.



- If you do not want to use the function for converting analog video signals to HDMI signals, select "OFF" for "Analog to HDMI Convert" at "Setting the HDMI Out Setup" (🔧 page 72, 73).

In this case, the function for video up conversion to the component video terminal operates.

## On screen display for component video outputs and HDMI output

- When viewing component video signals or HDMI signals via the AVR-4306, the on screen display is displayed on the monitor when the "System Setup" operations are performed and when the remote control unit's **ON SCREEN** button is operated.
- To view the on screen display using an HDMI monitor, set "Analog to HDMI Convert" at "HDMI Out Setup" to "ON" (default).
- When only component video signals are input to the AVR-4306, the characters of the on screen display are not displayed over the picture.

## Connecting Other Sources

### Connecting equipment with HDMI (High-Definition Multimedia Interface) terminals [To convert analog video signals to HDMI signals]

- The AVR-4306 is equipped with a function for converting analog video signals into HDMI signals. You can do this by either a component or a video or a S-Video connection.
- Audio signals are not output from the HDMI monitor output terminal, so also make analog or digital audio connections. To play sound using digital audio connections, assign the digital terminal (coaxial or optical) at "Setting the Digital In Assignment" (🔧 page 67).

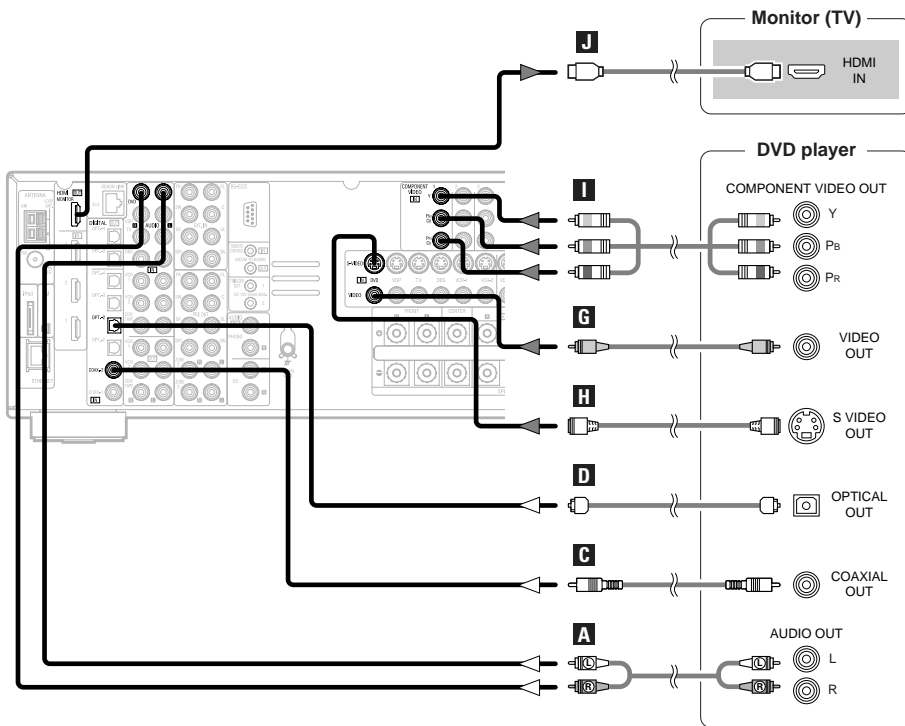

#### NOTE:

- When "Through" is set at "Resolution" under "Setting the HDMI Out Setup", use a monitor compatible with input resolutions of 480i/576i.
- If your monitor is not equipped with an HDMI terminal, connect the AVR-4306 to the monitor using the component video, S-Video, or composite video terminals.

## Connecting Other Sources

### Connecting a TV tuner

- For best picture quality choose the component video connection to your TV tuner. S-Video and composite video outputs are also provided if your TV tuner does not have component video inputs.
- To connect the digital audio output from the TV tuner, you can choose from either the coaxial or the optical connection. If you choose to use the coaxial or the optical connection, it needs to be assigned. For more information about Digital Input Assignment (🔧 page 67).

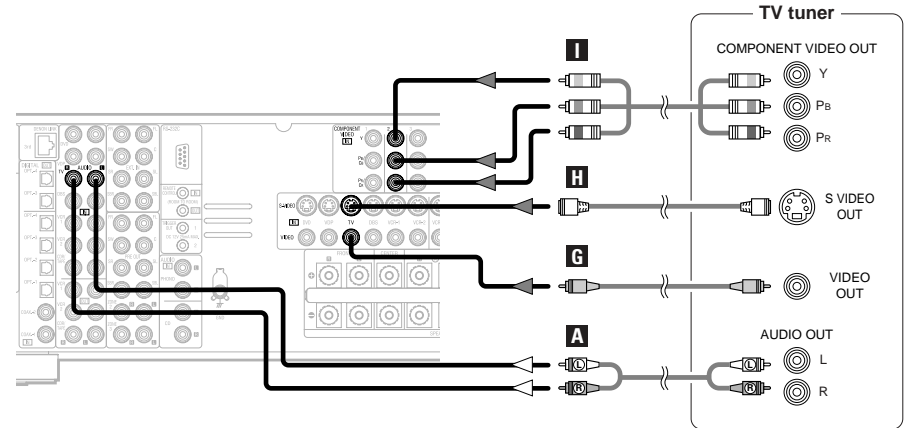

### Connecting a DBS tuner

- For best picture quality choose the component video connection to your DBS tuner. S-Video and composite video outputs are also provided.
- To connect the digital audio output from the DBS tuner, you can choose from either the coaxial or the optical connection. If you choose to use the coaxial connection, it needs to be assigned. For more information about Digital Input Assignment (🔧 page 67).

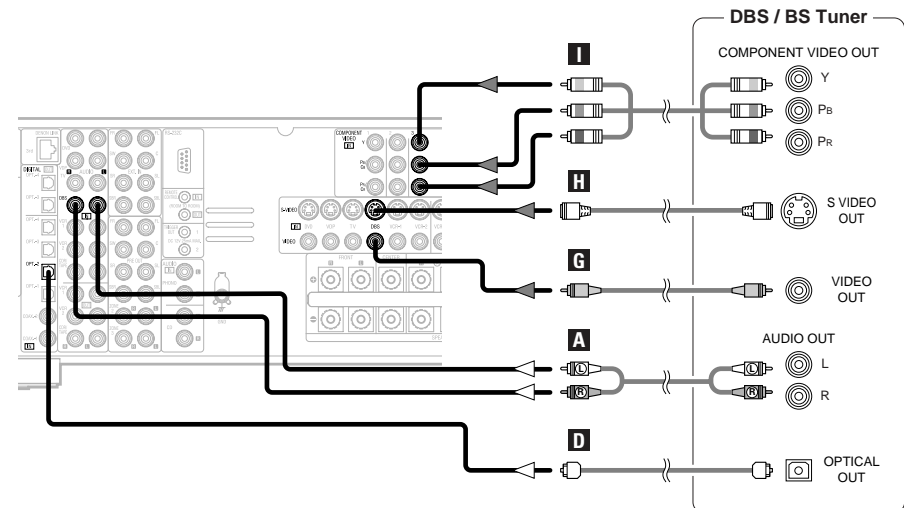

## Connecting Other Sources

### Connecting the external inputs (EXT. IN) terminals

- These terminals are for inputting multi-channel audio signals from an outboard decoder, or a component with a different type of multi-channel decoder, such as a DVD-Audio player, or a multi-channel Super Audio CD player, or other future multi-channel sound format decoder.
- The video signal connection is the same as that for a DVD player (page 8).
- For instructions on playback using the external input (EXT. IN) terminals (page 67, 68).

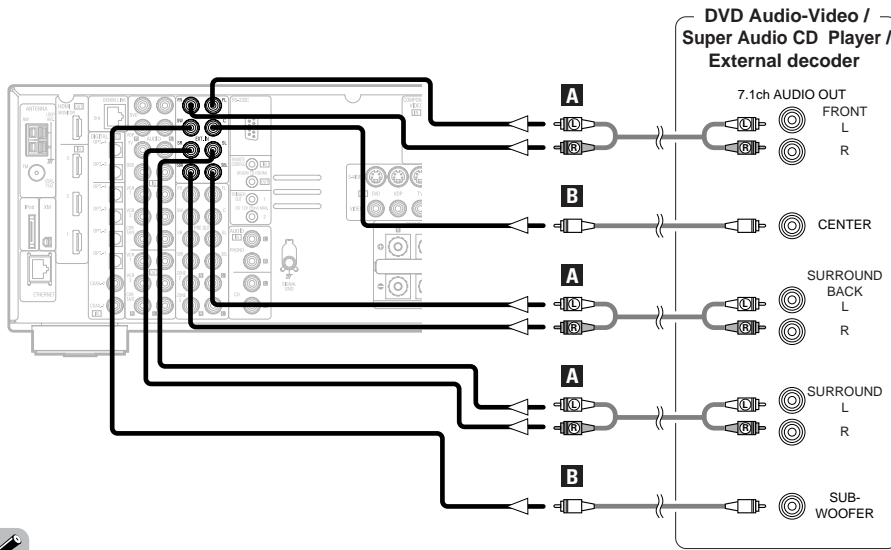

- With discs on which special copyright protection measures have been taken, however, the digital signals may not be output from the DVD player. In this case, connect the DVD player's analog multi-channel output to the AVR-4306's EXT. IN terminals for playback. Also refer to your DVD player's operating instructions.

### Connecting a video camera component or video game

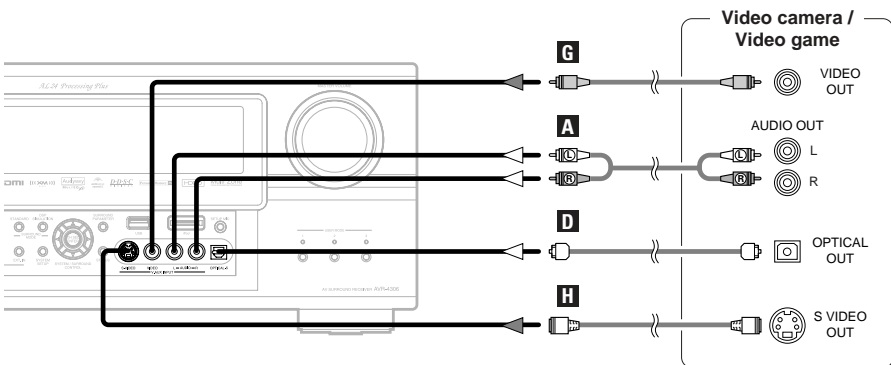

## Connecting Other Sources

### Connecting a CD player

To connect the digital audio output from the CD player, you can choose from either the coaxial or optical connections. If you choose to use the optical connection, it needs to be assigned. For more information about Digital Input Assignment (page 67).

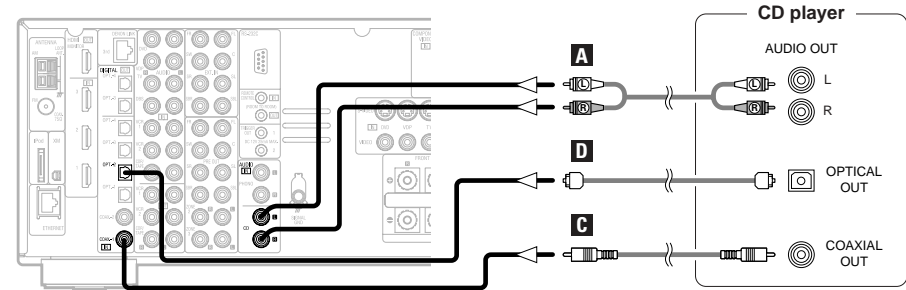

### Connecting a turntable

You can connect the turntable (MM cartridge) to the PHONO terminals.

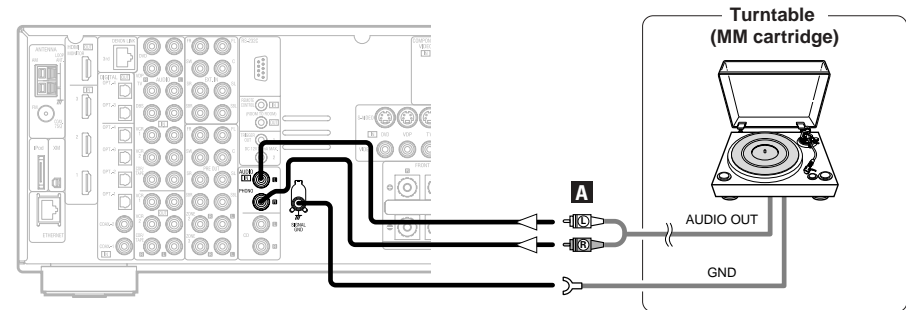

#### NOTE:

- The phono input can accept signals from moving magnet (MM) and high output moving coil (MC) phono cartridges. If your turntable is equipped with a low output MC cartridge, you will need to use a separate MC head amplifier or step-up MC transformer.
- If humming or other noise is generated when the ground wire is connected to the SIGNAL GND terminal, disconnect the ground wire.

Connecting a VCR

There are two sets of video deck (VCR) terminals, so two video decks can be connected for simultaneous recording or video copying.

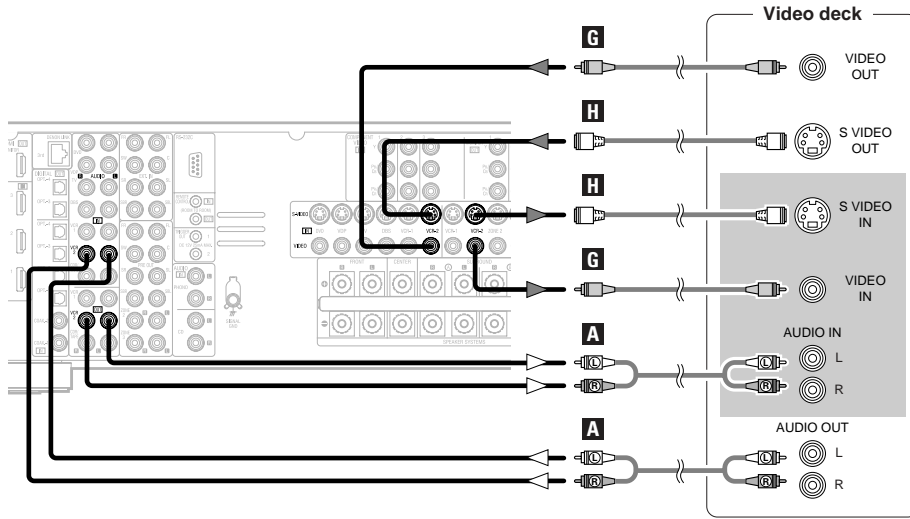

NOTE:

• When recording to a VCR, it is necessary that the type of cable used with the playback source equipment be the same type that is connected to the AVR-4306 VCR-1 (to 2) OUTPUT terminal.

**Example:** VCR-2 IN → S-Video cable : VCR-2 OUT → S-Video cable  
 VCR-2 IN → Video cable : VCR-2 OUT → Video cable

Connecting a DVD recorder

- For best picture quality choose the component video connection to your DVD recorder. S-Video and composite video outputs are also provided. If you choose to use the component video connection, it needs to be assigned. For more information about Component Input Assignment (page 71, 72).
- If you wish to perform analog dubbing from a digital sources, such as a DVD recorder to an analog recorder such as a cassette deck, you will needs connect the analog inputs and outputs as shown below, in addition to the digital audio connections.

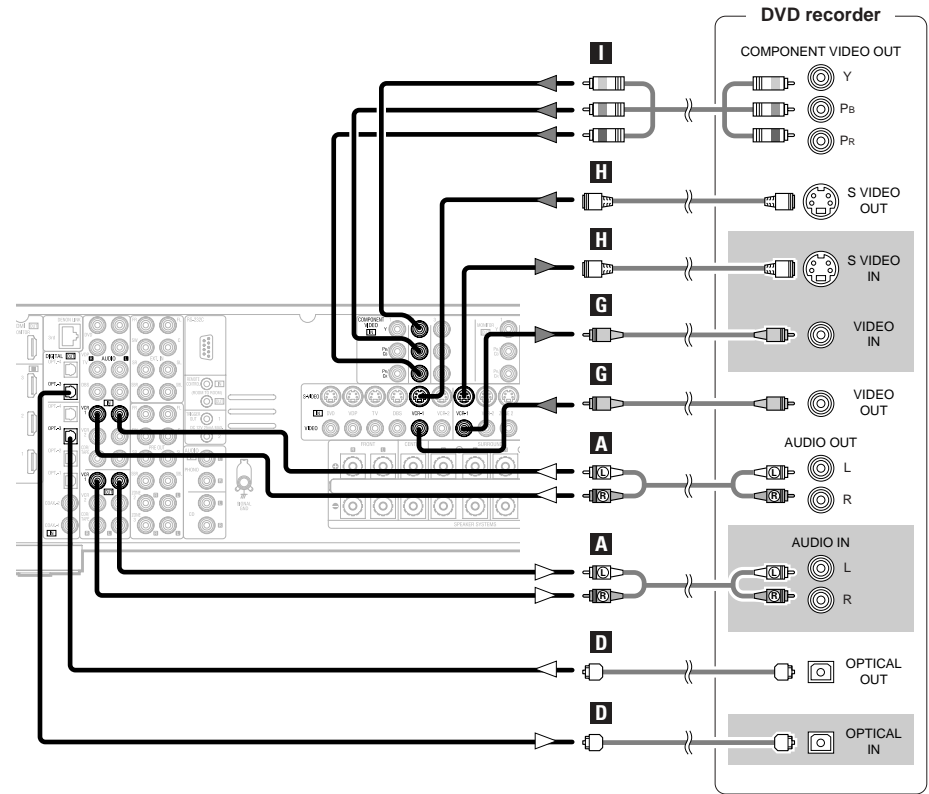

NOTE:

• When recording to a DVD recorder, it is necessary that the type of cable used with the playback source equipment be the same type that is connected to the AVR-4306 VCR-1 (to 2) OUTPUT terminal.

**Example:** VCR-1 IN → S-Video cable : VCR-1 OUT → S-Video cable  
 VCR-1 IN → Video cable : VCR-1 OUT → Video cable

• Do not connect the output of the component connected to the OPTICAL 3 OUT terminal on the AVR-4306's rear panel to any terminal other than the OPTICAL 3 IN terminal.

Connecting a CD recorder or MD recorder

If you wish to perform analog dubbing from a digital source, such as a CD or MD recorder to an analog recorder such as a cassette deck, you will need to connect the analog inputs and outputs as shown below, in addition to the digital audio connections.

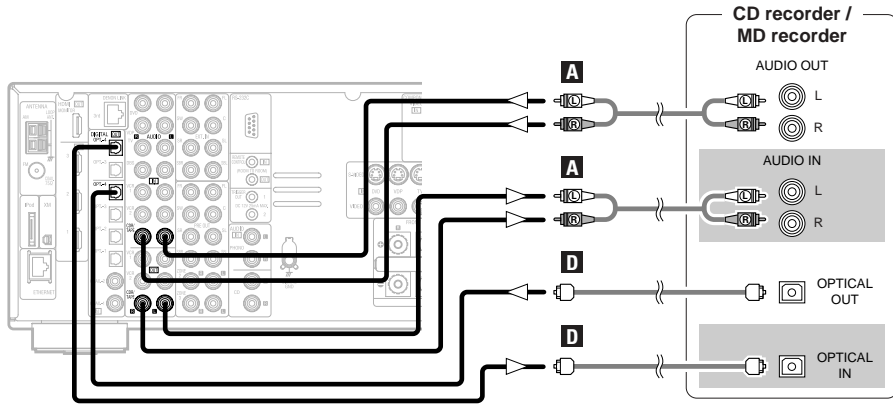

NOTE:

- Do not connect the output of the component connected to the OPTICAL 4 OUT terminal on the AVR-4306's rear panel to any terminal other than the OPTICAL 4 IN terminal.

Connecting a tape deck

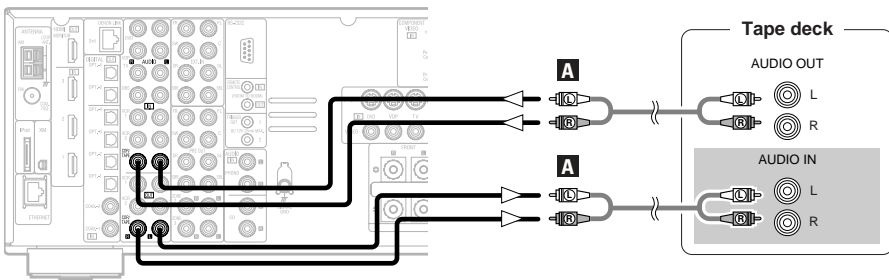

DENON LINK connection

- High quality digital sound with reduced digital signal transfer loss can be enjoyed by connecting a separately sold DENON LINK compatible DVD player.
- Digital transfer and multi-channel playback of DVD-Audio discs, Super Audio CDs and other multi-channel sources are possible by connecting the AVR-4306 to a DENON DVD player equipped with a DENON LINK connector using the connection cable included with the DVD player. For instructions on playing Super Audio CDs (page 63).
- When a DENON DVD player and the DENON LINK have been connected, be sure to make a setting to "DENON LINK" with "Setting the Digital In Assignment" (page 67).

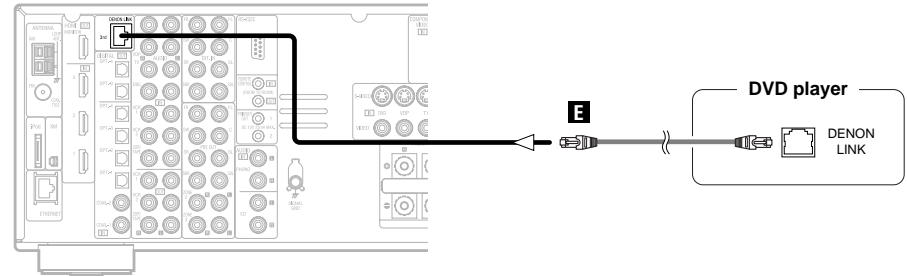

- With discs on which special copyright protection measures have been taken, however, the digital signals may not be output from the DVD player. In this case, connect the DVD player's analog multi-channel output to the AVR-4306's EXT. IN terminals for playback. Also refer to your DVD player's operating instructions.



**Connecting equipment with HDMI (High-Definition Multimedia Interface) terminals**

- A simple 1-cable connection (using a commercially available cable) with a device having an HDMI (High-Definition Multimedia Interface) connector allows digital transfer of the digital images of DVD video and other sources, and the multi-channel sound of DVD Audio and DVD Video.
- To provide audio output from AVR-4306's audio output connector, select "Amp" at the System Setup. To provide audio output from the TV, select "TV" at the System Setup. For details, see "Setting the HDMI In Assign" (page 71).

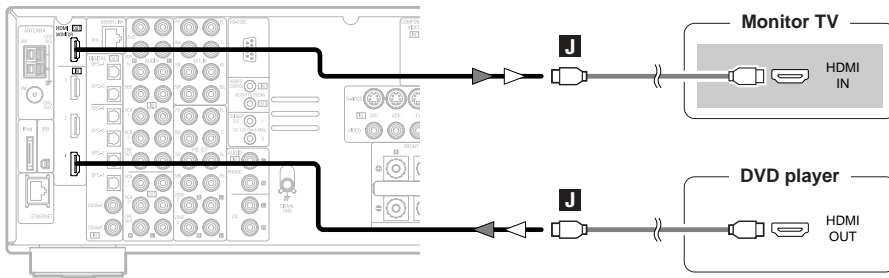

Input signals		
DVD Video	LINEAR PCM	○
	Dolby Digital	○
	DTS	○
DVD Audio	LINEAR PCM PACKED PCM (with CPPM / without CPPM)	○
	CD	○
Super Audio CD	LINEAR PCM	○
	Multi area	×
	Stereo area	×
	CD area	○

※ The AVR-4306 is HDMI Ver. 1.1 compatible.

**Copyright Protection System**

To play back the digital video and audio of DVD video and DVD audio through an HDMI/DVI-D connection, both the connected player and monitor are required to support a copyright protection system called HDCP (High-bandwidth Digital Content Protection System). HDCP is copy protection technology that comprises data encryption and authentication of the partner equipment.

The AVR-4306 supports HDCP. Please see the user's manual of your video display for more information about this.

**NOTE:**

- The audio signals on the multi/stereo area of Super Audio CDs are not output. If the Super Audio CD is a hybrid CD, only the audio signals in the CD area are output.
- Use a compatible player to play DVD-Audio discs that are copyright protected by CPPM.
- Among the devices that support HDMI, some devices can control other devices via the HDMI connector; however, the AVR-4306 cannot be controlled by another device via the HDMI connector.
- The audio signals from the HDMI connector (including the sampling frequency and bit length) may be limited by the equipment that is connected.
- The video signals are not output properly if a device not compatible with HDCP is used.
- When "Through" is set at "Resolution" under "Setting the HDMI Out Setup", use a monitor compatible with input resolutions of 480i/576i.
- The video signals input from the HDMI input terminals are output to the HDMI monitor with their original resolution, so the image will not be displayed if the resolutions of the input signal and the monitor being used are not matched. In this case, change the setting of the resolution on the source device (player) to one which the monitor can handle.
- For stable signal transfer, we recommend using cables that are a maximum of 5 meters in length.



- If your digital TV monitor or DVD player only supports DVI-D, please obtain and use an HDMI-DVI conversion cable or adaptor, available from your dealer.

**Connections with an HDMI/DVI-D conversion cable (adaptor)**

- The HDMI video stream signals (video signals) are theoretically compatible with DVI-D. When connecting to a monitor, etc., equipped with DVI-D terminals, it is possible to connect using an HDMI/DVI-D conversion cable, but depending on the combination of devices used the image might not be output.
- When using an HDMI/DVI-D conversion adapter, the image may not be output properly due to poor contact with the connected cable, etc..

**Connecting the antenna terminals**

An F-type FM antenna cable plug can be connected directly.

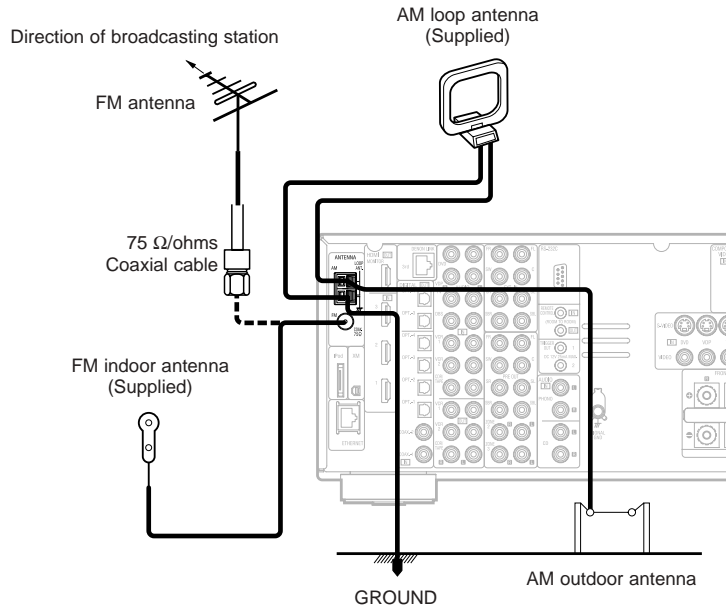

**AM loop antenna assembly**

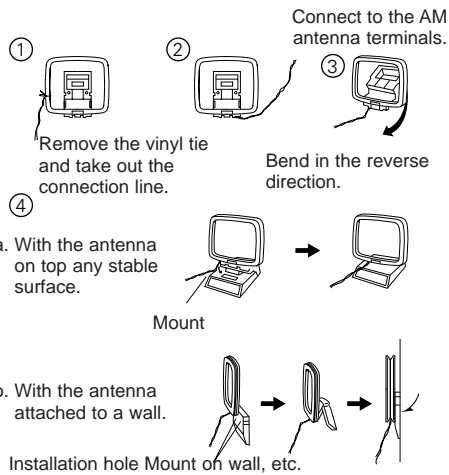

**Connection of AM antennas**

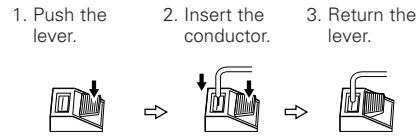

**NOTE:**

- Do not connect two FM antennas simultaneously.
- Even if an external AM antenna is used, do not disconnect the AM loop antenna.
- Make sure the AM loop antenna lead terminals do not touch metal parts of the panel.

**Note to CATV system installer:**  
This reminder is provided to call the CATV system installer's attention to Article 820-40 of the NEC which provides guidelines for proper grounding and, in particular, specifies that the cable ground shall be connected to the grounding system of the building, as close to the point of cable entry as practical.

**Connecting the XM terminal**

- AVR-4306 is the XM Ready® receiver. You can receive XM Satellite Radio® by connecting to the XM Connect-and-Play™ (sold separately) and subscribing the XM service.
- Plug the XM Connect-and-Play antenna into XM terminal on the rear panel.
- Position the XM Connect-and-Play antenna near a south-facing window to receive the best signal. For details, see "XM Satellite Radio" (page 42).  
When making connections, also refer to the operating instructions of the XM Connect-and-Play antenna.

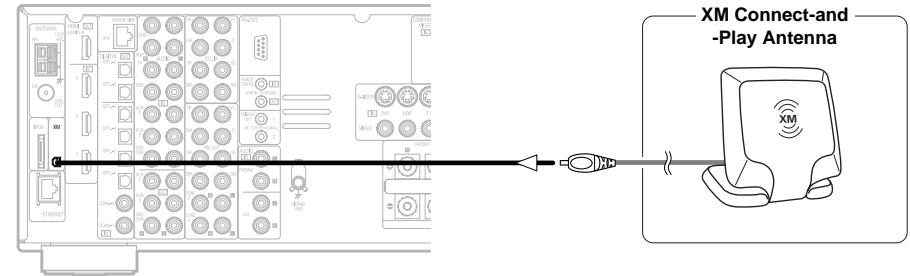

**NOTE:**

- Keep the power supply cord unplugged until the XM Connect-and-Play antenna connection have been completed.

Connecting the RS-232C terminal

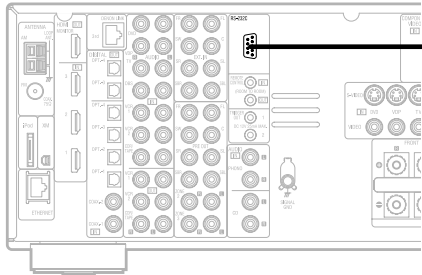

This terminal is used for an external controller only (Do not connect to computers).  
 Perform the following operation before using an external controller connected to the RS-232C terminal:

1. Press the **ON/STANDBY** button on the main unit and set the unit to the operating mode.
2. Perform the operation to turn off the power from the external control.
3. Check that the product has been set to the standby mode.

After checking the above, check the connections of the external controller. Operation is possible.

Connecting the TRIGGER OUT terminals

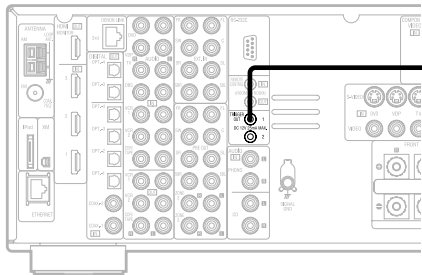

Turn the DC 12V voltage on and off for the individual functions and surround modes.  
 For details, see "Setting the Trigger Out" (page 77, 78).

Connecting the MULTI ZONE terminals

※ For instructions on operations using the MULTI ZONE functions (page 60 ~ 62).

ZONE2 (or ZONE3) pre-out connections

- If another power amplifier or pre-main (integrated) amplifier is connected, the ZONE2 (or ZONE3) pre-out (variable or fixed level) terminals can be used to play a different program source in ZONE2 (or ZONE3) the same time (page 60).
- The ZONE2 video out is only for the ZONE2.
- When a sold separately room-to-room remote control unit (DENON RC-616, 617 or 618) is wired and connected between the MAIN ZONE and ZONE2 (ZONE3), the remote-controllable devices in the MAIN ZONE can be controlled from ZONE2 (ZONE3) using the remote control unit.

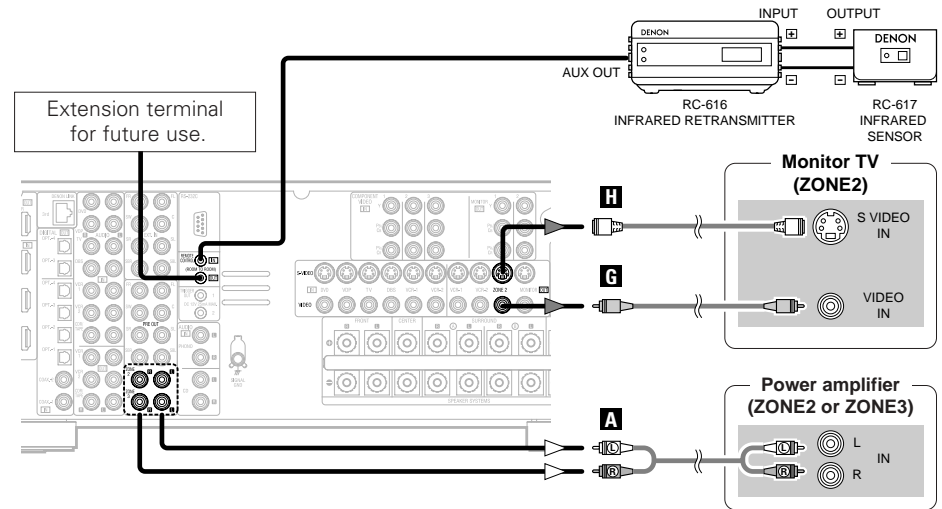

NOTE:

- For the AUDIO output, use high quality pin-plug cables and wire in such a way that there is no humming or noise.
- For instructions on installation and operation of separately sold devices, refer to the devices' operating instructions.

**ZONE2 / ZONE3 speaker out connections**

- When the surround back's power amplifier is assigned to the ZONE2 or ZONE3 output channel at "Power Amp Assign" in the "System Setup Menu", the surround back speaker terminals can be used as the ZONE2 or ZONE3 speaker out terminals (see page 61).
- The connections diagram below is an example for when the surround back speaker is assigned to the ZONE2 stereo 2 channel. In this case, surround back speaker out can not be used for MAIN ZONE.

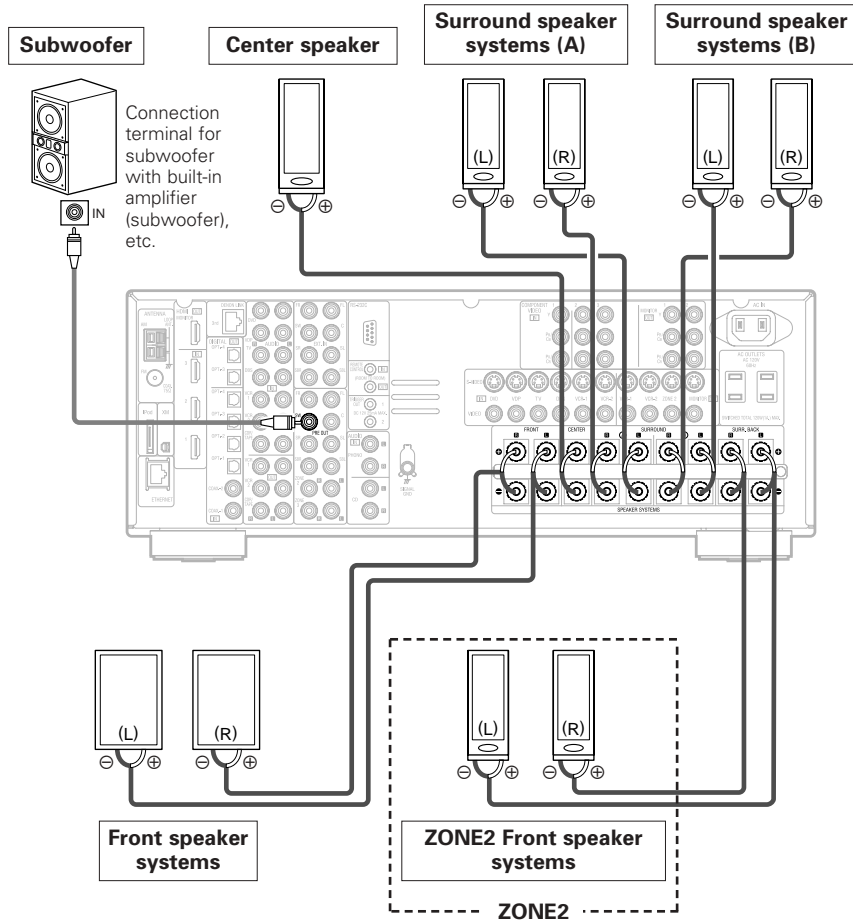

**Connecting the pre-out terminals**

- Use these terminals if you wish to connect external power amplifier(s) to increase the power of the front, center, surround and surround back sound channels, or for connection to powered loudspeakers.
- When using only one surround back speaker, connect it to the left channel.

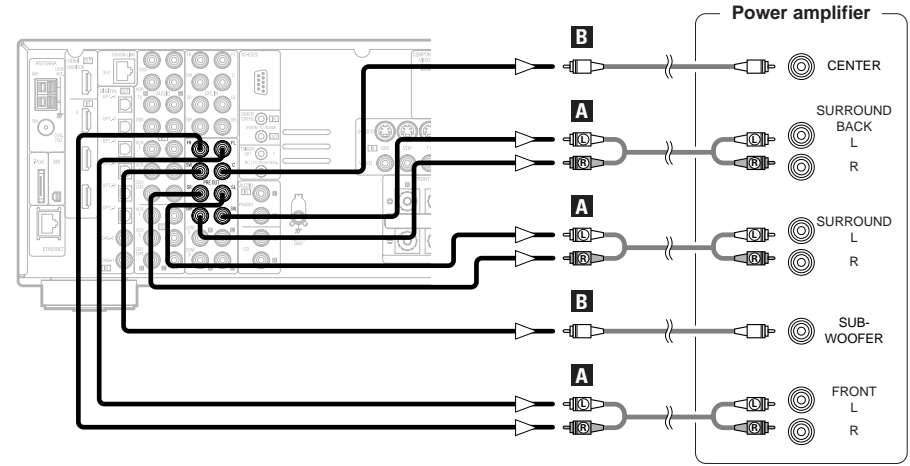

**Connecting the power supply cord**

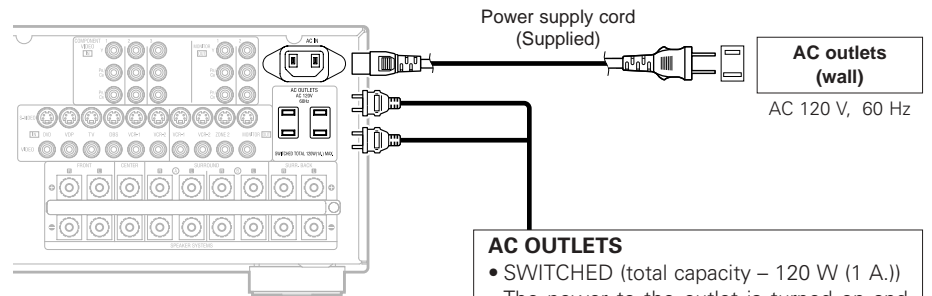

**NOTE:**

- Only use the AC OUTLETS for audio equipment. Never use it for hair driers, TVs or other electrical appliances.
- Insert the plugs securely. Incomplete connections will result in the generation of noise.

**AC OUTLETS**

- **SWITCHED** (total capacity – 120 W (1 A.))  
The power to the outlet is turned on and off in conjunction with the **POWER** switch on the main unit, and when the power is switched between on and standby from the remote control unit. No power is supplied from this outlet when this unit's power is at standby. Never connect equipment whose total power consumption exceeds 120 W (1 A.).

# Basic Operation

## Playback

### Operating the remote control unit

The RC-1024 remote control has a backlit EL display whose contents change according to the mode or function selected, with the appropriate remote commands for that mode or function.

### Operate the this unit

The **AMP** button is the main mode for controlling the AVR-4306 in the main room (MAIN ZONE).

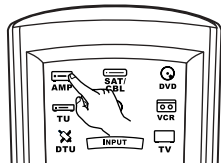

※ The function switches as shown below each time one of the **AMP** button is pressed.

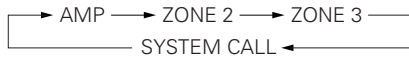

※ The EL display switches as shown below with respect to the selected mode.

### AMP mode

To operate the MAIN ZONE function.

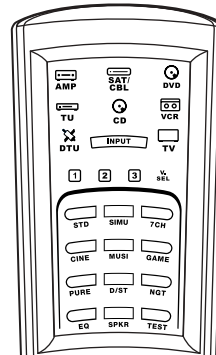

### ZONE2 mode

To operate the ZONE2 function.

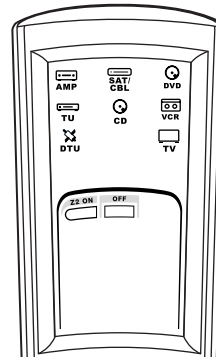

### ZONE3 mode

To operate the ZONE3 function.

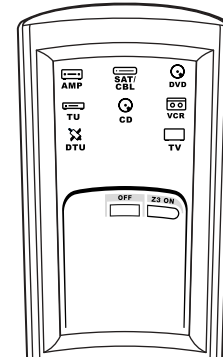

### SYSTEM CALL mode

To operate the "System call" function.

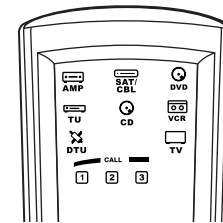

- This function provides the ability to program a series of individual remote control codes into a macro stored under one of the number pad's numeric choices (see page 57).

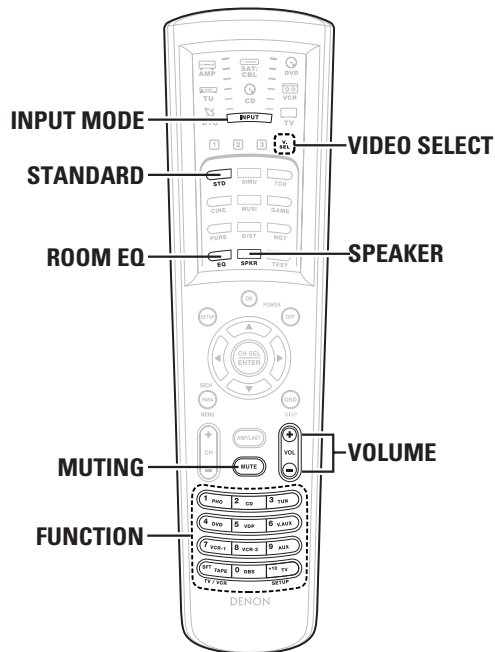
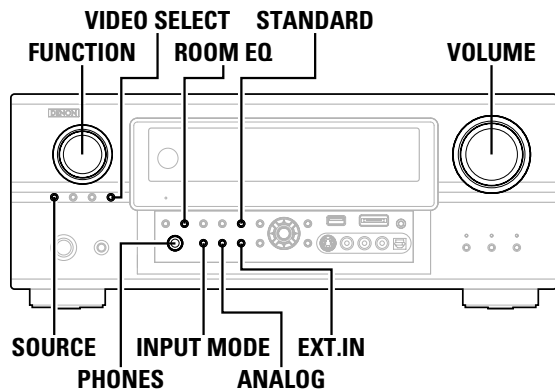

### Playing the input source

#### 1 Select the input source to be played.

Example: CD

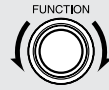

(Main unit)

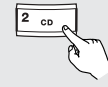

(Remote control unit)

※ To select the input source when ZONE2/3/REC SELECT, VIDEO SELECT or TUNING PRESET is selected, press the **SOURCE** button on the main unit then operate the **FUNCTION** knob.

#### ■ To choose the surround sound mode

Example: Dolby Digital

Press the **STANDARD** button.

※ For more information about the surround modes (page 31, 32).

#### ■ To select the Room EQ function

Press the **ROOM EQ** button.

※ For more information about the Room EQ function (page 28).

#### 2 Start playback on the selected component.

※ For operating instructions, refer to the component's manual.

#### 3 Adjust the volume.



(Main unit)



(Remote control unit)

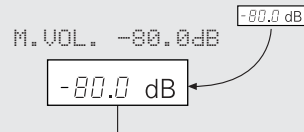

The volume level is displayed on the master volume level display.

※ The volume can be adjusted within the range of -80 to +18 dB, in steps of 0.5 dB. However, when the channel level is set (page 39 or 77), if the volume for any channel is set at +0.5 dB or greater, the volume cannot be adjusted up to 18 dB. (In this case the maximum volume adjustment range is "18 dB — (Maximum value of channel level)".)

※ Also, you may not be able to adjust the volume to the maximum of 18 dB when internal volume compensation control is activated due to the combination of the surround mode and parameters, downmixing from multi-channel audio signals into two channels, etc.

**Playback using the external input (EXT. IN) terminals**

Press the **EXT. IN** button on the main unit or **INPUT MODE** button on the remote control unit to switch the external input.

When operating the remote control unit:

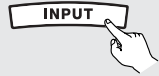

(Remote control unit)

※ The mode switches as shown below each time the **INPUT MODE** button is pressed:

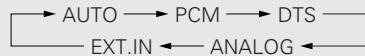

- Cancelling the external input mode:  
Press the **INPUT MODE** or **ANALOG** button to switch to the desired input mode (☞ page 27, 28).
- The external input mode can be set for any input source. To watch video while listening to sound, select the input source to which the video signal is connected, then set this mode.
- If the subwoofer output level seems too high, set the “SW ATT” surround parameter to “ON”.

**NOTE:**

- When the input mode is set to the external input (EXT. IN), the surround mode (DIRECT, STEREO, STANDARD, 7CH STEREO, WIDE SCREEN or DSP SIMULATION) cannot be set.
- In play modes other than the external input mode, the signals connected to these terminals cannot be played. In addition, signals cannot be output from channels not connected to the input terminals.

**Turning the sound off temporarily (MUTING)**

Use this to mute the audio output temporarily.

Press the **MUTING** button.

- You can adjust the muting level (☞ page 77).



• Cancelling MUTING mode:

Press the **MUTING** button again, or press the **VOLUME** button on the remote control, or adjust the volume up or down via the front panel **VOLUME** knob.

**Listening over headphones**

Connect the headphones to the **PHONES** jack.

- The pre-out output (including the speaker output) is automatically turned off when headphones are connected.

**NOTE:**

- To prevent hearing loss, be careful not to raise the volume level excessively when using headphones.

**Combining the currently playing sound with the desired image (VIDEO SELECT)**

Operate the video select from the main unit

Press the **VIDEO SELECT** button, turn the **FUNCTION** knob until the desired image appears on the display.



(Main unit)

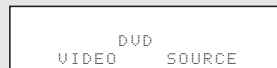

- ※ The video source selected with the video select function is stored in the memory for the different input sources.

Operate the video select from the remote control unit

Press the **VIDEO SELECT** button until the desired image appears.



- Cancelling simulcast playback:  
Select “SOURCE” pressing the **VIDEO SELECT** button.
- It is not possible to select HDMI input signals.
- When playing HDMI video input signals, the analog video signal of another function cannot be selected for the HDMI video output.

**Switching the surround speakers**

Press the **SPEAKER** button.

- ※ The surround speakers switch as shown below each time the **SPEAKER** button is pressed.

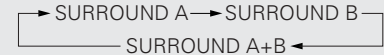

- ※ This operation is possible when the setting for using both surround speakers A and B is made at “Setting the type of speakers” (☞ page 82).



- When using the pre-out terminals, set to either “A” or “B”.

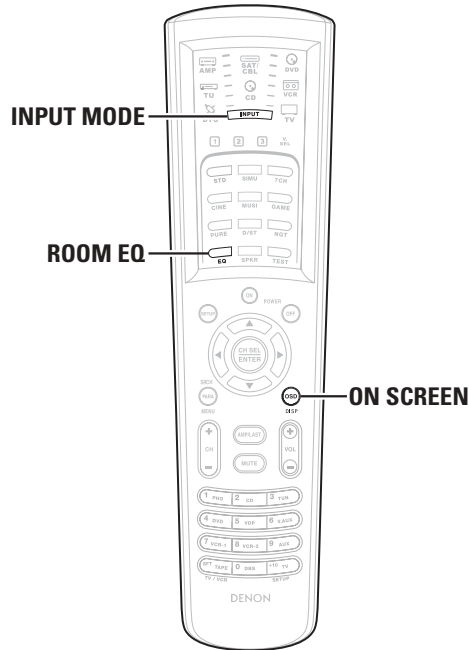
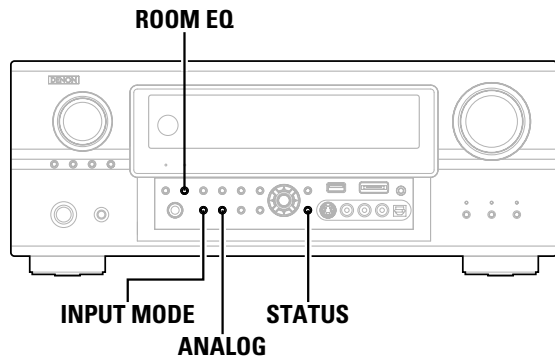

**Checking the currently playing program source, etc.**

**On screen display**

Press the **ON SCREEN** button.

- ※ Each time an operation is performed, a description of that operation appears on the display connected to AVR-4306's VIDEO MONITOR OUT terminal. Also, the unit's operating status can be checked during playback.
- ※ Such information as the position of the input selector and the surround settings is output in sequence.

**Front panel display**

Press the **STATUS** button.

- ※ Descriptions of the unit's operations are also displayed on the front panel display. In addition, the display can be switched to check the unit's operating status while playing a source.

**Input mode**

The AVR-4306 has an AUTO signal detection mode that automatically identifies the type of incoming audio signals, but is also equipped with a manual mode that can be switched according to the type of input audio signals.

**Selecting the AUTO, PCM and DTS modes**

Press the **INPUT MODE** button.

- ※ The mode switches as shown below each time the **INPUT MODE** button on the main unit is pressed:



When operating the remote control unit:

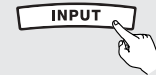

(Remote control unit)

- ※ The mode switches as shown below each time the **INPUT MODE** button on the remote control unit is pressed:

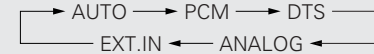

**AUTO** (All auto mode):

In this mode, the types of signals being input to the digital and analog input terminals for the selected input source are detected and the program in the AVR-4306's surround decoder is selected automatically upon playback. This mode can be selected for all input sources other than PHONO and TUNER.

The presence or absence of digital signals is detected, the signals input to the digital input terminals are identified and decoding and playback are performed automatically in DTS, Dolby Digital or PCM (2 channel stereo) format. If no digital signal is being input, the analog input terminals are selected. Use this mode to play Dolby Digital signals.

**PCM** (exclusive PCM signal playback mode):

Decoding and playback are only performed when PCM signals are being input. Note that noise may be generated when using this mode to play signals other than PCM signals.

**DTS** (exclusive DTS signal playback mode):

Decoding and playback are only performed when DTS signals are being input.



■ Selecting the analog mode

Press the **ANALOG** button on the main unit or **INPUT MODE** button on the remote control unit to switch to the analog input.

**ANALOG** (exclusive analog audio signal playback mode):  
The signals input to the analog input terminals are decoded and played.

**NOTE:**

- Input mode when playing DTS sources:  
Noise will be output if DTS-compatible CDs or LDs are played in the "ANALOG" or "PCM" mode.  
When playing DTS-compatible sources, be sure to connect the source component to the digital input terminals (OPTICAL/COAXIAL) and set the input mode to "DTS".

■ Input mode display

Depending on the input signal.

- In the AUTO mode
 

AUTO	PCM	DTS
ANALOG	EXT.IN	
- In the DIGITAL PCM mode
 

AUTO	PCM	DTS
ANALOG	EXT.IN	
- In the DIGITAL DTS mode
 

AUTO	PCM	DTS
ANALOG	EXT.IN	
- In the ANALOG mode
 

AUTO	PCM	DTS
ANALOG	EXT.IN	
- In the EXT.IN mode
 

AUTO	PCM	DTS
ANALOG	EXT.IN	

■ Input signal display

- DOLBY DIGITAL
 

DIGITAL	AAC
DSD	PCM
DIG.	HDCCD

  - Depending on the input signal.
  - The "DSD" indicator lights when the DENON LINK have been connected and the DSD signals have been input (🔊 page 19).
- DTS
 

DIGITAL	AAC
DSD	PCM
DIG.	HDCCD

  - Depending on the input signal.
  - The "HDCCD" indicator lights when digital signals are being input with a player that supports HDCCD playback.
- PCM
 

DIGITAL	AAC
DSD	PCM
DIG.	HDCCD

  - Depending on the input signal.
  - The "DIG." indicator lights when digital signals are being input properly. If the "DIG." indicator does not light, check whether the "Digital In Assign" (🔊 page 67) and connections are correct and whether the component's power is turned on.
  - AL24 processing is activated when PCM signals are played while the surround mode is set to PURE DIRECT, DIRECT, STEREO, MULTI CH PURE DIRECT, MULTI CH DIRECT or MULTI CH IN.

**NOTE:**

- The "DIG." indicator will light when playing CD-ROMs containing data other than audio signals, but no sound will be heard.

**Room EQ function**

The AVR-4306's Auto Setup / Room EQ function offers three correction curves: "Audyssey", "Front", "Flat". The timbre of the speakers can also be adjusted manually using a graphic equalizer. Details of the different correction curves are described below.

**Press the ROOM EQ button.**

- The "Audyssey" is selected, the MultEQ XT indicator lights green.
- The "Front" or "Flat" is selected, the MultEQ XT indicator lights red.  
The MultEQ XT indicator also lights red if the "Speaker Configuration", "Distance", "Channel Level" or "Crossover Frequency" is set manually after conducting the Auto Setup procedure.
- The Room EQ switches as follows each time the **ROOM EQ** button is pressed.

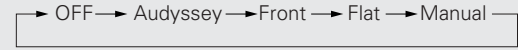

**Audyssey:**  
This adjusts the frequency response of all speakers to correct the effects of room acoustics.

**Front:**  
This adjusts the characteristics of each speaker to the characteristics of the front speakers.

**Flat:**  
This the frequency response of all speakers flat.  
This is suitable for multi-channel music reproduction, from discrete music sources such as Dolby Digital 5.1, DTS, DVD-Audio and Super Audio CD.

**Manual:**  
Selects the setting value that was set in the Manual EQ Setup.  
For details of the "Setting the Manual EQ Setup" (🔊 page 75).

- The "Audyssey", "Front" and "Flat" Room EQ curves can be selected after performing the Auto Setup procedure.

**Surround**

**Playing modes for different sources**

The AVR-4306 is equipped with many surround modes. We recommend using the surround modes as described below in order to achieve the maximum effect for the specific signal source.

\*  is a 6.1-channel/7.1-channel surround mode.

**Sources recorded in Dolby Digital EX**

**DOLBY DIGITAL EX / +PLIIx\*1**

(page 31)

- This mode is optimized for playing sources recorded in Dolby Digital EX.

**Sources recorded in DTS-ES**

**DTS-ES DSCRT 6.1 / MTRX 6.1, +PLIIx\*1**

(page 31)

- This is the optimum mode for playing sources recorded in DTS-ES.

**Dolby Digital or DTS Surround (5.1 ch sources) 2 ch sources recorded in Dolby Surround**

**WIDE SCREEN** (page 36 ~ 38)

- Effective for 2-channel sources recorded in Dolby Surround or for 7.1-channel playback with 5.1-channel sources.

**DOLBY DIGITAL / DOLBY DIGITAL+PLIIx\*1 / DTS SURROUND / DTS 96/24 / DTS+PLIIx\*1 / DTS+NEO:6**

(page 31)

- This mode is optimized for playing 5.1-channel or 7.1-channel music.
- For Dolby Surround recording sources, Dolby Pro LogicII playback is conducted.

**Sources recorded in stereo Sources recorded in monaural**

**PURE DIRECT** (page 30)

- By suspending all circuits and processes not required, analog input music playback can be played with optimum quality.

**DIRECT / STEREO** (page 30)

- Effective for achieving pure playback.
- If there is no need for tone control or distribution of the low frequencies in function of the speaker configuration, select the DIRECT mode to achieve the best sound quality.

**DENON Original Surround Modes**

(page 36 ~ 38)

- Select these for 7.1-channel playback with sources recorded in stereo or monaural.
- The effects are different for each of the surround modes. Select the one most suited for the source being used.

**DTS NEO:6** (page 35)

- This is a surround mode for playing 6.1- or 7.1-channel stereo sources developed by Digital Theater Systems.
- One of two playing modes, MUSIC (for music sources) or CINEMA (for movie sources), can be selected according to your preferences.

**DOLBY PRO LOGICIIx\*1**

(page 33, 34)

- Developed by Dolby Laboratories, this surround mode provides 7.1 channel surround sound with conventional stereo (2-channel) sources.
- Select CINEMA mode for movie surround soundtracks, MUSIC for music sources, and GAME for 2-channel game box audio sources.



- Though we recommend selecting the surround mode as described above, other surround modes can also be selected.

**NOTE:**

- Surround modes marked with an asterisk (\*1) cannot be used when the surround back speaker is set to "NONE".
- The "+PLIIx Cinema" mode cannot be selected when only one surround back speaker is being used.

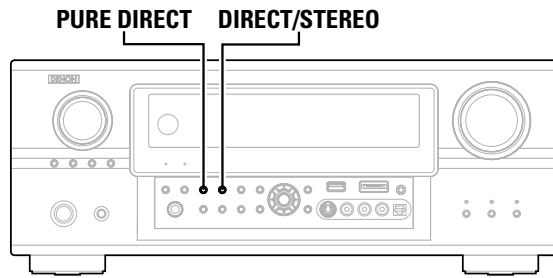

**Playing audio sources (CDs and DVDs)  
2-channel playback modes**

- The AVR-4306 is equipped with three 2-channel playback modes exclusively for music.
- Select the mode to suit your tastes.

**■ PURE DIRECT mode**

This mode reproduces the sound with extremely high quality. When this mode is set, all circuits and processes not required for the selected input source (FL tube, video circuit and tone control, as well as digital circuitry and other unnecessary circuits for analog audio inputs) are automatically turned off so the music signals can be reproduced with high sound quality.

**Press the PURE DIRECT button to select the PURE DIRECT mode.**

**■ DIRECT mode**

Use this mode to achieve good quality 2-channel sound. In this mode, the audio signals bypass such circuits as the tone circuit and are transmitted directly, resulting in good quality sound.

**Press the DIRECT/STEREO button to select the DIRECT mode.**

※ The mode switches as shown below each time the **DIRECT/STEREO** button is pressed.

DIRECT ← → STEREO

**■ STEREO mode**

Use this mode to adjust the tone and achieve the desired sound.

**Press the DIRECT/STEREO button to select the STEREO mode.**



- The system setup function cannot be used when the PURE DIRECT mode is set. To use the system setup function, cancel the PURE DIRECT mode.
- If the HDMI input terminal is selected, video outputs are outputted in the PURE DIRECT mode.
- The channel level and surround parameters in the PURE DIRECT mode are the same as in the DIRECT mode.

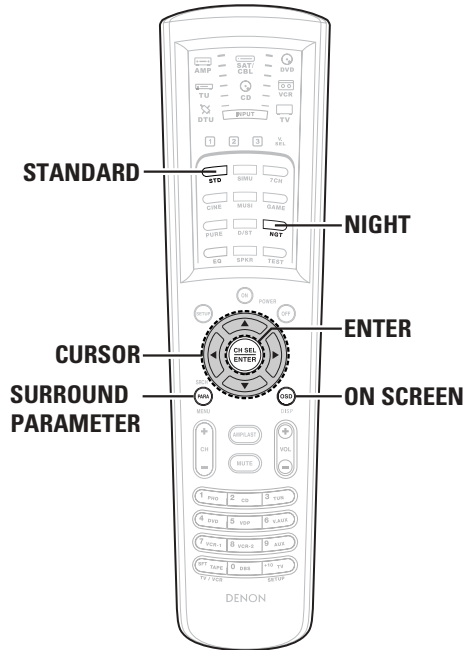
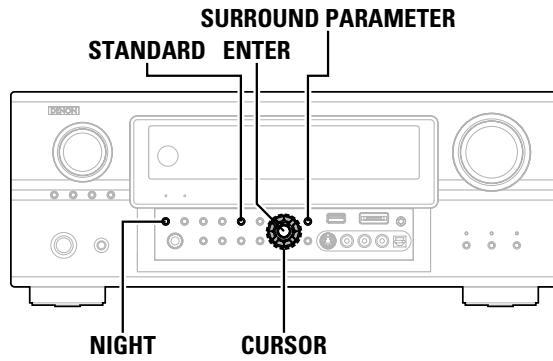

**Dolby Digital mode and DTS Surround (only with digital input)**

**1** Press the **STANDARD** button to select “STANDARD (Dolby/DTS Surround)” mode.

**2** Play a program source with the

- The Dolby Digital indicator lights when playing Dolby Digital sources.
- The DTS indicator lights when playing DTS sources.



**3** Press the **SURROUND PARAMETER** button.

- The surround parameter menu is displayed.

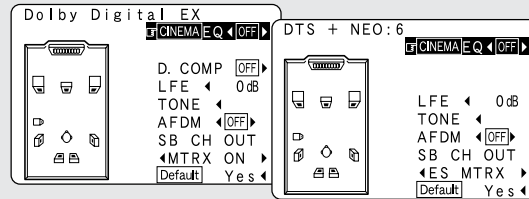

※ The surround back channel can be switched on and off from the surround parameter menu. When the surround back channel is set to “ON”, the surround back channel’s output display lights.

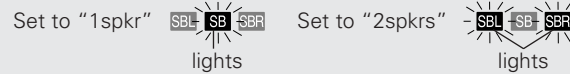

**4** Press the **CURSOR**  $\Delta$  or  $\nabla$  button to select the parameter.

**5** Press the **CURSOR**  $\triangleleft$  or  $\triangleright$  button to select the setting.

**6** Press the **ENTER** or **SURROUND PARAMETER** button to complete the setting.



- When “Default” is selected and the **CURSOR**  $\triangleleft$  button is pressed, “CINEMA EQ.” and “D.COMP.” are automatically turned off, “LFE” is reset, and “TONE” is set to the default value.

**■ Dialogue Normalization**

The dialogue normalization function is activated automatically when playing Dolby Digital program sources. Dialogue normalization is a basic function of Dolby Digital which automatically normalizes the dialog level (standard level) of the signals which are recorded at different levels for different program sources, such as DVD, DTV and other future formats that will use Dolby Digital. When this function is activated, the following message appears on the main unit’s display:

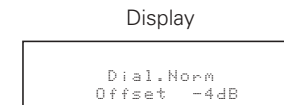

The number indicates the normalization level when the currently playing program is normalized to the standard level.

**Night mode**

When listening at night or at lower volumes, the night mode improves listenability.

**Press the NIGHT button to enter the night mode.**

- The NIGHT indicator lights.
- Canceling night mode: Press the **NIGHT** button again.
- The night mode only works when playing program sources recorded in Dolby Digital.
- When the night mode is set to “ON”, the “D.COMP” surround parameter can not be selected.



**■ Checking the input signal**

The input signal can be checked by pressing the remote control unit's **ON SCREEN** button (⏏ page 5).

**SIGNAL:**

Displays the type of signal (DTS, DOLBY DIGITAL, PCM, etc.).

**fs:**

Displays the input signal's sampling frequency.

**FORMAT:**

Displays the input signal's number of channels.  
 "Number of front channels / Number of surround channels / LFE on/off"  
 "SURROUND" is displayed for 2-channel signal sources recorded in Dolby Surround.

**OFFSET:**

Displays the dialog normalization offset value.

**FLAG:**

Displays the special identification signal recorded in the input signal.  
 "MATRIX" is displayed when matrix processing is conducted on the surround back channel, "DISCRETE" is displayed when discrete processing is conducted.  
 Not displayed when no identification signal is recorded.

• In addition, screen information is displayed in the following order when the **ON SCREEN** button is pressed repeatedly:

- OSD-1 Audio input signal
- OSD-2 Monitor information
- OSD-3 Input/output
- OSD-4 Auto surround mode
- OSD-5 USER MODE 1
- OSD-6 USER MODE 2
- OSD-7 USER MODE 3
- OSD-8~14 Tuner preset stations

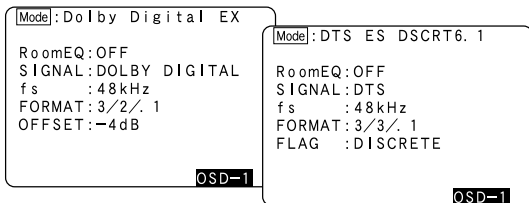

**NOTE:**

- OSD-2: The monitor's resolution is displayed when an HDMI monitor is connected to the AVR-4306.
- OSD-4: This is displayed when the auto surround mode is set to "ON" (⏏ page 75) and the input mode is set to "AUTO". It is not displayed when the input mode is set to "ANALOG" or "EXT. IN".

**■ Surround parameters ①**

**CINEMA EQ.** (Cinema Equalizer):

The Cinema EQ function gently decreases the level of the extreme high frequencies, compensating for overly-bright sounding motion picture soundtracks. Select this function if the sound from the front speakers is too bright.  
 This function only works in the Dolby Pro LogicIIx, Dolby Pro Logic, Dolby Digital, DTS Surround, DTS NEO:6 and WIDE SCREEN modes.

**D.COMP.** (Dynamic Range Compression):

Motion picture soundtracks have tremendous dynamic range (the contrast between very soft and very loud sounds). For listening late at night, or whenever the maximum sound level is lower than usual, the Dynamic Range Compression allows you to hear all of the sounds in the soundtrack (but with reduced dynamic range). (This only works when playing program sources recorded in Dolby Digital or DTS.) Select one of the four parameters ("OFF", "LOW", "MID" (middle) or "HI" (high)). Set to OFF for normal listening.  
 This parameter is displayed only when playing compatible sources in DTS mode.

**LFE** (Low Frequency Effect):

This sets the level of the LFE (Low Frequency Effect) sounds included in the source when playing program sources recorded in Dolby Digital, DTS, DVD-Audio or Super Audio CD.  
 Program source and adjustment range:  
 -10 dB to 0 dB

- \* **When DTS encoded movie software is played, it is recommended that the LFE LEVEL be set to 0 dB for correct DTS playback.**
- \* **When DTS encoded music software is played, it is recommended that the LFE LEVEL be set to -10 dB for correct DTS playback.**

**TONE:**

This adjusts the tone control (⏏ page 38).  
 This can be set individually for the separate surround mode other than PURE DIRECT and DIRECT mode.

**MODE/SB CH OUT:**

Select the surround back channel playback method or mode.

(1) Multi channel source

- **NON MTRX:**  
 The same signals as those of the surround channels are output from the surround back channels.
- **MTRX ON:**  
 The surround channel signals undergo digital matrix processing and are output from the surround back channels.
- **SB OFF (OFF):**  
 No signal is played from the surround back channels.
- **ES MTRX:**  
 When playing DTS signals, the surround back signals undergo digital matrix processing for playback.
- **ES DSCRT:**  
 When a signal identifying the source as a discrete 6.1-channel source is included in the DTS signals, the surround back signals included in the source are played.
- **PLIIx Cinema:**  
 Processing is performed with the Cinema mode of the PLIIx decoder and the Surround Back channel is reproduced.
- **PLIIx Music:**  
 Processing is performed with the Music mode of the PLIIx decoder and the Surround Back channel is reproduced.

(2) 2ch source

- **OFF:**  
 Playback is conducted without using the surround back speaker.
- **ON:**  
 Playback is conducted using the surround back speaker.

**AFDM (Auto Flag Detect Mode):**

• **ON:**

This function only works with software on which a special identification signal is recorded. This software is scheduled to go on sale in the future.

This is a function for automatically playing in the 6.1-channel mode using the surround back speaker(s) if the software is recorded in Dolby Digital EX or DTS-ES or in the normal 5.1-channel mode without using the surround back speaker(s) when the software is not recorded in Dolby Digital EX or DTS-ES.

When AFDM is set to "ON" and the EX/ES flag is detected automatically, the surround mode is fixed according to the playing program source.

In this case, the "MODE/SB CH OUT" parameter can not be selected on the surround parameter screen.

• **OFF:**

When the identification signal is detected automatically and you would like to select the surround mode freely, set AFDM to "OFF".

In this case the "MODE/SB CH OUT" parameter can be selected on the surround parameter screen regardless of the playing program source.

**Example:**When playing software that has a Dolby Digital EX flag

- ① When AFDM is set to "ON", the surround mode is automatically set to the "DOLBY DIGITAL + PLIIx CINEMA" mode. The surround parameter screen will be displayed.

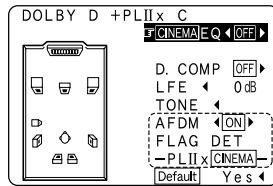

- ② When you would like to play back with the "Dolby Digital EX" mode, set AFDM to "OFF" and select "MTRX ON" with "SB CH OUT".

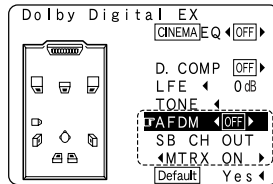

※ Some discs recorded in Dolby Digital EX do not include EX flag. If the playing mode does not switch automatically when the AFDM turns "ON" during playback, manually set "SB CH OUT" to "PLIIx Cinema" or "MTRX ON".

When the surround back speaker is set to "1spkr" at "Speaker Configuration", set "SB CH OUT" to "MTRX ON".

**Dolby Pro LogicIIx (Pro LogicII) mode**

- To play in the PLIIx mode, set "Sp.Back" at the Speaker Configuration setting to "1spkr" or "2spkr".
- To play in the PLIIx mode, set "Surround Back" at the Power Amp Assign setting.

**1 Press the STANDARD button to select "Dolby Pro LogicIIx" mode.**

※ The mode switches as shown below each time the STANDARD button is pressed.

DOLBY PLIIx ← → DTS NEO:6

**2 Play a program source with the DOLBY SURROUND mark.**

※ For operating instructions, refer to the manuals of the respective components.

**3 Press the SURROUND PARAMETER button.**

- The surround parameter menu is displayed.

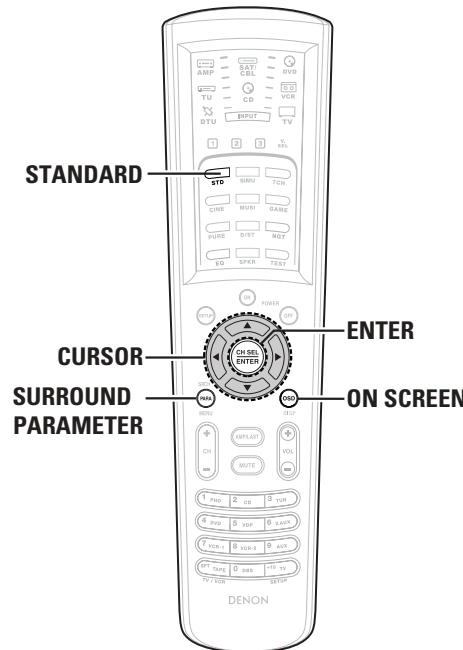
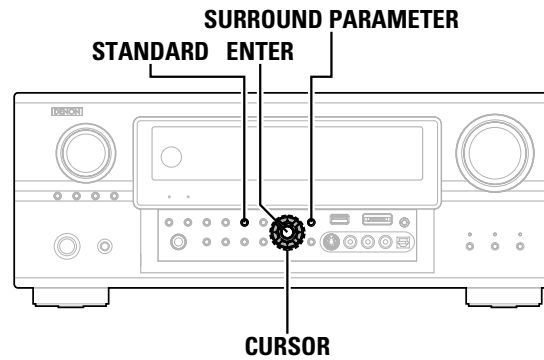
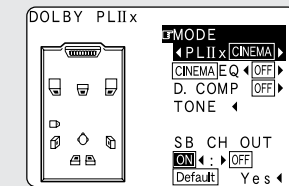

#### 4 Press the **CURSOR** ◀ or ▶ button to select the play mode.

※ When the "SB CH OUT" parameter is set to "ON". (Set "Sp.Back" at the System Setup to "1spkr" or "2spkr").

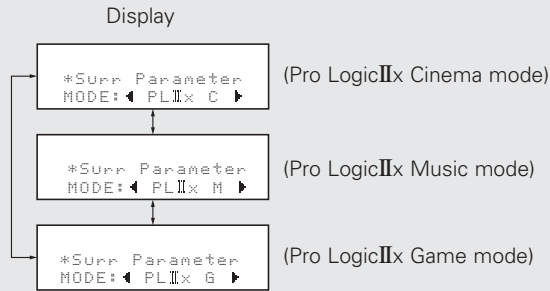

※ When the "SB CH OUT" parameter is set to "OFF". (Set "Sp.Back" at the System Setup to "None").

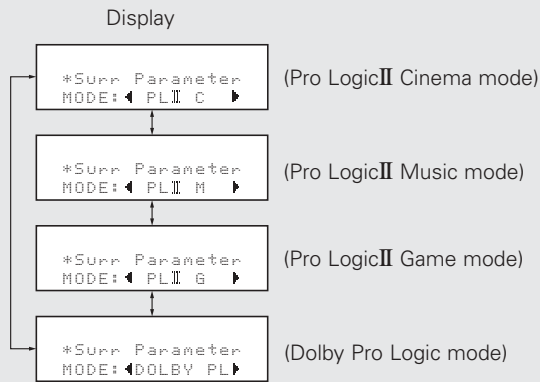

#### ■ Surround parameters ②

##### Pro LogicIIx and Pro LogicII Mode:

Select one of the modes ("Cinema", "Music", "Pro Logic" or "Game").

The Cinema mode is for use with stereo television shows and all programs encoded in Dolby Surround.

The Music mode is recommended for stereo music and surround-encoded stereo music sources.

The Pro Logic mode emulates Dolby Laboratories' original Dolby Pro Logic surround decoding, and may provide better results with older, legacy surround-encoded program material.

The Game mode is optimized for computer and/or dedicated game box consoles, that feature stereo analog or digital outputs. It can only be used with 2-channel stereo sources.

##### PANORAMA:

This mode extends the front stereo image to include the surround speakers for an exciting "wraparound" effect with side wall imaging.

Select "OFF" or "ON".

##### DIMENSION:

This control gradually adjust the soundfield either towards the front or towards the rear.

The control can be set in 7 steps from 0 to 6.

##### CENTER WIDTH:

This control adjust the center image so it may be heard only from the center speaker; only from the left/right speakers as a phantom image; or from all three front speakers to varying degrees.

The control can be set in 8 steps from 0 to 7.

#### 5 Press the **CURSOR** ▲ or ▼ button to select the various surround parameters.

Example: DOLBY PLIIx Music mode screen

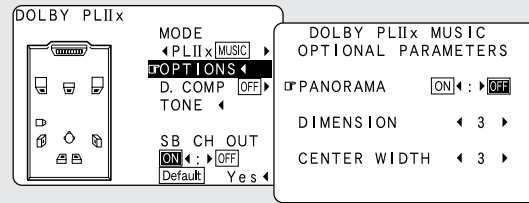

※ When set with the on screen display using the remote control unit while in the MUSIC mode, set the " " mark to "OPTIONS ◀" pressing the **CURSOR** ▲ or ▼ button, then press the **CURSOR** ◀ button.

Press the **ENTER** button to return to the previous screen.

#### 6 Press the **CURSOR** ◀ or ▶ button to adjust the parameters setting.

※ **DEFAULT setting:**

Press the **CURSOR** ◀ button to select "Default Yes ◀", then parameters set to default setting.

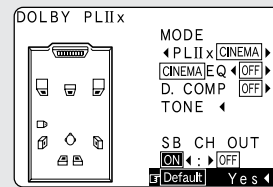

#### 7 Press the **ENTER** or **SURROUND PARAMETER** button to complete the setting.



- There are four Dolby Surround Pro Logic modes (NORMAL, PHANTOM, WIDE and 3 STEREO). The AVR-4306 sets the mode automatically according to the types of speakers set during the system setup process (page 82).

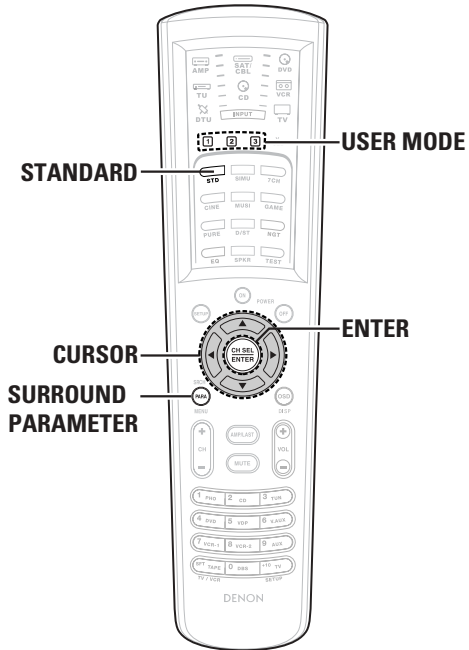
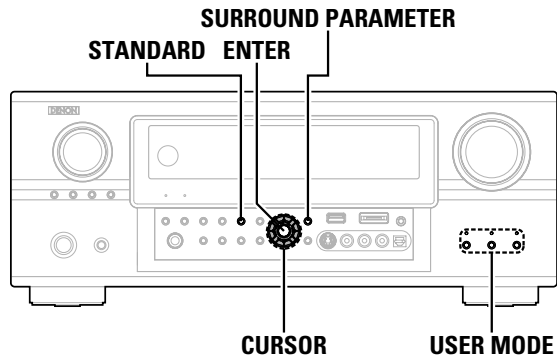

### DTS NEO:6 mode

Surround playback can be performed for the analog input and digital input 2-channel signals.

**1** Press the **STANDARD** button to select “DTS NEO:6” mode.

※ The mode switches as shown below each time the **STANDARD** button is pressed.

DOLBY PLIIx ← → DTS NEO:6

**2** Play a program source.

**3** Press the **SURROUND PARAMETER** button.

- The surround parameter menu is displayed.

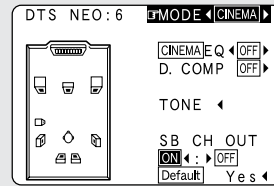

**4** Press the **CURSOR** ◀ or ▶ button to select the play mode.

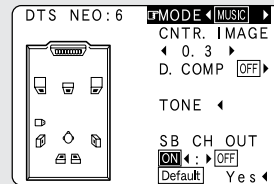

**5** Press the **CURSOR** ▲ or ▼ button to select the various surround parameters.

**6** Press the **CURSOR** ◀ or ▶ button to adjust the parameters setting.

**7** Press the **ENTER** or **SURROUND PARAMETER** button to complete the setting.



- When “Default” is selected and the **CURSOR** ◀ button is pressed, “MODE” and “TONE” are automatically reset to the default values and “CINEMA EQ.” is set to “OFF”.
- When playing PCM digital signals or analog signals in the DOLBY PRO LOGICII, DOLBY PRO LOGICIIx, DTS NEO:6 modes and the input signal switches to a digital signal encoded in Dolby Digital, the Dolby surround mode switches automatically. When the input signal switches to a DTS signal, the mode automatically switches to DTS surround.

### ■ Surround parameters ③

#### DTS NEO:6 Mode:

• **Cinema:**

This mode is optimum for playing movies. Decoding is performed with emphasis on separation performance to achieve the same atmosphere with 2-channel sources as with 6.1-channel sources.

This mode is effective for playing sources recorded in conventional surround formats as well, because the in-phase component is assigned mainly to the center channel (C) and the reversed phase component to the surround (SL, SR and SB channels).

• **Music:**

This mode is suited mainly for playing music. The front channel (FL and FR) signals bypass the decoder and are played directly so there is no loss of sound quality, and the effect of the surround signals output from the center (C) and surround (SL, SR and SB) channels add a natural sense of expansion to the sound field.

#### CENTER IMAGE (0.0 to 1.0: default 0.3):

The center image parameter for adjusting the expansion of the center channel in the DTS NEO:6 MUSIC mode has been added.



### Memory and call-out functions (USER MODE function)

- The AVR-4306 is equipped with a function for storing the selected input source, the auto surround mode and input mode in the memory and selecting these settings when you want to use them.
- Three patterns of settings can be stored in the memory pressing the **USER MODE** buttons.

### ■ Storing the settings in the memory

- 1** The following are stored in the memory:
- ① Currently set input source
  - ② Currently set auto surround mode
  - ③ Currently set input mode

**2** Press and hold the **USER MODE** button for at least three seconds which you want to store the settings.

※ In this case, press the button and hold it in until the indicator of the selected **USER MODE** button lights.

### ■ Calling the settings out

Press the **USER MODE** button at which the settings you want to call out are stored.

- The indicator for the selected **USER MODE** button lights.

※ In this case, press the button and hold it in until the indicator of the selected **USER MODE** button lights.

### DENON original surround modes

The AVR-4306 is equipped with a high performance DSP (Digital Signal Processor) which uses digital signal processing to synthetically recreate the sound field. One of ten preset surround modes can be selected according to the program source and the parameters can be adjusted according to the conditions in the listening room to achieve a more realistic, powerful sound.

### Surround modes and their features

1	<b>7CH STEREO</b>	The front left channel signals are output to the surround and surround back left channels, the front right channel signals are output to the surround and surround back right channels, and the in-phase component of the left and right channels is output to the center channel. Use this mode to enjoy stereo sound.
2	<b>WIDE SCREEN</b>	Select this to achieve an atmosphere like that of a movie theater with a large screen. In this mode, all signal sources are played in the 7.1-channel mode, including Dolby Surround and Dolby Digital 5.1-channel sources. Effects simulating the multi surround speakers of movie theaters are added to the surround channels.
3	<b>SUPER STADIUM</b>	Select this when watching baseball or soccer programs to achieve a sound as if you were actually at the stadium. This mode provides the longest reverberation signals.
4	<b>ROCK ARENA</b>	Use this mode to achieve the feeling of a live concert in an arena with reflected sounds coming from all directions.
5	<b>JAZZ CLUB</b>	This mode creates the sound field of a live house with a low ceiling and hard walls. This mode gives jazz a very vivid realism.
6	<b>CLASSIC CONCERT</b>	Select this for the sound of a concert hall rich in reverberations.
7	<b>MONO MOVIE (NOTE)</b>	Select this when watching monaural movies for a greater sense of expansion.
8	<b>VIDEO GAME</b>	Use this to enjoy video game sources.
9	<b>MATRIX</b>	Select this to emphasize the sense of expansion for music sources recorded in stereo. Signals consisting of the component difference of the input signals (the component that provides the sense of expansion) processed for delay are output from the surround channel.
10	<b>VIRTUAL</b>	Select this mode to enjoy a virtual sound field, produced from the front 2-channel speakers or headphones.

※ Depending on the program source being played, the effect may not be very noticeable.  
In this case, try other surround modes, without worrying about their names, to create a sound field suited to your tastes.

**NOTE:** When playing sources recorded in monaural, the sound will be one-sided if signals are only input to one channel (left or right), so input signals to both channels. If you have a source component with only one audio output (monophonic camcorder, etc.) obtain a "Y" adapter cable to split the mono output to two outputs, and connect to the L and R inputs.

### ■ Personal memory plus

This set is equipped with a personal memorize function that automatically memorizes the surround modes and input modes selected for the different sources. When the input source is switched, the modes set for that source last time it was used are automatically recalled.

※ The surround parameters, tone control settings and playback level balance for the different output channels are memorized for each surround mode.

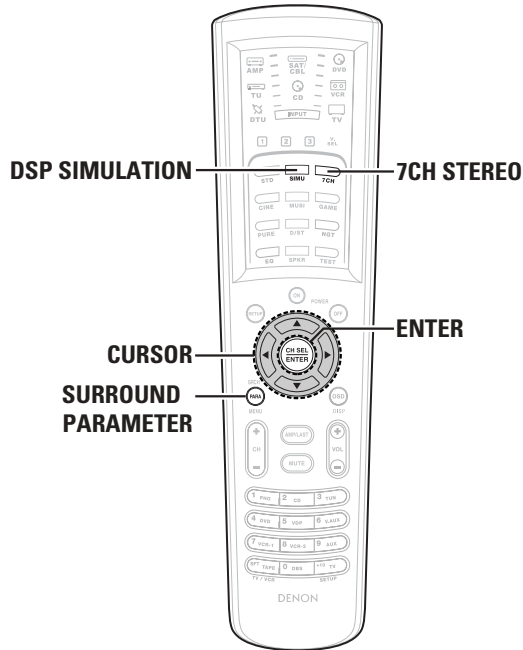
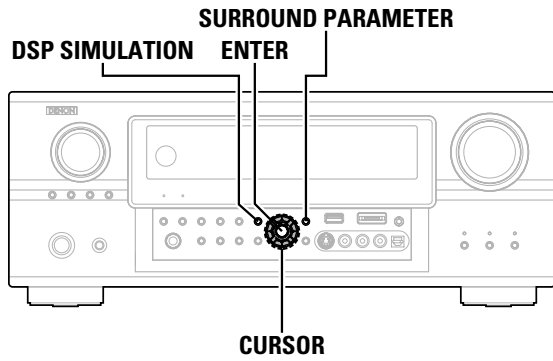

**DSP surround simulation**

**1 Press the DSP SIMULATION button to select the surround mode for the input channel.**

※ The surround mode switches in the following order each time the **DSP SIMULATION** button is pressed:

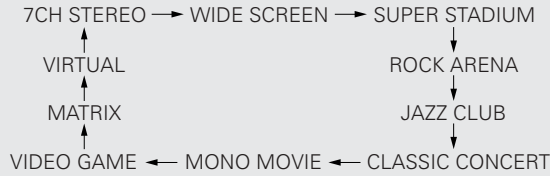

※ The 7CH STEREO mode can be selected directly by pressing the **7CH STEREO** button on the remote control unit.

**2 Press the SURROUND PARAMETER button.**

• The surround parameter menu is displayed.

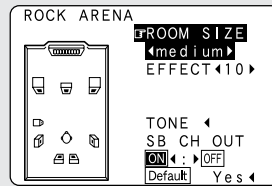

※ The screen for the selected surround mode appears.

**3 Press the CURSOR Δ or ∇ button to select the various surround parameters.**

**4 Press the CURSOR ◀ or ▶ button to adjust the parameter settings.**

**5 Press the ENTER or SURROUND PARAMETER button to complete the setting.**



• The “7CH STEREO” display changes as shown below according to the surround back speaker setting.

SURROUND BACK SPEAKER	DISPLAY
ON	7CH STEREO
OFF	5CH STEREO

• When “Default” is selected and the **CURSOR** ◀ button is pressed, “CINEMA EQ.” and “D.COMP.” are automatically turned off, “ROOM SIZE” is set to “medium”, “EFFECT LEVEL” to “10”, “DELAY TIME” to “30 ms” and “LFE” to “0 dB”.

• The “ROOM SIZE” expresses the expansion effect for the different surround modes in terms of the size of the sound field, not the actual size of the listening room.

■ Surround parameters ④

**EFFECT:**

This parameter turns the effect signals with multi surround mode speaker effects on and off in the WIDE SCREEN mode. When this parameter is turned off, the SBL and SBR channel signals are equivalent to the SL and SR channels, respectively.

**LEVEL:**

This parameter sets the strength of the effect signals in the WIDE SCREEN mode. It can be set in 15 steps, from “1” to “15”. Set this to a low level if the positioning or phase of the surround signals sounds unnatural.

**SB CH OUT**

- **ON:**  
Playback is conducted using the surround back speaker.
- **OFF:**  
Playback is conducted without using the surround back speaker.

**ROOM SIZE:**

This sets the size of the sound field. There are five settings: “small”, “med.s” (medium-small), “medium”, “med.l” (medium-large) and “large”. “small” recreates a small sound field, “large” a large sound field.

**EFFECT LEVEL:**

This sets the strength of the surround effect. The level can be set in 15 steps from 1 to 15. Lower the level if the sound seems distorted.

**DELAY TIME:**

The delay time can be set within the range of 0 to 300 ms only in the matrix mode.

**SW ATT:**

This is the parameter for reducing the level of the subwoofer channel when playing in the EXT. IN input mode. Depending on the player you are using, the subwoofer channel’s playback level may seem too high. If so, set “SW ATT” to “ON”. For DENON players, use with the default settings (“OFF”).

**Subwoofer ON/OFF:**

The subwoofer output can be controlled directly.

**Tone control setting**

- Use the tone control setting to adjust the bass and treble as desired.
- The tone control function will not work in the PURE DIRECT or DIRECT mode.

■ Adjusting the tone

- 1 Press the SURROUND PARAMETER button.**
  - The surround parameter menu is displayed.

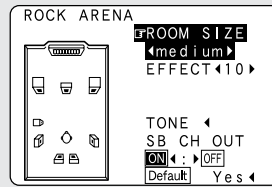

※ The screen selected surround mode appears.

- 2 Press the CURSOR Δ or ▽ button to select “TONE”.**

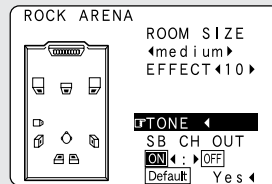

- 3 Press the CURSOR ◀ button.**
  - Switch to the “Tone Control” screen.

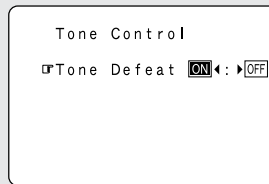

※ The screen selected surround mode appears.

- 4 Press the CURSOR ▷ button to select “Tone Defeat OFF”.**

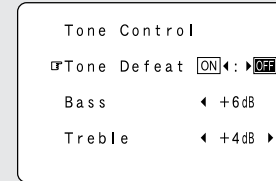

- 5 Press the CURSOR Δ or ▽ button to select “Bass” or “Treble”.**

- 6 Press the CURSOR ◀ or ▶ button to set the level.**

- ※ To increase the bass or treble:  
The bass or treble sound can be increased up to +6 dB in steps of 1 dB.
- ※ To decrease the bass or treble:  
The bass or treble sound can be decreased down to -6 dB in steps of 1 dB.

- 7 Press the ENTER button.**
  - The surround parameter menu screen reappears.

- 8 Press the ENTER or SURROUND PARAMETER button to complete the setting.**

■ Tone defeat mode

If you do not want the bass and treble to be adjusted, turn on the tone defeat mode. The signals do not pass through the bass and treble adjustment circuits, providing higher quality sound.

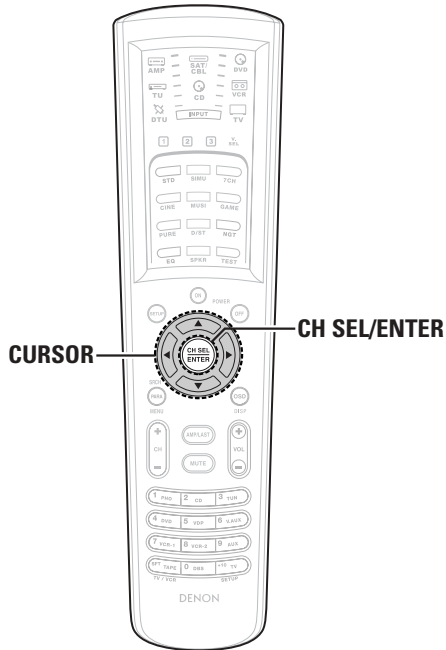
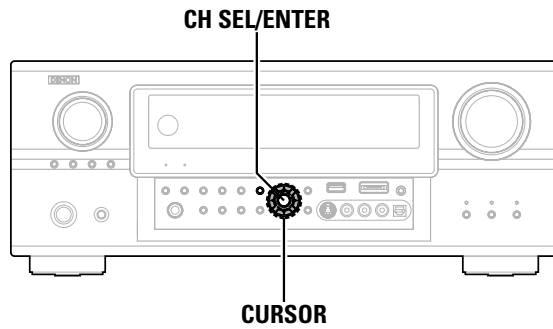

### Channel level

You can adjust the channel level either according to the playback sources or to suit your tastes, as described below.

- 1 Press the **ENTER** button.
  - The "Channel Vol." screen is displayed.

Channel Vol.			
FL	◀ 0.0dB	SR	0.0dB
C	0.0dB	SBR	0.0dB
FR	0.0dB	SBL	0.0dB
SW	0.0dB	SL	0.0dB
Fader			
FRONT ◀: ▶ REAR			

※ Channels which is not used are not displayed.

- 2 Press the **CURSOR**  $\Delta$ ,  $\nabla$  or **ENTER** button to select the speaker.

※ The channel switches as shown below each time the **ENTER** button is pressed.

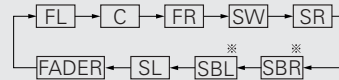

- 3 Press the **CURSOR**  $\triangleleft$  or  $\triangleright$  button to adjust the level.

- ※ The adjustment range for the different channels is +12 dB to -12 dB in step of 0.5 dB.
- ※ The sound from the subwoofer can be completely cut by lowering the SW (subwoofer) setting one additional from -12 dB (setting it to "OFF").



- When the surround back speaker setting is set to "1spkr" for "Speaker Configuration" (page 82), this is set to "SB".

### Fader function

This function makes it possible to lower the volume of the front channels (FL, C and FR) or the rear channels (SL, SR, SBL and SBR) together. Use it for example to adjust the balance of the sound from each position when multi-channel music sources are played.

- 1 Press the **ENTER** button.
  - The "Channel Vol." screen is displayed.

- 2 Press the **CURSOR**  $\Delta$ ,  $\nabla$  or **ENTER** button, then select "Fader".

Channel Vol.			
FL	0.0dB	SR	0.0dB
C	0.0dB	SBR	0.0dB
FR	0.0dB	SBL	0.0dB
SW	0.0dB	SL	0.0dB
Fader			
FRONT ◀: ▶ REAR			

※ The channel switches in the order shown below each time the **ENTER** button is pressed.

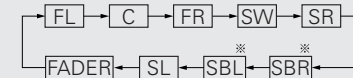

- 3 Press the **CURSOR**  $\triangleleft$  button to reduce the volume of the front channels, the **CURSOR**  $\triangleright$  button to reduce the volume of the rear channels.

**Example:** When "FRONT" is selected

Channel Vol.			
FL	-0.5dB	SR	0.0dB
C	-0.5dB	SBR	0.0dB
FR	-0.5dB	SBL	0.0dB
SW	0.0dB	SL	0.0dB
Fader			
FRONT ◀: ▶ REAR			

※ The fader function does not affect the subwoofer channel



- The channel whose channel level is adjusted lowest can be faded to -12 dB using the fader function.
- If the channel levels are adjusted separately after adjusting the fader, the fader adjustment values are cleared, so adjust the fader again.

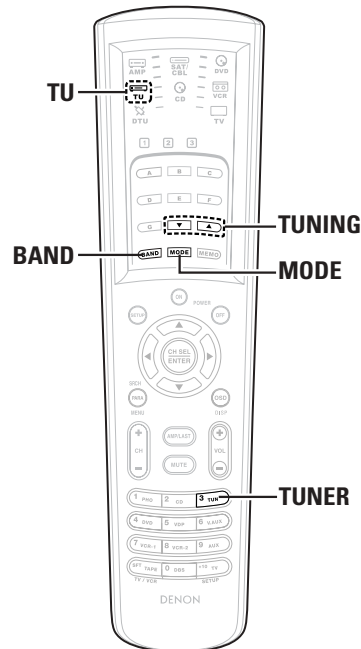
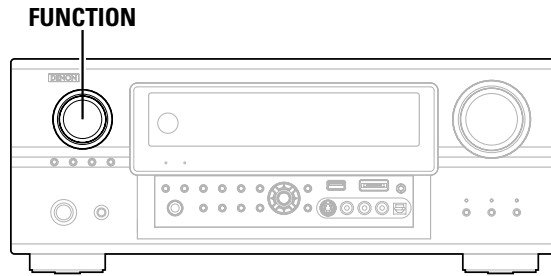

## Listening to the radio

Check that the remote control unit is set to AMP or TUNER.

### Auto tuning

**1** Set the input source to “TUNER”.

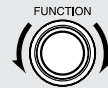

(Main unit)



(Remote control unit in the AMP mode)

**2** Press the **TU (TUNER)** button to select the TUNER mode.



(Remote control unit)

**3** Watching the display, press the **BAND** button to select the desired band (AM, FM or XM).

※ When listening to the XM Satellite Radio (page 42).

**4** Press the **MODE** button to set the auto tuning mode.

- “AUTO” indicator appears on the display.

**5** Press the **TUNING** button.

- Automatic searching begins, then stops when a station is tuned in.



- If tuning does not stop at the desired station, use to the “Manual tuning” operation.

### Manual tuning

**1** Set the input source to “TUNER”.

**2** Press the **TU (TUNER)** button to select the TUNER mode.

**3** Watching the display, press the **BAND** button to select the desired band (AM, FM or XM).

※ When listening to the XM Satellite Radio (page 42).

**4** Press the **MODE** button to set the manual tuning mode.

※ Check that the display’s “AUTO” indicator turns off.

**5** Press the **TUNING** button to tune in the desired station.

※ The frequency changes continuously when the button is held in.



- When in the auto tuning mode on the FM band, the “STEREO” indicator lights on the display when a stereo broadcast is tuned in. At open frequencies, the noise is muted and the “TUNED” and “STEREO” indicators turn off.
- When the manual tuning mode is set, FM stereo broadcasts are received in monaural and the “STEREO” indicator turns off.

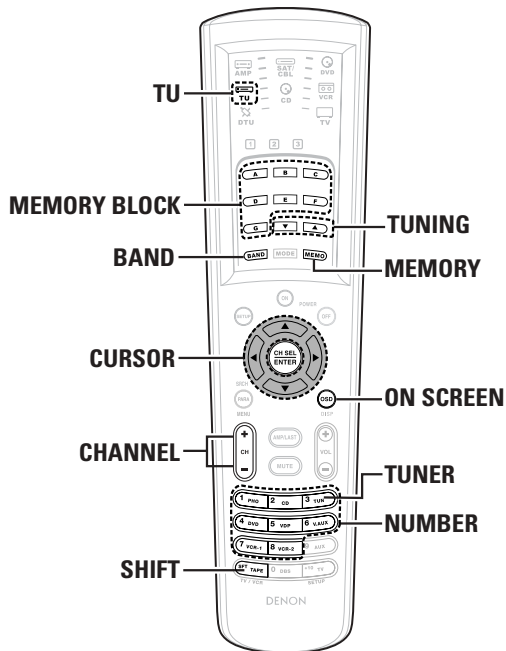
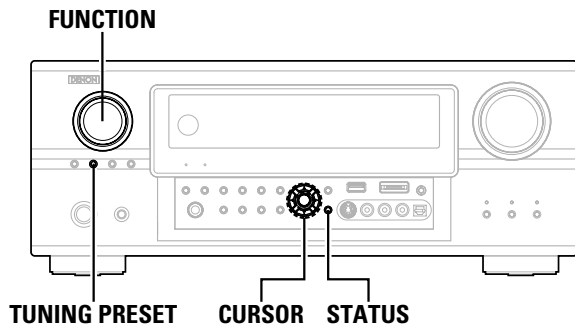

**Preset memory**

- 1** Use the “Auto tuning” or “Manual tuning” operation to tune in the station to be preset in the memory.
- 2** Press the **TU** (TUNER) button to select the TUNER mode.
- 3** Press the **MEMORY** button.
- 4** Press the **MEMORY BLOCK (A to G)** button.  
 ※ The memory block can also be selected by pressing the **SHIFT** button.
- 5** Press the **CHANNEL** button or **NUMBER (1 to 8)** button to select the desired preset channel.
- 6** Press the **MEMORY** button again.
  - Store the station in the preset memory.



- To preset other channels, repeat steps 3 to 6.  
 A total of 56 broadcast stations can be preset — 8 stations (channels 1 to 8) in each of blocks A to G.

**Checking the preset stations**

The preset (broadcast) stations can be checked on the on screen display.

Press the **ON SCREEN** button (in the AMP mode) repeatedly until the “Tuner Preset Stations” screen appears on the OSD.

Tuner Preset Stations	
A1FM	87.50MHz
A2FM	89.10MHz
A3FM	98.10MHz
A4FM	107.90MHz
A5FM	90.10MHz
A6FM	90.10MHz
A7FM	90.10MHz
A8FM	90.10MHz

OSD-8

**Recalling preset stations**

■ **Recalling preset stations from the remote control unit**

- 1** Select the memory block (A to G).
- 2** Watching the display, press the **CHANNEL** button or **NUMBER (1 to 8)** button to select the desired preset channel.

■ **Recalling preset stations from the main unit’s panel**

- 1** Press the **TUNING PRESET** button.
- 2** Turn the **FUNCTION** knob and select the desired preset channel.

**XM Satellite Radio**

AVR-4306 is the XM Ready® receiver. You can receive XM Satellite Radio® by connecting to the XM Connect-and-Play™ (sold separately) and subscribing the XM service.

**■ Introducing XM Satellite Radio**

There's a world of audio listening pleasure beyond AM and FM. XM Satellite Radio. Select from over 150 channels of music, news, sports, comedy, talk, and entertainment. Coast-to-coast coverage. Digital quality sound. With all music channels 100% commercial free.

Questions?: Visit [www.xmradio.com](http://www.xmradio.com).

**■ How to Subscribe**

Listeners can subscribe by visiting XM on the Web at [www.xmradio.com](http://www.xmradio.com) or by calling XM's Listener Care at (800) 967-2346.

Customers should have their Radio ID and credit card ready. The Radio ID can be found by selecting channel 0 on the radio.

**■ A Warning Against Reverse Engineering**

It is prohibited to copy, decompile, disassemble, reverse engineer, or manipulate any technology incorporated in receivers compatible with the XM Satellite Radio system.

Furthermore, the AMBE® voice compression software included in this product is protected by intellectual property rights including patent rights, copyrights, and trade secrets of Digital Voice Systems, Inc. The user of this or any other software contained in an XM Radio is explicitly prohibited from attempting to copy, decompile, reverse engineer, or disassemble the object code, or in any other way convert the object code into human-readable form. The software is licensed solely for use within this product.

Hardware and required basic monthly subscription sold separately. Premium Channel available at additional monthly cost.

Installation costs and other fees and taxes, including a one-time activation fee may apply. Subscription fee is consumer only.

All fees and programming subject to change. Subscriptions subject to Customer Agreement available at [xmradio.com](http://xmradio.com).

Only available in the 48 contiguous United States. ©2005 XM Satellite Radio Inc. All rights reserved. All other trademarks are the property of their respective owners.

**Checking the XM signal strength and Radio ID**

**1** Set the input source to "TUNER".

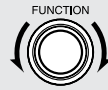

(Main unit)



(Remote control unit in the AMP mode)

**2** Press the **TU (TUNER)** button to select the **TUNER** mode.

**3** Watching the display, press the **BAND** button to select the **XM** mode.

**4** Press the **STATUS** button on the main unit until "SIGNAL" is displayed.

- The display changes as shown below according to the receiving condition.

Display	Condition
GOOD	Signal strength is good
MARGINAL	Signal strength is marginal
WEAK	Signal strength is poor
NO	Loss of the signal

**5** Adjust the antenna location until "SIGNAL:GOOD" is displayed.

**6** Press the **STATUS** button until the XM channel (ex.XM001) is displayed.

**7** Press the **TUNING** ▼ button to select channel 0 (XM000).

- The Radio ID is displayed.



Radio ID

**Channel selection**

**1** Set the input source to "TUNER".

**2** Press the **TU (TUNER)** button to select the **TUNER** mode.

**3** Watching the display, press the **BAND** button to select the **XM** mode.

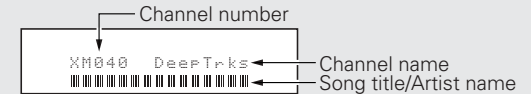

**4** Press the **TUNING** ▲ or ▼ button to reach the desired channel.

- ※ The channel changes continuously when you press and hold the **TUNING** button.
- ※ When the artist name and song title are received, they are displayed.

**Category search**

**1** Press the **CURSOR** ◀ or ▶ button in the **XM** mode.

- The current category name is displayed.

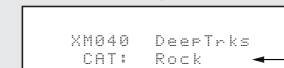
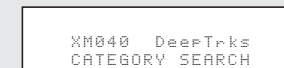

Channel Category

**2** Press the **CURSOR** ◀ or ▶ button to select the category, and press the **CURSOR** ▲ or ▼ button to select the channel within the selected category.

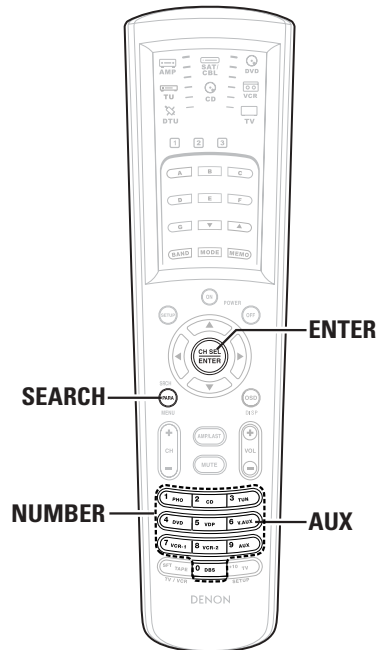
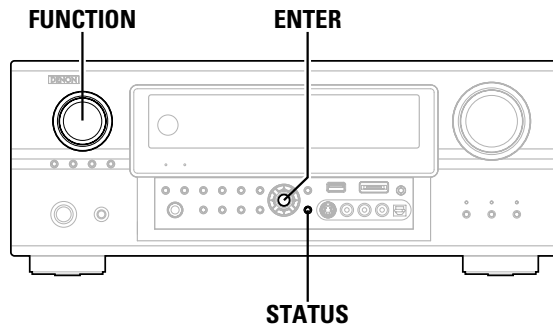

**Direct access of channels**

**1** Press the **SEARCH** button in the **XM mode**.

**2** Press the **NUMBER** buttons to enter the desired channel.

※ For example, if you want to access channel 123 (ex.XM123) press the Number buttons as shown below.

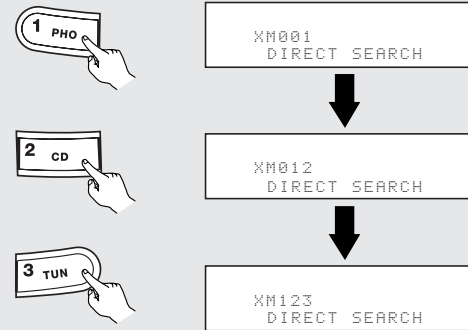

(Remote control unit)

**3** Once all number have been input, press the **ENTER** button to change the channel.

※ If the next **NUMBER** button is not pressed within several seconds, the channel automatically switches to the channel number that was input.



- "LOADING" is displayed while receiving the channel or information.



- "UPDATING" is displayed while updating encryption code.



- When the selected channel is not available, "XM- -" is displayed.



- Information on the artist name, song title, category and signal level can be checked using the **STATUS** button on the main unit.
- The XM Satellite Radio channels can be preset in the same way as AM/FM band.

Please refer to "Preset memory" and "Recalling preset stations" (👉 page 41).



**Playing the iPod®**

Music stored on an iPod can be played when the iPod is connected to the AVR-4306's iPod connector. The iPod can be controlled using the buttons on the main unit and the remote control unit.



iPod is a trademark of Apple Computer, Inc., registered in the U.S. and other countries.

※ With the iPod, non-copyrighted contents and contents that may be legally reproduced or played may be reproduced and played by individuals for their personal use. Violating copyrights is prohibited by law.

**Connecting the iPod**

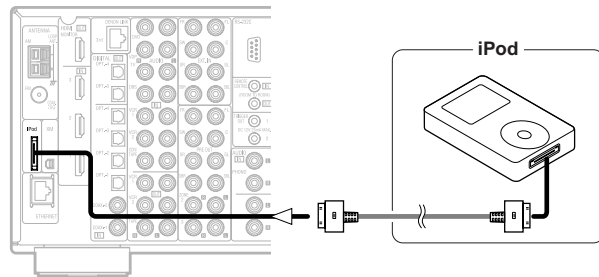
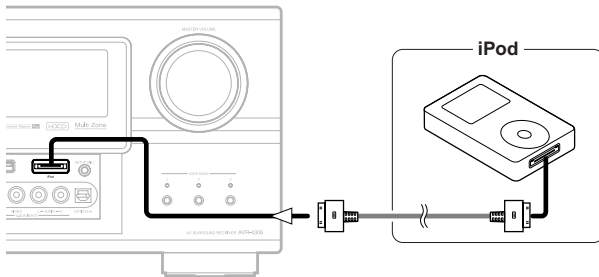

**1** Connect the AVR-4306 and iPod using the iPod cable.

**2** Select the input source to “AUX/iPod”.

- The iPod music menu screen is displayed.

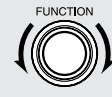

(Main unit)



(Remote control unit in the AMP mode)

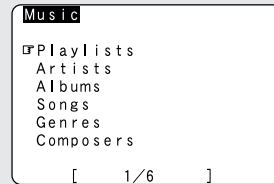

Display

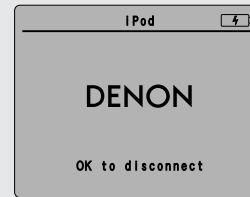

(iPod screen)

※ If the screens above are not displayed, the iPod may not be properly connected. Try connecting again.

**NOTE:**

- The AVR-4306 is equipped with two iPod connectors, one each on the front and rear panels. It is not possible to use the set with iPods connected to both the connectors at the same time. Only connect one iPod at a time.
- DENON will accept no responsibility whatsoever for loss or damage of data on an iPod occurring when the iPod is used connected to the AVR-4306.
- The maximum battery charge output from the iPod connector is 8 W.



- Connect the iPod cable (sold separately) directly to the iPod. (To connect via an iPod Dock, see “Setting the iPod Assign” (page 68)).
- Some of the functions may not operate, depending on the type of iPod and the software version.

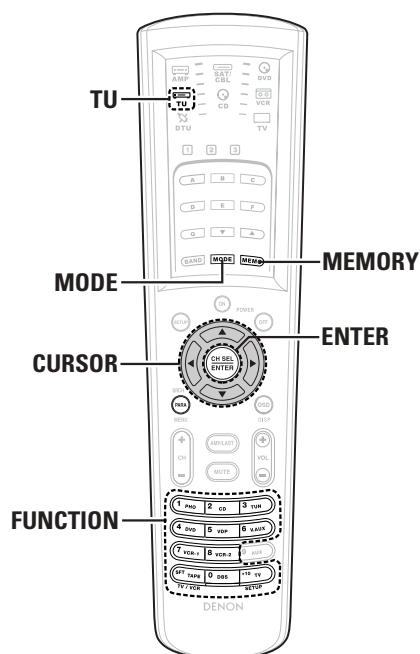
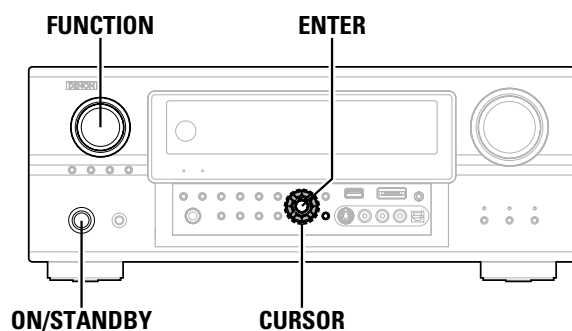

### Listening to music

**1** Press the **CURSOR**  $\Delta$  or  $\nabla$  button to select the music file you want to play, then press the **ENTER** or **CURSOR**  $\triangleright$  button.

- Press the **CURSOR**  $\triangleleft$  button to return to the music menu screen.

**2** Press the **ENTER** or **CURSOR**  $\triangleright$  button.

- Playback starts.

#### Pause:

Press the **ENTER** button during playback.  
Press again to resume.

#### Manual search:

Press and hold in the **CURSOR**  $\Delta$  or  $\nabla$  button during playback.

- $\Delta$  : Fast reverse
- $\nabla$  : Fast forward

#### Track search:

Press the **CURSOR**  $\Delta$  or  $\nabla$  button during playback.

- $\Delta$  : Move to beginning of previous track
- $\nabla$  : Move to beginning of next track

#### Stop:

Press the **ENTER** button for at least 2 seconds during playback.

#### Repeat play:

Press the **TU** (TUNER) button, then press the **MODE** button.  
The mode switches as follows each time the **MODE** button is pressed.

- **RPT One**: Single track repeat
- **RPT ALL**: All track repeat

#### Shuffle play:

Press the **TU** (TUNER) button, then press the **MEMORY** button.  
The mode switches as follows each time the **MEMORY** button is pressed.

- **SFL Songs** : Single track shuffle
- **SFL Albums**: Album shuffle

\* The mode switches between the Browse mode and the Remote mode if the **MODE** button is pressed for at least 2 seconds after pressing the **TU** (TUNER) button.  
In the Remote mode, only the **CURSOR** buttons and the **ENTER** button can be used.



- When the **STATUS** button is pressed during playback, the front panel display switches between the title name, artist name and album name.
- The iPod's backlight turns on when the **CURSOR**  $\triangleleft$  button is pressed for more than two seconds while in the Remote mode. When the backlight is on, it can be turned off by pressing the **CURSOR**  $\triangleleft$  button for more than two seconds.
- Depending on the iPod's software version, it may not be possible to operate the iPod from the AVR-4306. Use the latest version of the software. Information on the latest version of the software can be obtained on the Apple Computer website.
- If you do not want the OSD to be displayed while playing the iPod, set "Function/Mode Status" at "Setting the On Screen Display" to "OFF" (page 73).
- With the AVR-4306 it is possible to display folder names and file names on the screen like titles. The AVR-4306 can display up to 64 characters, consisting of numbers, capital letters and small letters. A "?" mark is displayed in place of non-compatible characters.

### Viewing still pictures (only for iPods equipped with the slideshow function)

Use this procedure to view photo data stored on the iPod on a TV monitor.

**1** Press the **TU** (TUNER) button, then press the **MODE** button for at least 2 seconds to switch from the Browse mode to the Remote mode.

- "Remote iPod" is displayed on the AVR-4306's display.

**2** Watching the iPod's screen, press the **CURSOR**  $\Delta$  or  $\nabla$  button to select "Photos", then press the **ENTER** or **CURSOR**  $\triangleright$  button.

- The iPod's photo data is displayed on the TV monitor.

### Disconnecting the iPod

We recommend either pressing the **ON/STANDBY** button to set the AVR-4306's power to the standby mode, or turning the **FUNCTION** knob on the AVR-4306 or pressing the **FUNCTION** button on the remote control unit to set the input source to something other than "AUX/iPod".

## Using the Network Audio Function

The AVR-4306 can be connected to a network by cable to listen to Internet radio or music files stored on computers.

### Internet radio function

Internet radio refers to radio programs broadcast over the Internet.

There are many stations throughout the world broadcasting Internet radio programs. These stations are of all sizes and types, some run by individuals, others by ground wave broadcast stations.

While ground wave radio stations can only be listened to within the range in which the waves reach, Internet radio can be listened to anywhere in the world.

The AVR-4306 is equipped with the following Internet radio functions:

- Stations can be selected by genre and region.
- Up to 56 Internet radio stations can be preset.
- MP3 format Internet radio programs can be listened to.
- Your favorite radio stations can be registered by accessing the exclusive DENON Internet radio URL using a computer's browser. (The AV amplifier automatically downloads the registration settings (approximately once every other day).) (This is managed separately for each unit, so a MAC address or e-mail address must be registered.) (🔗 page 81)
- ※ Exclusive URL : <http://www.RadioDenon.com>

### vTuner

The AVR-4306's Internet radio station list uses "vTuner", a radio station database service. This database service is edited and prepared for the AVR-4306.

### Music server function

The AVR-4306 is equipped with a network audio playback function allowing music files stored on a computer to be played via a LAN (Local Area Network).

The AVR-4306's network audio playback function connects to servers using the following technologies:

- Windows Media Connect
- The Designed to DLNA Guideline
- Windows Media DRM 10 (for network devices)

### System requirements

The preparations described below must be made in order to use the Internet radio and music server functions.

### ■ Broadband Internet connection

A broadband connection to the Internet is necessary in order to use the AVR-4306's Internet radio function.

#### NOTE:

- **You must have a contract with an Internet Service Provider (ISP) in order to connect to the Internet.** For instructions on connecting to the Internet, contact your ISP or a computer store.
- If you already have a broadband Internet connection there is no need to take out another contract.

### ■ Modem

A modem is a device for exchanging signals over the Internet using a broadband connection. Some are integrated into routers. For instructions on connecting to the Internet, contact your ISP or a computer store.

### ■ Router

A router is a device for connecting multiple pieces of equipment (computers, the AVR-4306, etc.) to the Internet simultaneously. When using the AVR-4306, we recommend a router equipped with the following functions:

- Built-in DHCP (Dynamic Host Configuration Protocol) server.  
Function for automatically assigning the device's IP address on the LAN.
- Built-in 100BASE-TX switch  
When connecting multiple devices, it is recommended to have a built-in switching hub with a speed of 100 Mbps or greater.

#### NOTE:

- The type of router that can be used differs for different ISPs. For details, contact your ISP or a computer store.

### ■ Ethernet cable (CAT-5)

The AVR-4306 does not come with an Ethernet cable. Purchase one of the required length.

### ■ Personal Computer

Install "Windows Media Connect" on your computer. The required system for forming a music server is as described below.

- 1) OS (Operating System):  
Windows® XP Service pack2
- 2) Processor:  
Intel Pentium®II or AMD processor, etc..  
We recommend 1 GHz or greater.
- 3) RAM:  
Min. 128 MB, we recommend 256 MB or greater.
- 4) Software:  
.NET Framework 1.1
- 5) Internet browser:  
Microsoft Internet Explorer 5.01 or later

- LAN port required
- 300 MB or greater free hard disc space required

※ Extra free space is necessary to store music files.

The following table gives an approximate estimate of the required free space.

Format	Bit rate	Per one minute	Per one hour
MP3 / WMA	128 kbps	1 MB	60 MB
	192 kbps	1.5 MB	90 MB
	256 kbps	2 MB	120 MB
	392 kbps	3 MB	180 MB
WAV (LPCM)	1400 kbps	10 MB	600 MB

### ■ Others

- When the contract with your provider is of the type by which the network settings are made manually, you must make the "Network Setup" (🔗 page 80, 81).
- The AVR-4306 is not compatible with PPPoE. If your contract is of the PPPoE setting type, you need a PPPoE-compatible router.
- For some ISPs (Internet Service Providers), you may have to make proxy server settings in order to use the Internet radio function. If proxy server settings for connecting to the Internet have been made on the computer, make the same settings on the AVR-4306.
- The AVR-4306 is designed to make the network settings automatically using the DHCP and Auto IP functions.

## Basic Operation

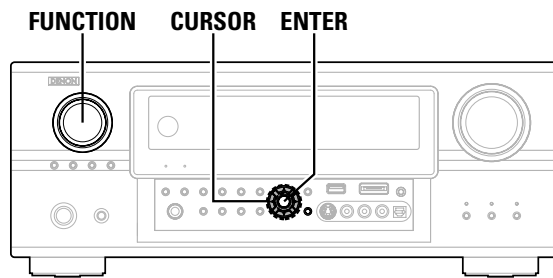

## DTU (Digital tuner) system buttons

The digital tuner system buttons shown on the diagram below are used for Network Audio operations.

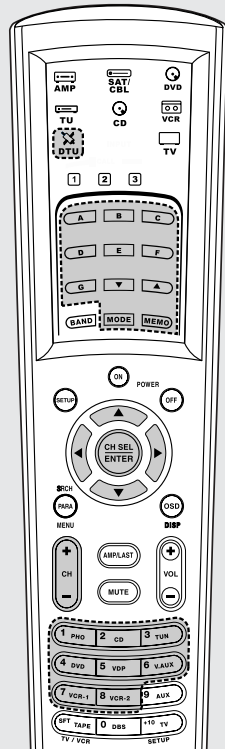

- A ~ G** : Preset memory blocks
- ▲, ▼** : Character search
- MODE** : Configuration mode selection
- MEMO** : Preset and favorite registration
- ▲, ▼, ◀, ▶** : Cursor up, down, left and right
- ENTER** : Enter settings
- CH +, -** : Preset channel selection
- 1 ~ 8** : Preset numbers

## Connections

Connect one side of the Ethernet cable (CAT-5) to the ETHERNET terminal on the AVR-4306's rear panel, the other side to the router.

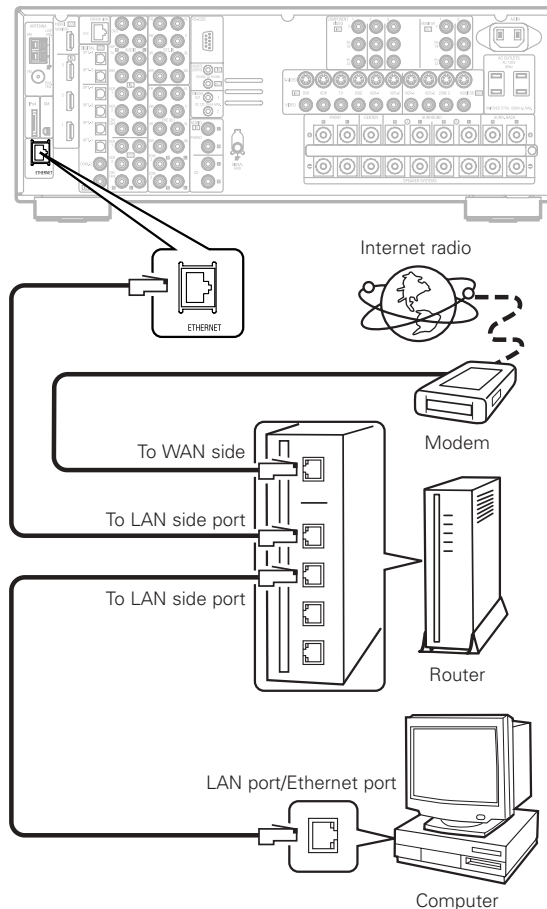

## Network settings

When using a broadband router (DHCP function), the network settings are made automatically, so there is no need to make the settings from the setup menu.

If the broadband router's DHCP function is turned off, make the "Network Setup" (page 80, 81).

## Basic Operation

### Listening to Internet radio

The required system connections and settings must be made in order to listen to Internet radio. "Update?" appears on the display when connecting to an Internet radio station for the first time.

- Select the input source to "AUX/Net".**
  - The "Network Audio" menu screen appears.

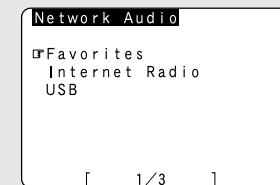
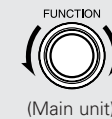

- Press the CURSOR ▲ or ▼ button to select "Internet Radio", then press the ENTER or CURSOR ▷ button.**
  - The initial screen when not connected to the Internet is displayed.

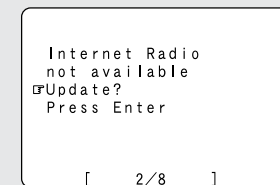

- Connecting to an Internet radio station for the first time:**

**Press the ENTER or CURSOR ▷ button.**

- The update screen appears.

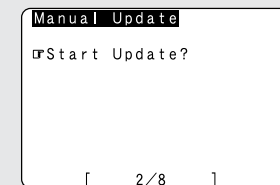

#### 4 Press the **ENTER** or **CURSOR** $\triangleright$ button once again.

- The latest list of radio stations is downloaded from the vTuner site. (Several minutes are required for this download.)

#### 5 Press the **CURSOR** $\triangle$ or $\nabla$ button to select the desired setting item, then press the **ENTER** or **CURSOR** $\triangleright$ button.

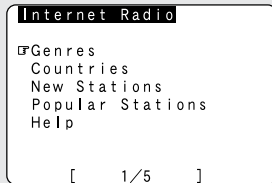

- ※ Finally, the list of Internet radio stations is displayed and those that can be played are indicated by the “\*” mark in front of them.

#### 6 Press the **CURSOR** $\triangle$ or $\nabla$ button to select the desired radio station, then press the **ENTER** or **CURSOR** $\triangleright$ button.

- Connection starts, and the station starts playing once the buffer reaches “100%”.
- ※ During playback, press the **ENTER** button once to pause playback, then press **ENTER** button again to resume playback.
- ※ If the **ENTER** button is pressed and held in for more than two seconds when in the play or pause mode, playback stops and the previous menu window reappears.



- There are many Internet radio stations on the Internet. The programs they broadcast and their bit rates vary widely. Generally, the higher the bit rate, the higher the sound quality, but streamed music or sound may be broken if the communication lines or servers are busy. Inversely, programs with low bit rates have lower sound quality but tend to be more stable.
- “Server Full” or “Connection Down” is displayed if the station is congested or if it is not broadcasting.
- If you do not want the OSD to be displayed while playing Network Audio (internet radio, music server or USB), set “Function/Mode Status” at “Setting the On Screen Display” to “OFF” (🔧 page 73).

### Presetting (registering) Internet radio stations

There are two ways to register stations: by presetting them or by storing them in your favorites.  
Stations that are preset can be tuned in directly from the remote control unit.

#### 1 Press the **MEMORY** button while playing the Internet radio station you want to register.

- The registration menu screen appears.



#### 2 Press the **CURSOR** $\triangle$ or $\nabla$ button to select “Preset”, then press the **ENTER** or **CURSOR** $\triangleright$ button.

- The preset registration screen appears.

#### 3 Press a **MEMORY BLOCK** (A ~ G) button, then press a **NUMBER** (1 ~ 8) button to register the station at the desired preset channel.

- This completes registration.
- ※ If no button is operated for approximately ten seconds, the regular display reappears.
- ※ Registered presettings can be checked on the on screen display.  
The presettings can only be displayed with the on screen display when the “AUX/Net” function is selected.

#### NOTE:

- Registered presettings are deleted when they are overwritten.

### ■ Listening to preset Internet radio stations

When the “AUX/Net” function is selected, press a **MEMORY BLOCK** (A ~ G) button, then press a **NUMBER** (1 ~ 8) button.

- The connection is made automatically and playback starts.

### Registering Internet radio stations in your favorites

Your favorites are listed at the top of the menu screen, so registered stations can be tuned in easily.

#### 1 Press the **MEMORY** button while playing the Internet radio station you want to register.

- The registration menu screen appears.



#### 2 Press the **CURSOR** $\triangle$ or $\nabla$ button to select “Favorites”, then press the **ENTER** or **CURSOR** $\triangleright$ button.

- The favorites registration screen appears.

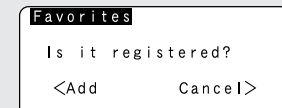

#### 3 Press the **CURSOR** $\triangleleft$ button to register the station.

- ※ To cancel without registering, press the **CURSOR**  $\triangleright$  button.

### ■ Listening to Internet radio stations registered in your favorites

#### 1 When the “AUX/Net” function is selected, press the **CURSOR** $\triangle$ or $\nabla$ button to select “Favorites”, then press the **ENTER** or **CURSOR** $\triangleright$ button.

- The Internet radio stations registered in your favorites are displayed.

#### 2 Press the **CURSOR** $\triangle$ or $\nabla$ button to select the desired radio station, then press the **ENTER** or **CURSOR** $\triangleright$ button.

- Playback starts.

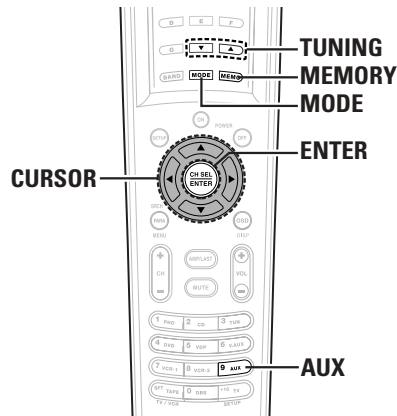
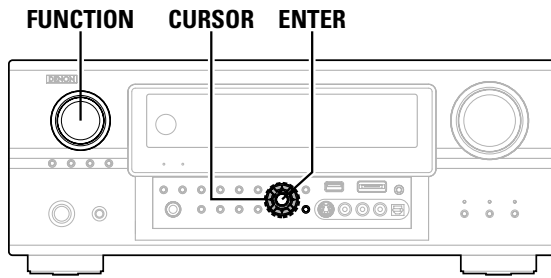

**Deleting radio stations from your favorites**

**1** At the screen on which the Internet radio stations registered in your favorites are displayed, press the **CURSOR**  $\Delta$  or  $\nabla$  button to choose the radio station you want to delete, then press the **MEMORY** button.

- The delete screen appears.

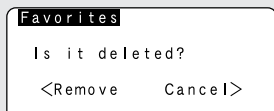

**2** Press the **CURSOR**  $\triangleleft$  button to delete the station.

- ※ To cancel without deleting, press the **CURSOR**  $\triangleright$  button.

**Character search function (searching by first letter)**

The character search function (searching by first letter) can be used to select the desired item from the menu screen displaying the list of Internet radio stations or music files stored on the computer.

**1** While the menu screen is displayed, press the **TUNING**  $\Delta$  or  $\nabla$  button.

- The character search screen appears.

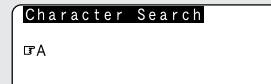

**2** Press the **TUNING**  $\Delta$  or  $\nabla$  button to select the first letter of the item you want to search for.

- After several seconds, the menu screen is displayed with the cursor set to the item starting with the letter selected in step 2.

- ※ If there is more than one item starting with the letter selected in step 2, the items are displayed in alphabetical order.

**Updating the list of radio stations**

**1** Press the **MODE** button to select the configuration mode, then press the **ENTER** or **CURSOR**  $\triangleright$  button.

- The settings screen appears.

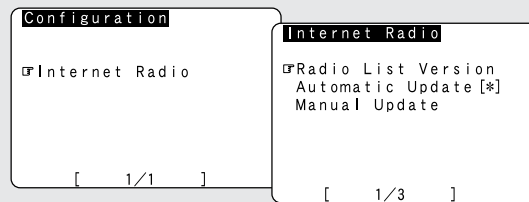

**2** Press the **CURSOR**  $\Delta$  or  $\nabla$  button to select “Automatic Update” or “Manual Update”, then press the **ENTER** or **CURSOR**  $\triangleright$  button.

- The update screen appears.

- ※ Select “Radio List Version” to display the current version.

**3** When “Automatic Update” is selected:  
**1** Press the **ENTER** or **CURSOR**  $\triangleright$  button to select -1 “Yes”.

- The list of radio stations is updated approximately once every other day.

**3** When “Manual Update” is selected:  
**1** Press the **ENTER** or **CURSOR**  $\triangleright$  button.

- 2 • The list of radio stations is updated this one time.



- When “Yes” is set for “Automatic Update”, set “Power Saving” in the “Network Setup” to “OFF” (page 81). When used with “Power Saving” set to “ON”, we recommend performing the “Manual Update” procedure periodically (about once a week).

**Playing music files stored on the computer (music server)**

The necessary system connections and settings must be made in order to play music files.

This procedure is used to play music files (in WMA, MP3 and WAV format) stored on computers (music servers) connected to the AVR-4306 via the network.

The computer’s server program must be launched before using this function. For details, refer to the server program’s operating instructions.

**1** Select the input source to “AUX/Net”.

- The “Network Audio” menu screen appears.

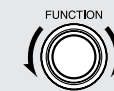

(Main unit)



(Remote control unit in the AMP mode)



- ※ The host names of the computer(s) (music server(s)) on the network are displayed.

**2** Press the **CURSOR**  $\Delta$  or  $\nabla$  button to select the host name of the computer (music server) on which the music file you want to play is located, then press the **ENTER** or **CURSOR**  $\triangleright$  button.

**3** Press the **CURSOR**  $\Delta$  or  $\nabla$  button to select the search item or the desired folder, then press the **ENTER** or **CURSOR**  $\triangleright$  button.

※ Playable music files are indicated by the “\*” mark in front of them.

**4** Press the **CURSOR**  $\Delta$  or  $\nabla$  button to select the music file, then press the **ENTER** or **CURSOR**  $\triangleright$  button.

• Connection starts, and playback starts once the buffer reaches “100%”.

※ Press the **CURSOR**  $\nabla$  button to select the next file, the **CURSOR**  $\Delta$  button to select the previous file.

※ During playback, press the **ENTER** button once to pause playback, then press the **ENTER** button again to resume playback.

※ If the **ENTER** button is pressed and held in for more than 2 seconds when in the play or pause mode, playback stops and the previous menu screen reappears.

**■ Playing music files that have been preset or registered in your favorites**

The same operations as for Internet radio stations can be used to preset music files or register them in your favorites and play them.

**NOTE:**

- Registered presettings are deleted when they are overwritten.
- When the operations describe below are performed, the music server database is updated and it may no longer be possible to play the music files that have been preset or registered in your favorites:
  - When the music server is stopped and restarted.
  - When music files are deleted from or added to the music server.
- When using an ESCIENT server, place “ESCIENT” before the server name.

**Operating the AVR-4306 using a browser**

Internet Explorer can be used on the computer connected to the AVR-4306 over the network to operate the AVR-4306.

Check the AVR-4306’s IP address (page 80) beforehand and input this IP address in Internet Explorer to display the AVR-4306’s control panel.

Operate in the same way as with normal Internet browsing to control the AVR-4306.

**Playing the USB (mass storage) device**

Music files (WMA, MP3 and WAV) stored on a USB device can be played by connecting the USB device to the AVR-4306.

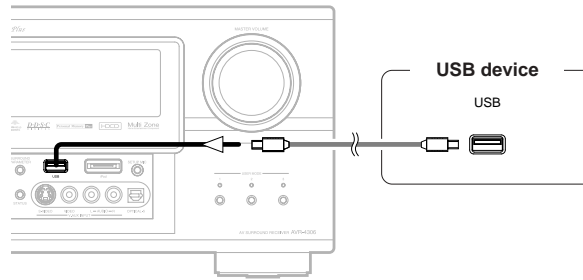

**An operation method is the same as “Playing music files stored on the computer (music server)”.**

※ **REPEAT MODE:**

When the **MODE** button is pressed while playing a USB device, the repeat mode switches as shown below.



※ **RANDOM MODE:**

When the **MEMORY** button is pressed, the random mode switches as shown below.

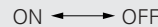

※ When the **SEARCH** button is pressed while a USB device or folder is selected, playback of all the files on the USB device or in the folder begins.



- AVR-4306 corresponds to playing the USB device of mass storage class.
- Compatible with USB devices in FAT16 or FAT32 format.
- If the USB device is divided into multiple partitions, only the files on the drive with the lowest drive number on that partition are selected.
- The AVR-4306 is compatible with the “MPEG-1 Audio Layer 3” standards (sampling frequency of 32, 44.1 or 48 kHz). It is not compatible with such other standards as “MPEG-2 Audio Layer 3”, “MPEG-2.5 Audio Layer 3”, MP1, MP2, etc. WMA (Windows Media) files recorded with a sampling frequency (fs) of 32, 44.1, and 48 kHz are supported.
- Applicable bit rates: 32 to 320 kbps for MP3 files, 48 to 192 kbps for WMA (Windows Media) files.
- With the AVR-4306 it is possible to display folder names and file names on the screen like titles. The AVR-4306 can display up to 95 characters, consisting of numbers, capital letters and small letters. A “?” mark is displayed in place of non-compatible characters.
- With the AVR-4306, only music files that are not copyright protected\* can be played.
  - \*: Contents downloaded from pay distribution sites on the Internet are copyright protected. Also, when CDs or other media are ripped on a computer and encoded in WMA format, they may be copyright protected, depending on the computer’s settings.
- When the **STATUS** button is pressed during playback, the front panel display switches between the title name, artist name and album name.
- The MP3 ID3-Tag (Ver. 2) function is compatible with title and artist names.
- The WMA meta tag function is compatible with title, artist and album names.
- The audio signals are not output from the digital output terminal.

**NOTE:**

- DENON will accept no responsibility whatsoever for loss or damage of data occurring on a USB device when the USB device is used connected to the AVR-4306.
- USB devices does not operate when connected via a USB hub.
- Please note that operation of and power supply to all USB devices is not guaranteed.
- It is not possible to connect the AVR-4306 to a computer using a USB cable.
- The AVR-4306 is not compatible with iPod shuffle.

# Advanced Operation



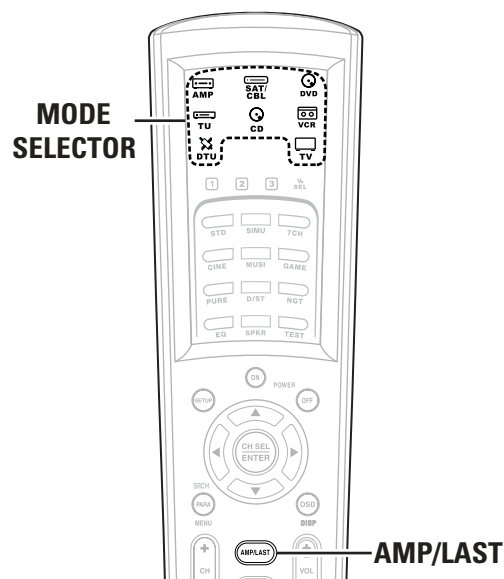





## Remote control unit



## Operating DENON audio components

**1** Press the **MODE SELECTOR** buttons to select the component you want to operate.

- The icon for the selected mode flashes.

-  : AMP, ZONE2, ZONE3 or SYSTEM CALL
-  : TUNER
-  : DIGITAL TUNER
-  : SATELLITE or CABLE
-  : CD or CDR
-  : DVD or DVDR
-  : VCR or TAPE
-  : TV

※ This function switches as shown below each time one of the **AMP** button is pressed.

**Example:**  
Select "AMP" mode.

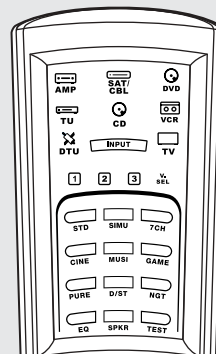

Select "ZONE2" mode.

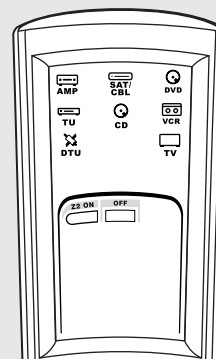

Select "ZONE3" mode.

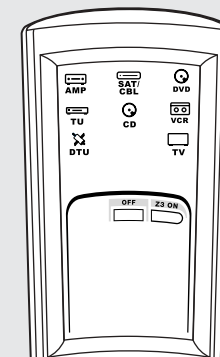

Select "SYSTEM CALL" mode.

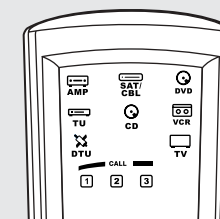

## 2 Operate the audio component.

- ※ For details, refer to the component's operating instructions.
- ※ It may not be possible to operate some models.



- When a remote control code is sent, the icon for the mode of the device to which that code belongs flashes.
- When the **AMP/LAST** button is pressed, it is possible to switch between the AMP mode (AMP, ZONE2, ZONE3 or SYSTEM CALL) and the last selected non-amplifier universal mode (TU, DTU, SAT/CBL, CD, DVD, VCR or TV). Default state is to toggle AMP to SAT/CBL mode.



1. CD player (CD), CD recorder (CDR) system buttons

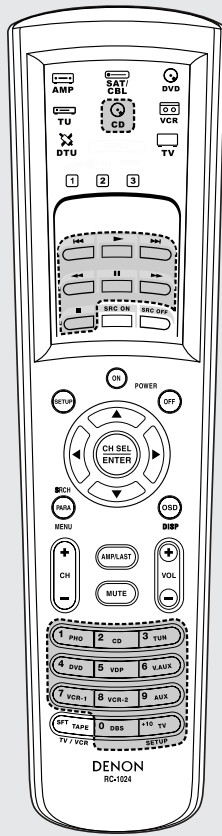

- ◀▶, ▶▶ : Manual search (forward and reverse)
- : Stop
- ▶ : Play
- ◀▶▶▶, ▶▶▶▶ : Auto search (to beginning of track)
- || : Pause
- 0 ~ 9, +10 : Number

※ Default setting = CD

The preset codes of a CDR can be recorded in the CD mode so that the CD recorder can be operated (page 53). It is only possible to set the preset memory for either the CD or CDR.

※ To operate a DENON CDR player, preset "30626" or "31868". To return to operation of a DENON CD player, preset "31867".

2. Tape deck (TAPE) system buttons

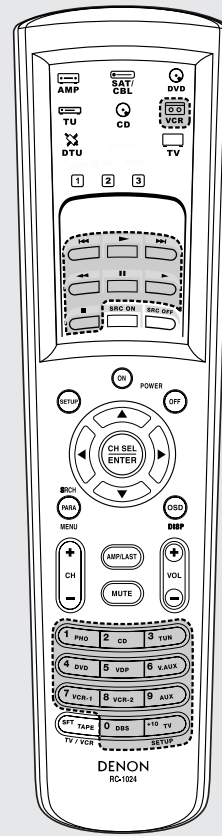

- ◀▶, ▶▶ : Manual search (forward and reverse)
- : Stop
- ▶ : Play
- ◀▶▶▶, ▶▶▶▶ : Auto search (to beginning of track)
- || : Pause
- 0 ~ 9, +10 : Number

※ Default setting = VCR (page 55)

The preset codes of a TAPE can be recorded in the VCR mode so that the tape deck can be operated (page 53). It is only possible to set the preset memory for either the VCR or TAPE.

※ To operate a DENON TAPE, preset "21471".

3. Tuner system buttons

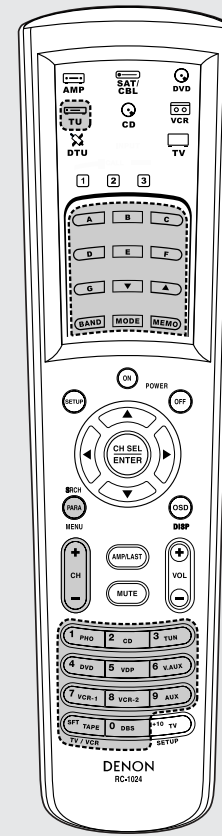

- ▲, ▼ : Tuning up/down
- BAND** : Switch between AM, FM and XM bands
- MODE** : Switch between AUTO and MANUAL
- MEMO** : Preset memory
- SRCH** : Search
- SFT** : Switch preset channel range
- CH +, -** : Preset channel up/down
- A ~ G** : Preset channel range
- 1 ~ 8** : Preset channel
- SRCH** : XM channel direct search
- 0 ~ 9** : XM channel

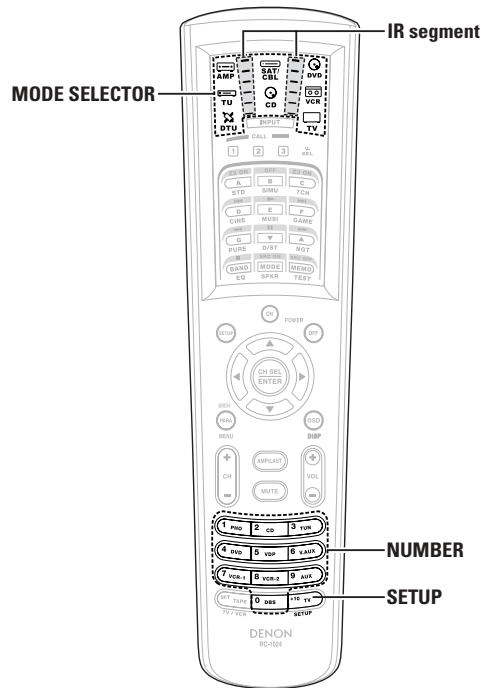

**Preset memory**

The included remote control unit (RC-1024) can be used to operate devices of different brands by registering the preset number corresponding to the brand of your device. For some models the remote control unit or the device may not operate properly. In this case, use the learning function (page 56) to store your device's remote control signals in the included remote control unit.

**1 Press the MODE SELECTOR button for the component you want to preset.**

※ Presetting is not possible for the AMP, ZONE2, ZONE3, TUNER and SYSTEM CALL modes.

**2 Press and hold the SETUP button for at least three seconds.**

• The top IR segment blinks twice.

**3 Referring to the included List of Preset Codes (End of this manual), press the NUMBER button to input the preset code (a 5-digit number) for the manufacturer of the component whose signals you want to store in the memory.**

- The top IR segment blinks once after each button press.
- If the remote recognizes the manufacturer's code, the IR segment blinks twice.

※ You have 10 seconds to press each digit. If it takes longer than that, the remote "times out" and you must begin again.

**NOTE:**

- Depending on the model and year of manufacture, this function cannot be used for some models, even if the your device is listed on the included list of preset codes.
- Some manufacturers use more than one type of remote control code. Refer to the included list of preset codes to change the number and check it out.

**■ The preset codes are as follows upon shipment from the factory and after resetting:**

- TV, VCR .....HITACHI
- CD, DVD .....DENON
- SAT .....RCA

DVD preset codes			
	41470 (default)	40490	
DENON Model No.	DVD-555	DVD-2910	DVD-800
	DVD-755	DVD-3800	DVD-1600
	DVD-900	DVD-3910	DVD-2000
	DVD-910	DVD-5900	DVD-2500
	DVD-955	DVD-5910	DVD-3000
	DVD-1000	DVD-9000	DVD-3300
	DVD-1200	DVM-715	
	DVD-1500	DVM-1800	
	DVD-1710	DVM-1805	
	DVD-1910	DVM-1815	
	DVD-2200	DVM-2815	
	DVD-2800	DVM-4800	
	DVD-2800II		
	DVD-2900		

**Operating a component stored in the preset memory**

**1 Press the MODE SELECTOR button for the component you want to operate.**

**2 Operate the component.**

- ※ For details, refer to the component's operating instructions.
- ※ Some models cannot be operated with this remote control unit.



• For the DVD player remote control buttons, function names may differ according to manufacturer. Compare with the remote control operation of the various components.

1. DVD player (DVD), DVD recorder (DVDR) system buttons

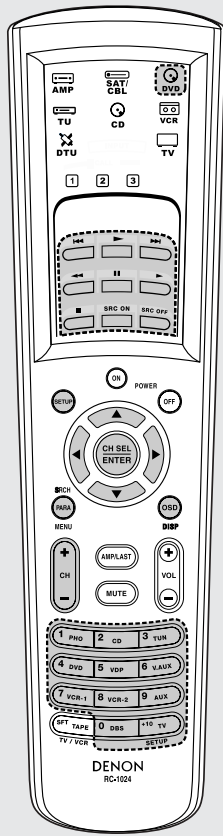

- SRC ON** : Power on
- SRC OFF** : Power off
- ◀◀, ▶▶** : Manual search (forward and reverse)
- : Stop
- ▶** : Play
- ◀◀, ▶▶** : Auto search (to beginning of track)
- ||** : Pause
- SETUP** : Setup
- MENU** : Menu
- ▲, ▼, ◀, ▶** : Cursor up, down, left and right
- ENTER** : Enter
- DISP** : Display
- CH +, -** : Switch channels +, -
- 0 ~ 9, +10** : Number

※ Default setting = DVD  
 The preset codes of a DVDR can be recorded in the DVD mode so that the DVD recorder can be operated.  
 It is only possible to set the preset memory for either the DVD or DVDR.

2. Satellite (SAT) tuner, cable (CABLE) system buttons

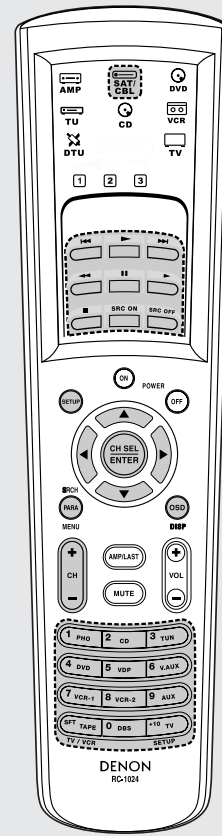

- SRC ON** : Power on
- SRC OFF** : Power off
- SETUP** : Setup
- DISP** : Guide
- MENU** : Menu
- ▲, ▼, ◀, ▶** : Cursor up, down, left and right
- ENTER** : Enter
- CH +, -** : Switch channels +, -
- 0 ~ 9, +10** : Number

※ When there are codes usable for the preset device, those codes are sent when the buttons below are pressed. If not, by default the DVD codes are punched through. If the punch through setting is made after the preset memory is set, the codes are sent with priority.

- ◀◀, ▶▶** : Manual search (forward and reverse)
- : Stop
- ▶** : Play
- ◀◀, ▶▶** : Auto search (cue)
- ||** : Pause

※ Default setting = SAT  
 The preset codes of a CABLE can be recorded in the SAT/CBL mode so that the cable device can be operated.  
 It is only possible to set the preset memory for either the SAT or CBL.

3. Video deck (VCR) system buttons

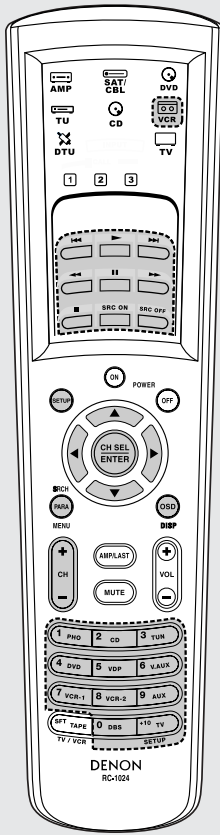

- SRC ON** : Power on
- SRC OFF** : Power off
- ◀▶** : Manual search (forward and reverse)
- : Stop
- ▶** : Play
- ◀▶▶▶** : Auto search (to beginning of track)
- ||** : Pause
- SETUP** : Setup
- MENU** : Menu
- ▲, ▼, ◀, ▶** : Cursor up, down, left and right
- ENTER** : Enter
- DISP** : Guide
- CH +, -** : Switch channels +, -
- 0 ~ 9, +10** : Number

4. Monitor TV (TV), system buttons

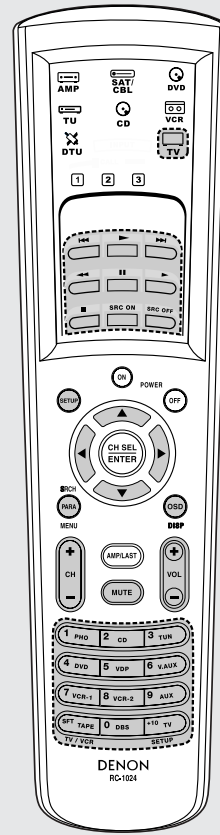

- SRC ON** : Power on
- SRC OFF** : Power off
- SETUP** : Setup
- MENU** : Menu
- ▲, ▼, ◀, ▶** : Cursor up, down, left and right
- ENTER** : Enter
- DISP** : Guide
- CH +, -** : Switch channels +, -
- 0 ~ 9, +10** : Number
- TV/VCR** : Switch between TV and video player

※ When there are codes usable for the preset device, those codes are sent when the buttons below are pressed. If not, by default the DVD codes are punched through. If the punch through setting is made after the preset memory is set, the codes are sent with priority.

- ◀▶** : Manual search (forward and reverse)
- : Stop
- ▶** : Play
- ◀▶▶▶** : Auto search (cue)
- ||** : Pause

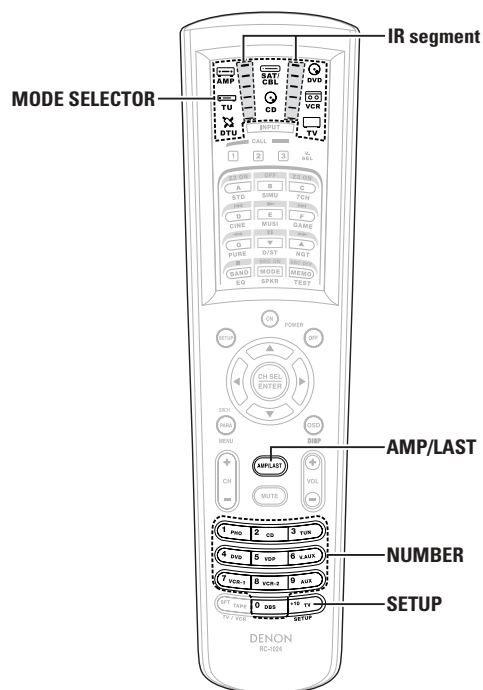

### Learning function

If an AV component is not a DENON product, or if it cannot be operated via codes provided in the AVR-4306 remote control's internal preset memory, or if its codes cannot be successfully learned by the AVR-4306 remote control, then you should use the remote control that was supplied with that AV component to operate the component.

### 1 Press and hold the **SETUP** button for at least three seconds.

- The IR segment blinks twice.

### 2 Press the **9, 7, 5** button (9 → 7 → 5) to select Learning setup.

- The IR segment blinks twice, indicating the remote is in Learning set up mode.

### 3 Press the **MODE SELECTOR** button for the component you want to learned.

- ※ Learning is not possible for the AMP, ZONE2, ZONE3 and SYSTEM CALL modes.

### 4 Press the button that you wish to be learned.

- The display will go off and the unit will enter the learning standby mode.

- ※ If a button that cannot be "learned" is pressed, the IR segment lights and the learning setup mode is cancelled.

- ※ The **AMP/LAST** button cannot be "learned".

### 5 Point the remote control units directly at each other and press and hold in the button on the other remote control unit which you want to "learn".

- The display turns on again and the IR segment blinks twice to indicate that the code is successfully captured.

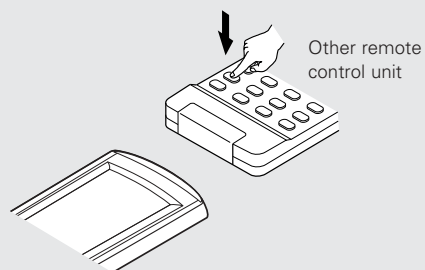

- ※ Other buttons can be "learned" by repeating steps 4 and 5.
- ※ The mode can be switched by pressing a **MODE SELECTOR** button.
- ※ If the IR segment displays one long flash, a leaning error has occurred. Try repeating this step again until a successful capture occurs.

### 6 Press and hold the **SETUP** button for at least three seconds to exit programming.



- To cancel the learning setup mode, press the **SETUP** button for at least three seconds.
- Do not try to learn anything to the **SETUP** button.

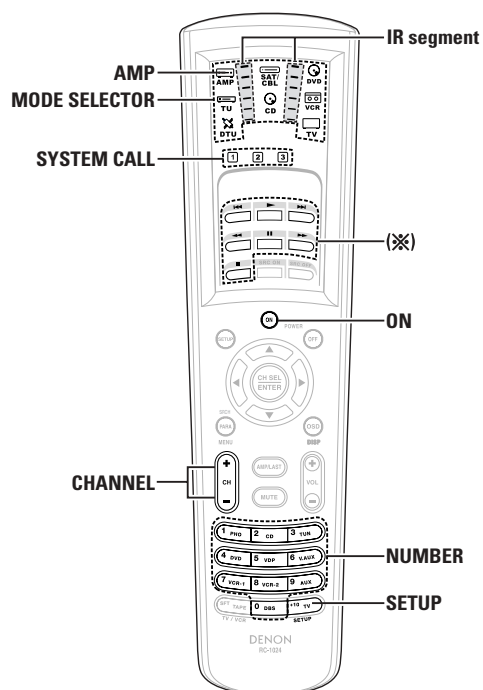

### System call

The accessories remote control unit is equipped with "system call" function allowing a series of remote control signals to be transmitted by pressing a single button.

This function can be used for example to turn on the amplifier's power, select the input source, turn on the monitor or TV's power, turn on the source component's power and set the source to the play mode, all at the touch of a single button.

### System call buttons

- Up to 32 signals each can be stored at the **SYSTEM CALL 1 ~ 3** buttons.
- The System Call function can be used in the SYSTEM CALL mode.

### Storing system call signals

- 1 Press and hold the SETUP button for at least three seconds.**
  - The IR segment blinks twice.
- 2 Press the 9, 7, 8 button (9 → 7 → 8) to select system call setting.**
  - The IR segment blinks twice.
- 3 Press the SYSTEM CALL button (1 to 3) you want to register the system call.**
- 4 Press the button you want to register.**
  - The IR segment blinks once after each button press.

※ The mode can be switched by pressing a **MODE SELECTOR** button.
- 5 Repeat steps 4 to register the desired buttons.**
  - ※ Up to 32 signals each can be stored at the SYSTEM CALL 1 ~ 3.
- 6 Press and hold the SETUP button for at least three seconds to register the system call.**
  - The IR segment blinks twice.

#### NOTE:

- The remote control signals of the buttons pressed while registering the system call signals are emitted, so be careful not to operate the components accidentally (cover the remote sensors, for example).

### Using the system call function

- 1 Press the AMP button to select SYSTEM CALL mode.**
- 2 Press the SYSTEM CALL button (1 to 3) at which the system call signals have been stored.**
  - The stored signals are transmitted successively.

### Punch through

Buttons used in the CD, DVD, and VCR modes can be assigned to the buttons which are not normally used in the TV and SAT/CBL modes.

For example, when the DVD mode is set to the punch through mode in the TV mode, the DVD mode's PLAY (▶), STOP (■), MANUAL SEARCH (◀◀, ▶▶), AUTO SEARCH (◀◀, ▶▶) and PAUSE (||) button's signals are sent in the TV mode. — (※)

- 1 Press and hold the SETUP button for at least three seconds.**
  - The IR segment blinks twice.
- 2 Press the 9, 8, 4 button (9 → 8 → 4) to select punch through setting.**
  - The IR segment blinks twice.
- 3 Select the MODE SELECTOR button (CD, DVD or VCR) you want to punch through.**
- 4 Press the button you want to punch through (▶, ■, ◀◀, ▶▶, ◀◀, ▶▶ or ||).**
- 5 Repeat step 4.**
- 6 Press the MODE SELECTOR button (TV or SAT/CBL) for which you want to set the punch through.**
- 7 Press and hold the SETUP button for at least three seconds.**
  - The IR segment blinks twice.

### Setting the back light's lighting time

**1** Press and hold the **SETUP** button for at least three seconds.

- The IR segment blinks twice.

**2** Press the **9, 7, 3** button (9 → 7 → 3) to select **Light setup**.

- The IR segment blinks twice.

**3** Press the **NUMBER** button (1 to 5) you want to adjust the lighting time (5 sec ~ 25 sec).

#### ■ Lighting time

- 1 : 5 sec
- 2 : 10 sec (factory default)
- 3 : 15 sec
- 4 : 20 sec
- 5 : 25 sec

- The IR segment blinks twice as confirmation.

### Setting the ambient light sensor

The included remote control unit (RC-1024) has the ambient light sensor which allows the EL display brightness to automatically adjust depending on how light or dark the amount of incandescent light in the room is. Default state of the ambient light sensor is "OFF" (disable).

**1** Press and hold the **SETUP** button for at least three seconds.

- The IR segment blinks twice.

**2** Press the **9, 7, 9** button (9 → 7 → 9).

- The IR segment blinks twice.

**3** Press the **ON** button.

- The IR segment blinks two or four times.

※ Two blinks indicates that ambient light feature was disabled, and is now enabled. Four blinks indicates that ambient light feature was enabled, and is now disabled.



- If you want to set the brightness of the display manually, set to "OFF" (default).

### Setting the brightness

- The brightness of the display can be adjusted in 5 levels.
- The default brightness setting is level 3 (level 5 = brightest).

**1** Press and hold the **SETUP** button for at least three seconds.

- The IR segment blinks twice.

**2** For 1 brightness step increase:  
Press the **CHANNEL +** button.  
-1

**2** For 1 brightness step decrease:  
Press the **CHANNEL -** button.  
-2

**3** Press and hold the **SETUP** button to exit programming.

- The IR segment twice as confirmation.

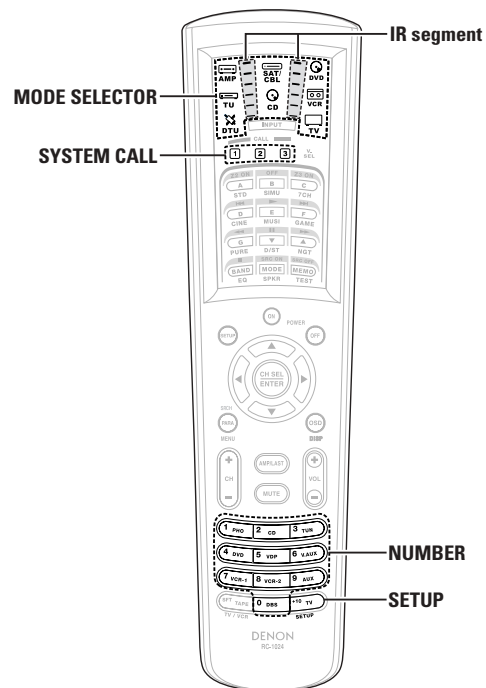

## Resetting

### Resetting the single learned button

- 1** Press and hold the **SETUP** button for at least three seconds.
  - The IR segment blinks twice.
- 2** Press the **9, 7, 6** button (9 → 7 → 6).
  - The IR segment blinks twice.
- 3** Press the **MODE SELECTOR** button.
- 4** Press the learned button you want to reset twice.
  - The IR segment blinks twice.

※ Other key can be deleted by repeating steps 1 to 4.

### Resetting all learned buttons

- 1** Press and hold the **SETUP** button for at least three seconds.
  - The IR segment blinks twice.
- 2** Press the **9, 7, 6** button (9 → 7 → 6).
  - The IR segment blinks twice.
- 3** Press the **MODE SELECTOR** button you want to reset twice.
  - The IR segment blinks twice.

### Resetting the system call buttons

- 1** Press and hold the **SETUP** button for at least three seconds.
  - The IR segment blinks twice.
- 2** Press the **9, 7, 8** button (9 → 7 → 8).
  - The IR segment blinks twice.
- 3** Press the **SYSTEM CALL** button (1 to 3) you want to reset.
- 4** Press and hold the **SETUP** button for at least three seconds to clear the system call.
  - The IR segment blinks twice.

### Resetting the punch through setting

- 1** Press the **MODE SELECTOR** button (TV or SAT / CBL) you want to reset.
- 2** Press and hold the **SETUP** button for at least three seconds.
  - The IR segment blinks twice.
- 3** Press the **9, 8, 4** button (9 → 8 → 4) to select a setting.
  - The IR segment blinks twice.
- 4** Press and hold the **SETUP** button for at least three seconds to reset the punch through setting.
  - The IR segment blinks twice.

### All reset function

- 1** Press and hold the **SETUP** button for at least three seconds.
  - The IR segment blinks twice.
- 2** Press the **9, 8, 1** button (9 → 8 → 1).
  - The IR segment blinks four times.
  - Clear the entire system memory, which will restore the remote control unit to the factory default settings.

※ Only use this if you wish to clear all customized settings and memories and restore the unit to its out-of-the-box factory default settings.



**Multi zone music entertainment system**

- When the outputs of the “ZONE2 (ZONE3)” OUT terminals are wired and connected to power amplifiers installed in other rooms, different sources can be played in rooms other than the MAIN ZONE in which this unit and the playback devices are installed. (Refer to ZONE2 (ZONE3) on the diagram below.)
- Settings can be made at “Power Amp Assign” in the “System Setup Menu” so that the same source as the ZONE2 (ZONE3) pre-out terminals can be played from the speakers connected to the ZONE2 (ZONE3) speaker terminals (page 76).
- When a sold separately room-to-room remote control unit (DENON RC-616, 617 or 618) is wired and connected between the MAIN ZONE and ZONE2 (ZONE3), the remote-controllable devices in the MAIN ZONE can be controlled from ZONE2 (ZONE3) using the remote control unit.
- ※ To control playback devices other than the ones above, either use that device’s remote control unit or preset a separately sold programmable remote control unit.



- For instructions on installation and operation of separately sold devices, refer to the devices’ operating instructions.

**Multi-zone playback using the ZONE2 and ZONE3 PREOUT terminals**

**■ When using the power amplifier as the MAIN ZONE output**

- The AVR-4306 is equipped with pre-out terminals for which the volume is adjustable and video output terminals (composite and S-Video) as the ZONE2 output terminals, and variable output level as the ZONE3 output terminals.

**[System configuration and connections example]**

Using external amplifier.

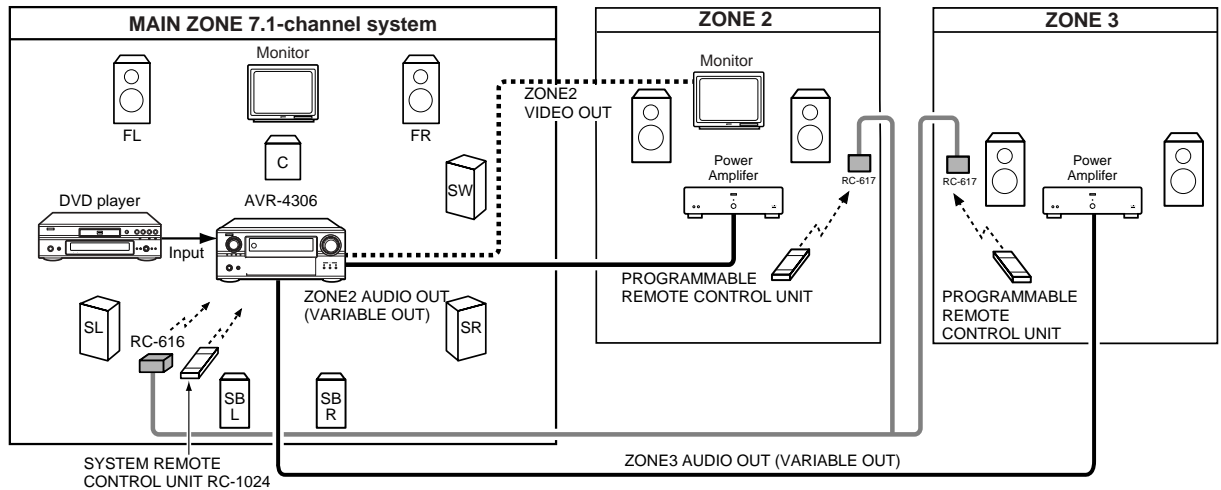

- : MULTI SOURCE VIDEO signal cable
- : MULTI SOURCE AUDIO signal cable
- : ROOM-TO-ROOM REMOTE CONTROL SYSTEM (separately sold) control line

※ Refer to “Connections” (page 22).

**Multi-zone playback using the SPEAKER terminals**

**■ When using the SURROUND BACK amplifier as the ZONE2/ZONE3 output**

- When the surround back's power amplifier is assigned to the ZONE2 or ZONE3 output channel at "Power Amp Assign" in the "System Setup Menu", the surround back speaker terminals can be used as the ZONE2 or ZONE3 speaker out terminals (page 76).

**[System configuration and connections example]**

Using external amplifier as the ZONE2 and using this AVR-4306 internal amplifier as the ZONE3.

**[System configuration and connections example]**

Using external amplifier as the ZONE3 and using this AVR-4306 internal amplifier as the ZONE2.

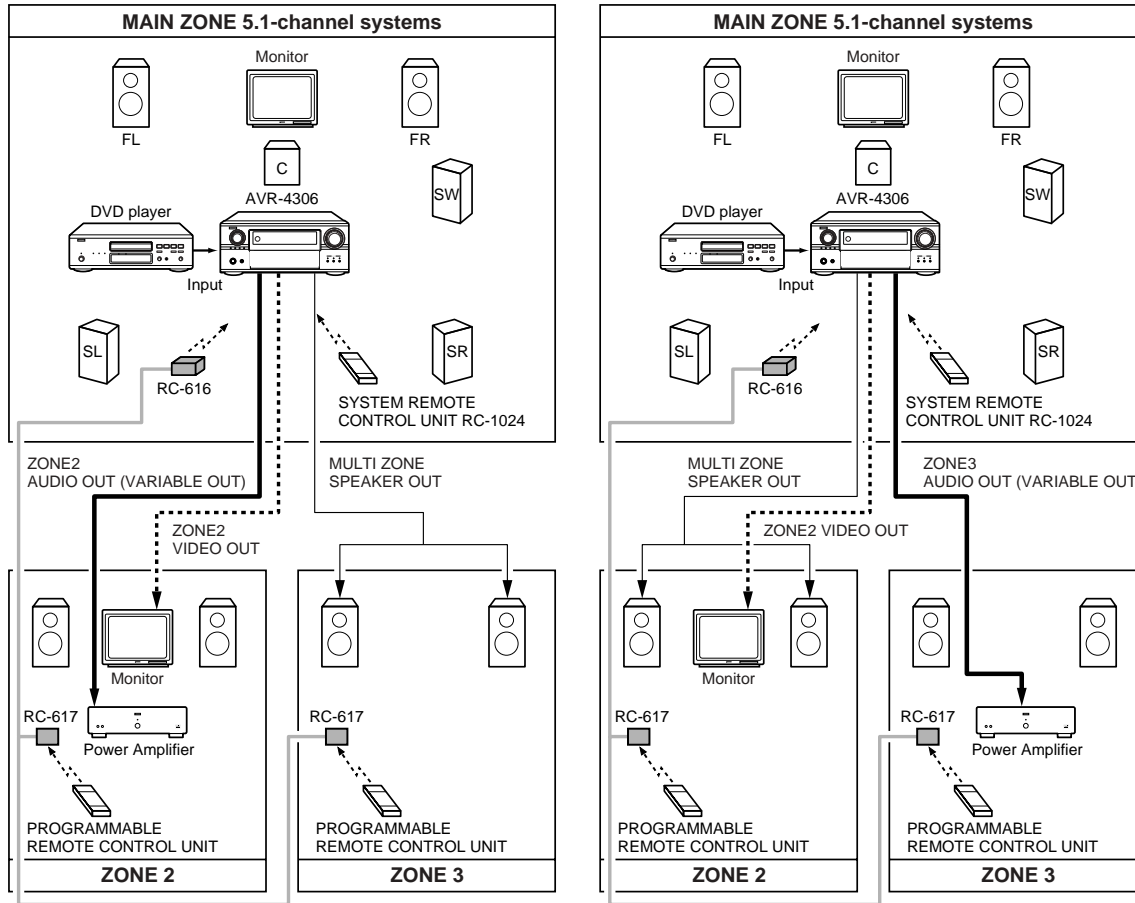

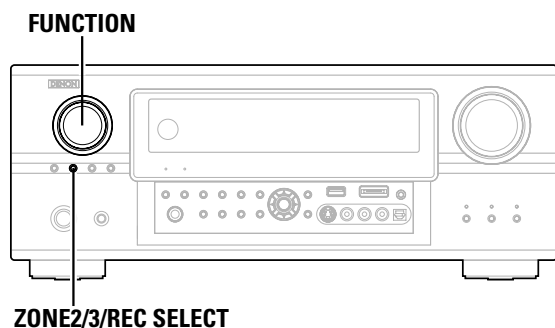

ZONE2/3/REC SELECT

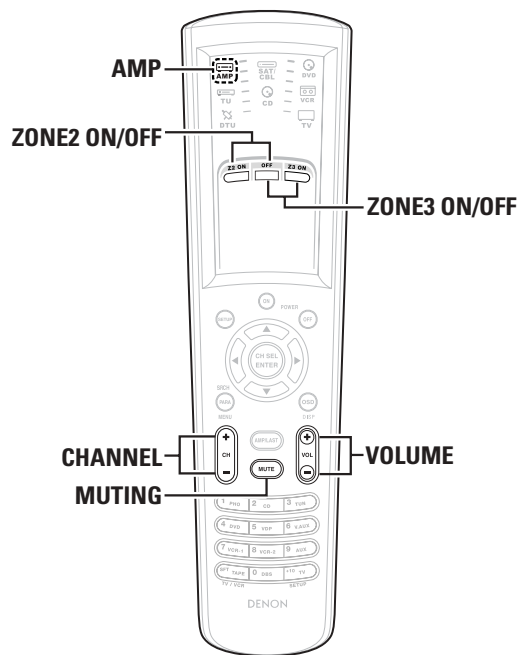

**Outputting a program source to amplifier, etc., in the ZONE2 (or ZONE3) room (ZONE2 or ZONE3 SELECT mode)**

**1** Press the **ZONE2/3/REC SELECT** button to display the “ZONE2 SOURCE” or “ZONE3 SOURCE” on the display.

- If the “ZONE2 SOURCE” is selected, the MULTI indicator lights.

※ The display switches as follows each time the button is pressed.

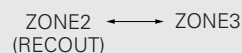

**2** With “ZONE2 SOURCE” or “ZONE3 SOURCE” displayed, turn the **FUNCTION** knob to select the source you want to output appears on the display.

**3** Start playing the source to be output.

※ For operating instructions, refer to the manuals of the respective components.



- If and only if the digital signal being input from the digital input terminal (optical/coaxial) is a PCM signal, it is output from the ZONE2 and ZONE3 audio output terminals.
- When certain digital signals are being input, noise may be output from the ZONE2 and ZONE3 audio output terminals.
- When “DENON LINK” is assigned at “Digital In Assign”, it is not possible to output the PCM signal and Network Audio signals (Internet radio, music server, USB) being input from the digital audio input terminal from the ZONE2 and ZONE3 audio output terminals (page 67).
- The signals of the source selected in the ZONE2 mode are also output from the VCR-1, VCR-2 and CDR/TAPE recording output terminals.
- About the MULTI ZONE connections (page 60, 61).

**Remote control unit operations during multi-source playback**

**1** Select the zone which you want to operate pressing the **AMP** button.

**2** Press the **ZONE2 (ZONE3) ON** button to turn on the zone power.

※ Press the **OFF** button to turn off the zone power.

**3** Select the input source you wish to output.

※ When the input source is set to TUNER, the preset channel can be selected using the **CHANNEL +** and **-** buttons on the remote control unit.

**4** The volume of the outputs of the different zones can be adjusted with the **VOLUME** button on the remote control unit.

※ The output level can be controlled only if the zone volume level is set “variable” at “Volume Control” in the “System Setup Menu” (page 77).

※ DEFAULT VOLUME SETTING  
 ZONE2 : -40 dB  
 ZONE3 : -40 dB

※ The zone volume can be adjusted within the range of -70 to 18 dB, in steps of 1 dB.



- Press the **MUTING** button to mute the audio temporarily. The muting level is same as set with “Volume Control”.
- Cancelling muting mode: Press the **MUTING** button again, or press the **VOLUME** button on the remote control unit.

Other function

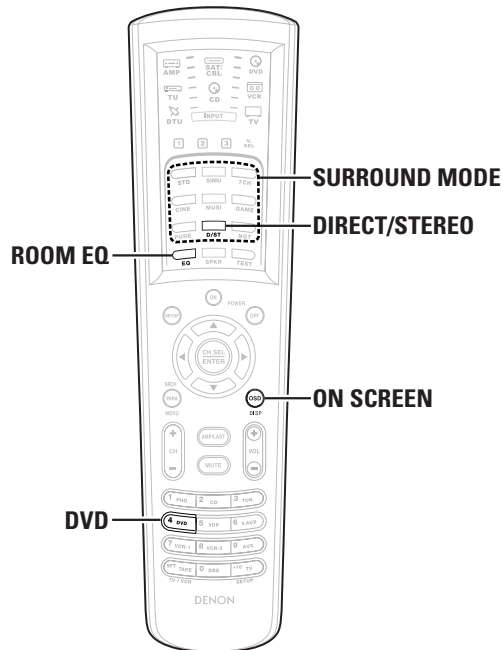
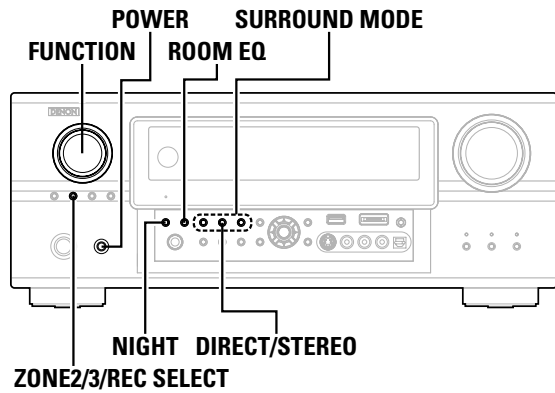

Playing Super Audio CDs with DENON LINK

**1** Select the input source to which DENON LINK was assigned at the “Digital In Assign” (page 67) in the system setup.

Example: DVD

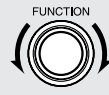

(Main unit)



(Remote control unit)

- The DENON LINK indicator lights.



**2** Select the surround mode.

Example: DIRECT



(Main unit)

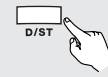

(Remote control unit)

**3** Start playback on the selected component.

- The DSD indicator lights.

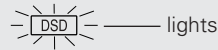

- ※ For operating instructions, refer to the component’s manual.
- ※ “DSD DIRECT” is shown on the display when playing DSD 2-channel signals in the DIRECT mode. “DSD MULTI DIRECT” is displayed when playing DSD multi-channel signals in the DIRECT mode (SB CH OUT “OFF”).

When playing DSD signals in the DIRECT or PURE DIRECT mode, the DSD signals are converted into analog signals. When playing in other surround modes, the DSD signals are first converted into PCM signals. The input signal and playing status can be checked by pressing the **ON SCREEN** button on the remote control unit.

Example:

When DSD multi-channel signals are played in the DIRECT mode

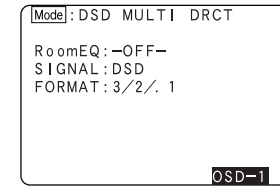

Example:

When DSD multi-channel signals are played in the 7CH STEREO mode

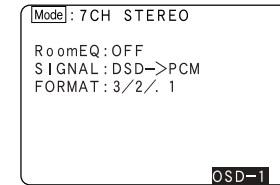

## Multi-source recording / playback

### ■ Playing one source while recording another (REC OUT mode)

**1** Press the **ZONE2/REC SELECT** button until “ZONE2 SOURCE” appears on the display.

**2** With “ZONE2 SOURCE” displayed, turn the **FUNCTION** knob until “RECOUT SOURCE” appears on the display.

- The REC indicator lights.

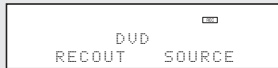

※ The function switches as shown below when the **FUNCTION** knob is turned.

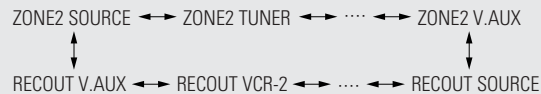

**3** With “RECOUT SOURCE” displayed, turn the **FUNCTION** knob to select the source you wish to record.

**4** Set the recording mode.

※ For operating instructions, refer to the manual of the component on which you want to record.



- To cancel, turn the **FUNCTION** knob and select “SOURCE”.
- Recording sources other than digital inputs selected in the REC OUT mode are also output from the ZONE2 preout terminals.
- If and only if the digital signal being input from the digital input terminal (optical/coaxial) is a PCM signal, it is output from the analog REC OUT terminals.
- When “DENON LINK” is assigned at “Digital In Assign”, it is not possible to output the PCM signal and Network Audio signals (Internet radio music server, USB) being input from the digital audio input terminal from the analog REC OUT terminals (🔍 page 67).
- When the REC OUT mode is selected, the **ZONE2** button on the remote control unit cannot be operated.
- Network Audio (Internet radio, music server or USB) signals are not output from the OPTICAL 3 OUT and OPTICAL 4 OUT terminals.

## Last function memory

- This unit is equipped with a last function memory which stores the input and output setting conditions as they were immediately before the power is switched off. This function eliminates the need to perform complicated resetting when the power is switched on.
- The unit is also equipped with a back-up memory. This function provides approximately one week of memory storage from when the main unit’s power switch is off and with the power supply cord disconnected.

## Initialization of the microprocessor

- In very rare instances, the AVR-4306 internal microprocessor might lock up, or otherwise cause mis-operation. This might be caused due to an AC line surge or line spike noise, or by static electric discharge on or nearby the unit, or to connected components. If the condition cannot be corrected by powering off the unit, including disconnection of the power supply cord for a period of ten minutes and subsequent re-connection, then the unit may have to be re-initialized. Doing so will restore the microprocessor to its original out-of-the-box state, with all custom memories and settings erased, and the original factory default settings restored. Only use this procedure if you are sure that the microprocessor requires re-initialization.

**1** Switch off the unit using the main unit’s **POWER** switch.

**2** Hold the following **ROOM EQ** button and **NIGHT** button, and turn the main unit’s **POWER** switch on.

**3** Check that the entire display is flashing with an interval of about 1 second, and release your fingers from the 2 buttons.

- The microprocessor will be initialized.



- If step 3 does not work, start over from step 1.
- If the microprocessor has been reset, all the settings are reset to the default values (the values set upon shipment from the factory).

# Advanced Setup – Part 1

You can customize a variety of system setup so that it may be fitting for your listening environment. For the contents of a system menu and the initial setting of this unit (see page 89 ~ 91).

## Navigating through the System Setup Menu

You can change setting using the buttons on the front panel or remote control unit.

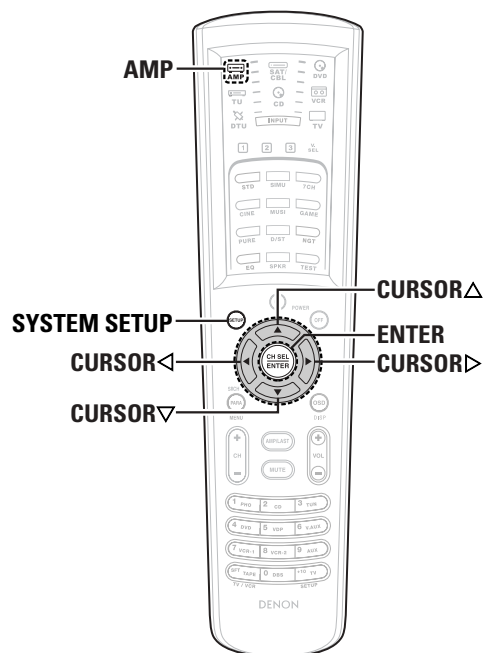
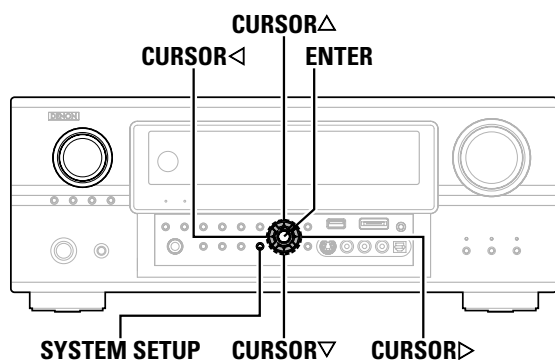

**1** Press the **AMP** button on the remote control unit.

**2** Press the **SYSTEM SETUP** button to display “System Setup Menu”. Press the **CURSOR Δ** or **∇** button to select the menu, then press the **ENTER** button.

**3** Press the **ENTER** button to enter the selected menu.

**4** To change a setting, first select it press the **CURSOR Δ** or **∇** button, and then change the setting press the **CURSOR <** or **>** button.

**5** Press the **ENTER** button to set the new settings.

**6** Press the **SYSTEM SETUP** button to return “System Setup Menu”, and again to return the main screen.

[ On screen display ]

**2** **System Setup Menu**

```

1. Auto Setup/Room EQ
2. Speaker Setup
3. Audio Input Setup
4. Video Setup
5. Advanced Playback
6. Option Setup
7. Network Setup
Exit
    
```

[ Display ]

```

*System Setup
Audio In Setup
    
```

**3** **3. Audio Input Setup**

```

1. Digital In Assign
2. EXT. IN Setup
3. iPod Assign
4. Input Function Lev.
5. Function Rename
6. Tuner Presets
Exit
    
```

```

*Audio In Setup
Digital In
    
```

**4** **3-1. Digital In Assign**

```

CD : <COAX1> Tape : OPT4
DVD : COAX2 V.Aux : OPT5
VDP : OPT1
TV : OFF
DBS : OPT2
VCR-1 : OPT3
VCR-2 : OFF
Default Yes<
    
```

```

*Digital In
CD : <COAX1>
    
```

**6** **System Setup Menu**

```

1. Auto Setup/Room EQ
2. Speaker Setup
3. Audio Input Setup
4. Video Setup
5. Advanced Playback
6. Option Setup
7. Network Setup
Exit
    
```

```

*System Setup
Exit
    
```

**On screen display and front display**

The AVR-4306 is equipped with an intuitive and easy-to-understand on screen display, and is equipped with an alpha-numeric front panel display tube that can also be used to check and adjust settings. We recommend that you use the on screen display when you make system adjustments. Some representative front panel and on screen display examples are shown below.

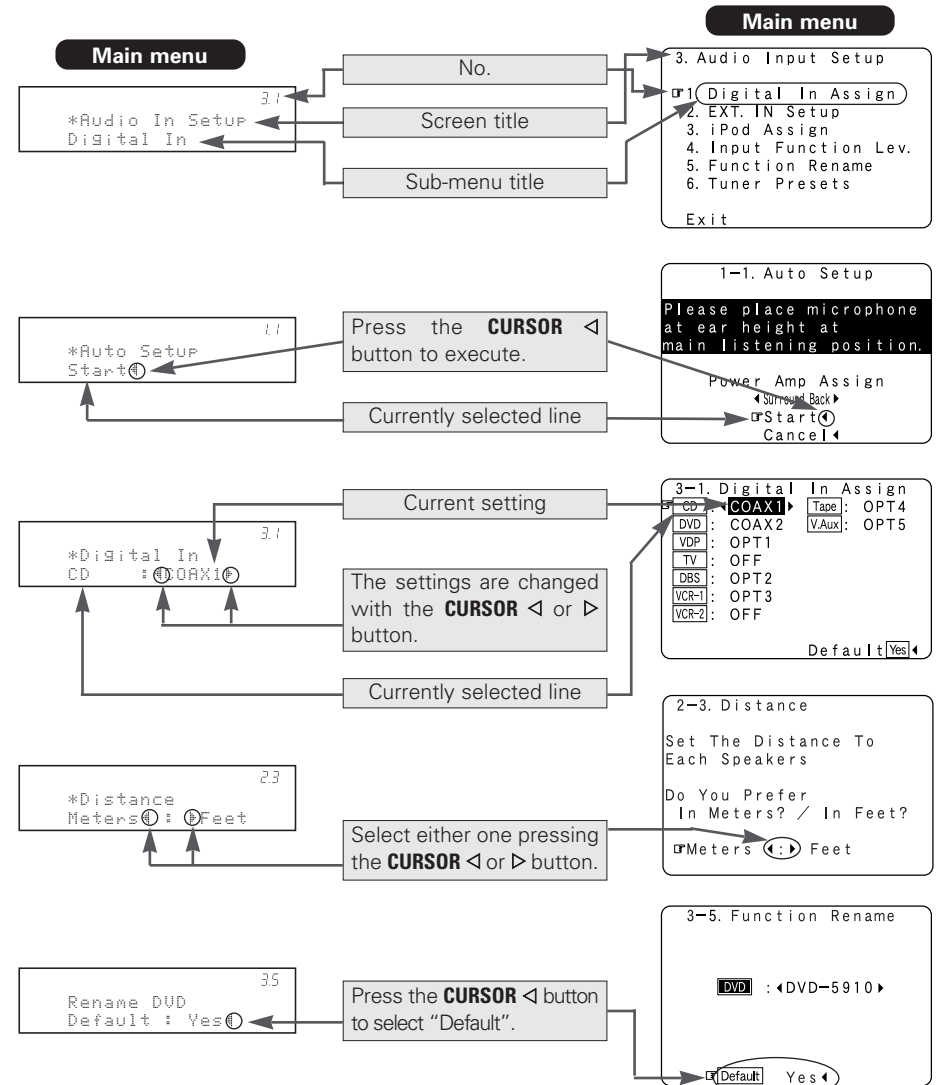
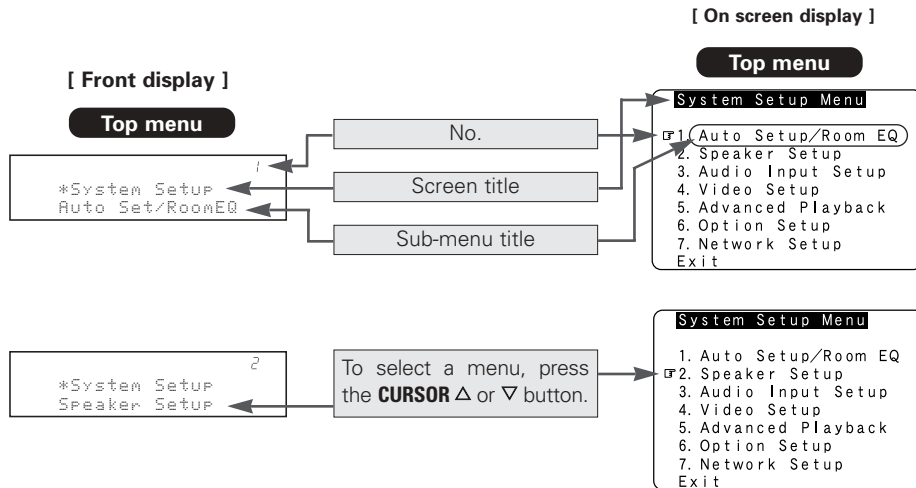

## Audio Input Setup

Make the audio-related settings.

### Setting the Digital In Assignment

This setting assigns the digital input terminals of the AVR-4306 for the different input sources.

#### 1 Press the **CURSOR** $\Delta$ or $\nabla$ button to select “Audio Input Setup” at the “System Setup Menu”, then press the **ENTER** button.

- The “Audio Input Setup” menu screen appears.

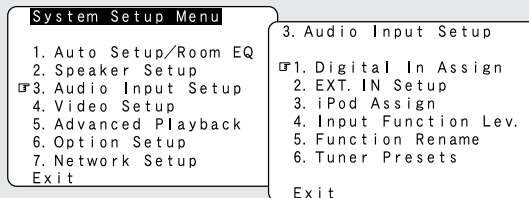

#### 2 Press the **CURSOR** $\Delta$ or $\nabla$ button to select “Digital In Assign”, then press the **ENTER** button.

- The “Digital In Assign” menu screen appears.

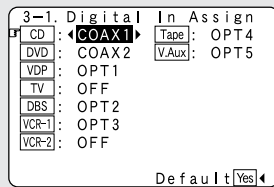

#### 3 Press the **CURSOR** $\Delta$ or $\nabla$ button to select the input source, then press the **CURSOR** $\triangleleft$ or $\triangleright$ button to select the digital input terminal.

- ※ Select from among COAX 1 to 2, OPT 1 to 5.
- ※ If the same digital input terminal is selected, the setting for the input source that was previously assigned switches to “OFF”.
- ※ The HDMI input terminal is displayed when it is assigned to the input source at “HDMI In Assign” (page 71).
- ※ When “Yes” is selected for “Default”, the settings are automatically reset to the default values.

#### 4 Press the **ENTER** button to enter the setting.

- The “Audio Input Setup” menu reappears.



- The OPTICAL 3 and 4 terminals on the AVR-4306’s rear panel are equipped with an optical digital output terminal for recording digital audio signals to a CD recorder, MD recorder, or other digital audio recording deck. Use this for digital recording between a digital audio source (stereo – 2 channel) and a digital audio recorder.
- “PHONO” and “TUNER” cannot be selected on the “Digital In Assign” screen.
- When “DENON LINK” is assigned, PCM signals and Network Audio signals (Internet radio, music server or USB) input from the digital audio input terminal cannot be output from the analog REC OUT terminals or ZONE2 / ZONE3 audio output terminal (page 60, 61 or 64).
- It is not possible to make the “Digital In Assign” settings for the function assigned at “iPod Assign”.

### Setting the DENON LINK

- When a DENON DVD player and the DENON LINK have been connected, be sure to make a setting to “DENON LINK” with “Setting the Digital In Assignment”.
- When the input mode is AUTO and the signals are not be able to transferred by DENON LINK, the unit automatically changes over the input to the selected signals (ANALOG or EXT. IN).
- Refer to “DENON LINK connections” (page 19).

#### 1 Press the **CURSOR** $\Delta$ or $\nabla$ button to select the input source, then press the **CURSOR** $\triangleleft$ or $\triangleright$ button to select “DLINK”.

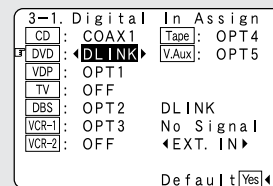

#### 2 Press the **CURSOR** $\Delta$ or $\nabla$ button to select “DLINK” setting, then press the **CURSOR** $\triangleleft$ or $\triangleright$ button to select the input signal (ANALOG or EXT. IN).

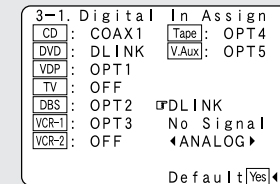

- ※ Select the input for the playback of signals that cannot be transferred by DENON LINK.

### Setting the EXT. IN Setup

- Set the method of playback of the analog input signal connected to the EXT. IN (8CH) terminals.
- Refer to “Connecting the external inputs (EXT. IN) terminals” (page 17).

#### 1 Press the **CURSOR** $\Delta$ or $\nabla$ button to select “EXT. IN Setup” at the “Audio Input Setup” menu, then press the **ENTER** button.

- The “EXT. IN Setup” screen appears.

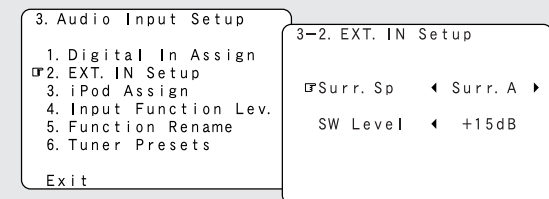

#### 2 Press the **CURSOR** $\Delta$ or $\nabla$ button to select the item to be set, then press the **CURSOR** $\triangleleft$ or $\triangleright$ button to select the parameter.



**Surr. Sp:**

Presets the surround speakers that are used in the EXT. IN mode. Select according to the specifications of the player being used. Also refer to the player's operating instructions.

- **Surr. A:**  
Select when using surround speakers A.
- **Surr. B:**  
Select when using surround speakers B.
- **Surr. A+B:**  
Select when using both surround speakers A and B.

**SW Level:**

Sets the playback level of the analog signal that was input to the EXT. IN subwoofer terminal. Select according to the specifications of the player being used. Also refer to the player's operating instructions. +15dB (default) recommended. (0, +5, +10 and +15 can be selected.)

**3 Press the ENTER button to enter the setting.**

- The "Audio Input Setup" menu reappears.

**Setting the iPod Assignment**

When connecting the iPod via a iPod Dock, it is possible to assign the iPod Dock's audio and video signals to any input terminals on the AVR-4306 and play them.

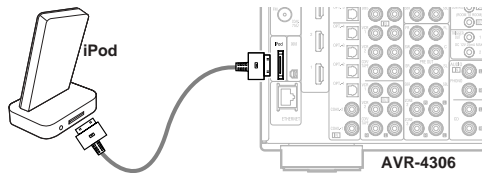

**1 Press the CURSOR Δ or ▽ button to select "iPod Assign" at the "Audio Input Setup" menu, then press the ENTER button.**

- The "iPod Assign" screen appears.

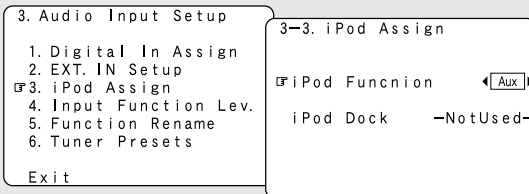

**2 Press the CURSOR ◀ or ▶ button to select the input function to be assigned, then press the ENTER button.**

**Aux:**

This is the factory default setting.  
Connection using a iPod Dock is not possible.

**CD, CDR/TAPE:**

When using a iPod Dock, it is possible to connect with the audio input terminal of the assigned function.

**DVD, VDP, DBS, TV, VCR-1, VCR-2, V.Aux:**

When using a iPod Dock, it is possible to connect with the audio and video input terminals of the assigned function.

**3 Press the CURSOR ▽ button to select "iPod Dock", then press the CURSOR Δ or ▽ button to select "NotUsed" or "Used" and press the ENTER button.**

**Example:** When "CD" is selected for "iPod Function" and "iPod Dock" is set to "Used"

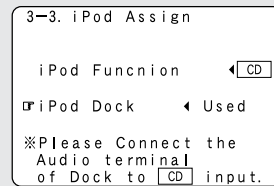

**NotUsed:**

This is the factory default setting. Select this when not using a iPod Dock.  
Connect the iPod cable directly to the iPod.

**Used:**

Select this when using a iPod Dock.  
Connect the iPod Dock's audio and video output connectors to the audio and video input terminals of the function set at "iPod Function".



- When "AUX" is assigned to "iPod Function", the mode switches between "AUX/Net" and "AUX/iPod" each time the **AUX** button is pressed.
- When a function other than "AUX" is assigned to "iPod Function" and "iPod Dock" is set to "NotUsed", remote control operation is possible using the remote control codes of the assigned function.

**Setting the Input Function Level**

- Correct the playback level of the different input sources.
- Adjust the playback levels of the devices connected to the different input sources to the same level to eliminate the need for adjusting the main volume each time the input source is switched.

**1 Press the CURSOR Δ or ▽ button to select "Input Function Lev." at the "Audio Input Setup" menu, then press the ENTER button.**

- The "Input Function Lev." screen appears.

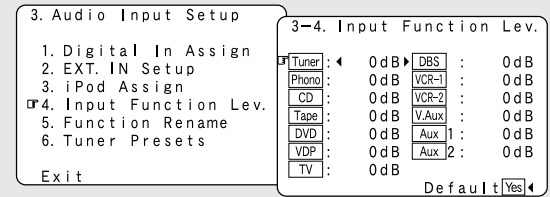

- ※ "Aux1" is setting of "AUX/Net", and "Aux2" is setting of "AUX/iPod".

**2 Press the CURSOR Δ or ▽ button to select the input source, then press the CURSOR ◀ or ▶ button to adjust the level.**

- ※ The level can be adjusted between -12 dB and +12 dB in units of 1 dB.
- ※ When "Yes" is selected for "Default", the settings are automatically reset to the default values.

**3 Press the ENTER button to enter the setting.**

- The "Audio Input Setup" menu reappears.



- After completing this setting, check that the playback levels for the different sources are the same.

## Setting the Function Rename

The names of the input sources displayed on the front display and on the on screen display can be changed. The names or brands of the devices connected to the input sources can be input.

### 1 Press the **CURSOR** $\Delta$ or $\nabla$ button to select “Function Rename” at the “Audio Input Setup” menu, then press the **ENTER** button.

- The “Function Rename” screen appears.

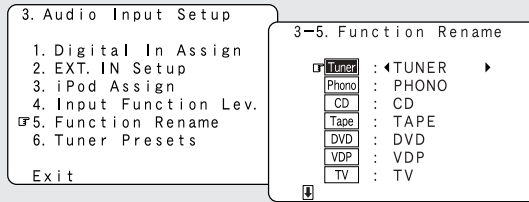

### 2 Press the **CURSOR** $\Delta$ or $\nabla$ button to select the input source whose name you want to change, then press the **CURSOR** $\triangleleft$ or $\triangleright$ button.

- The screen switches to the character input screen.

**Example:** When “DVD” is selected and the **CURSOR**  $\triangleleft$  or  $\triangleright$  button is pressed

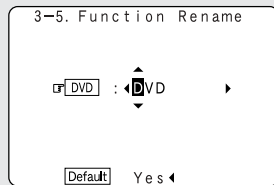

### 3 Press the **CURSOR** $\triangleleft$ or $\triangleright$ button to move the cursor (■) to the character, number, symbol or punctuation mark you wish to input, and press the **CURSOR** $\Delta$ or $\nabla$ button to select that character.

ABCDEFGHIJKLMNOPQRSTUVWXYZ  
 abcdefghijklmnopqrstuvwxyz01234  
 56789  
 !" # % & ' ( ) \* + , - . / : ; < = > ? @ [ \ ] (space)

※ Up to 8 characters can be input.

### 4 Repeat step 3 to input the input source name.

- ※ To reset the input source name to the default value, press the **CURSOR**  $\triangleleft$  or  $\triangleright$  button to highlight the input source display, then press the **CURSOR**  $\nabla$  button.

When “Yes” is selected for “Default”, then press the **CURSOR**  $\triangleleft$  button to reset to the default input source name.

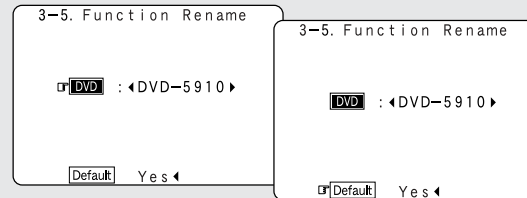

### 5 Once all the characters have been input, press the **ENTER** button.

- The “Function Rename” screen reappears.

- ※ Use the same procedure to change other input source names as well.

### 6 Press the **ENTER** button to enter the setting.

- The “Audio Input Setup” menu reappears.



- “Aux1” is setting of “AUX/Net”, and “Aux2” is setting of “AUX/iPod”.
- When the input source is selected, the display is as shown below.

**Example:** When the name has been changed to “DVD-5910”

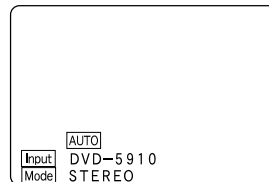

## Tuner Presets

### Auto Preset Memory

Use this to automatically search for FM broadcasts and store up to 56 stations at preset channels A1 to 8, B1 to 8, C1 to 8, D1 to 8, E1 to 8, F1 to 8 and G1 to 8.

### 1 Press the **CURSOR** $\Delta$ or $\nabla$ button to select “Tuner Presets” at the “Audio Input Setup” menu, then press the **ENTER** button.

- The “Tuner Presets” screen appears.

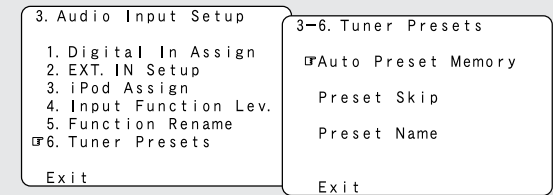

### 2 Press the **CURSOR** $\Delta$ or $\nabla$ button to select “Auto Preset Memory”, then press the **ENTER** button.

- The “Auto Preset Memory” screen appears.

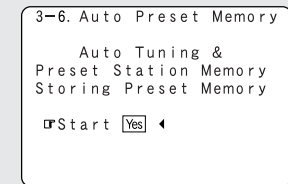

### 3 Press the **CURSOR** $\triangleleft$ button to select “Yes”.

- “Search” flashes on the screen and searching begins.
- “Completed” appears once searching is completed.
- The display automatically switches to the “Tuner Presets” screen.



- If an FM station cannot be preset automatically due to poor reception, use the “Manual tuning” operation (ⓘ page 40) to tune in the station, then preset it using the manual “Preset memory” operation (ⓘ page 41).

### ■ Preset Skip

When selecting preset channels pressing the **CHANNEL +** or **-** button, it is possible to skip specific preset channels.

#### 1 Press the **CURSOR** $\Delta$ or $\nabla$ button to select “Preset Skip” at the “Tuner Presets” screen, then press the **ENTER** button.

- The “Preset Skip” screen appears.

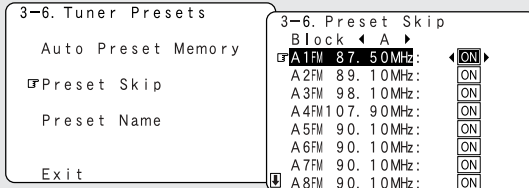

#### 2 Press the **CURSOR** $\Delta$ or $\nabla$ button to select the preset channel you want to skip, then press the **CURSOR** $\triangleleft$ or $\triangleright$ button to select “ON” or “OFF”.

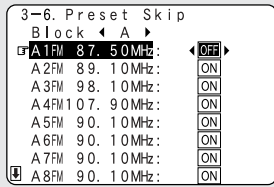

#### 3 When the **CURSOR** $\nabla$ button is pressed at the very bottom of the screen.

- The screen for the next preset memory block appears.

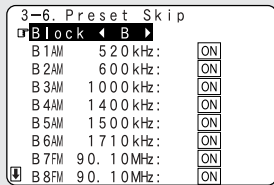

- ※ It is also possible to select the desired preset memory block by selecting “Block” then pressing the **CURSOR**  $\triangleleft$  or  $\triangleright$  button.

#### 4 Repeat steps 2 and 3.

#### 5 Press the **ENTER** button.

- The “Tuner Presets” screen reappears.



- Direct tuning is not possible when “Preset Skip” is set to “OFF”.

### ■ Preset Name

It is possible to input station names, etc., for preset channels (except the XM channel). These names are displayed on the front display and on the on screen display.

#### 1 Press the **CURSOR** $\Delta$ or $\nabla$ button to select “Preset Name” at the “Tuner Presets” screen, then press the **ENTER** button.

- The “Preset Name” screen appears.

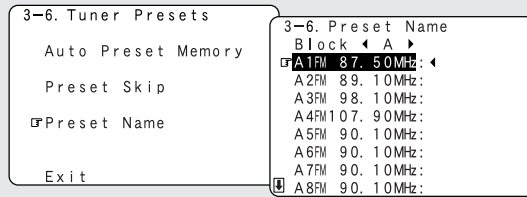

#### 2 Press the **CURSOR** $\Delta$ or $\nabla$ button to select the preset channel whose name you want to change, then press the **CURSOR** $\triangleleft$ or $\triangleright$ button.

- The screen switches to the character input screen.

**Example:** When “A1” is selected and the **CURSOR**  $\triangleleft$  or  $\triangleright$  button is pressed

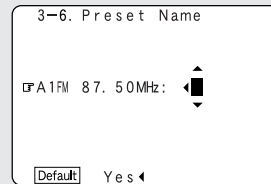

#### 3 Press the **CURSOR** $\triangleleft$ or $\triangleright$ button to move the cursor (■) to the character, number, symbol or punctuation mark you wish to input, and press the **CURSOR** $\Delta$ or $\nabla$ button to select that character.

ABCDEFGHIJKLMNOPQRSTUVWXYZ  
 abcdefghijklmnopqrstuvwxyz012  
 3456789  
 !"#\$%&'()\*+,-./:;<=>?@[ \ ](space)

- ※ Up to 8 characters can be input.

#### 4 Repeat step 3 to input the preset channel name.

- ※ To reset the preset channel name to the default value, press the **CURSOR**  $\triangleleft$  or  $\triangleright$  button to highlight the preset channel display, then press the **CURSOR**  $\nabla$  button. When “Yes” is selected for “Default”, the setting are automatically reset to the default name.

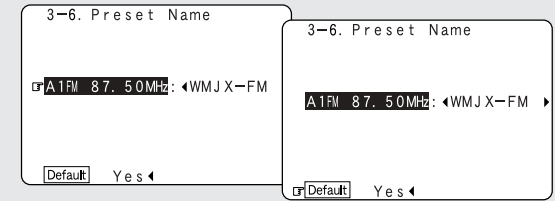

#### 5 Once all the characters have been input, press the **ENTER** button.

- The “Preset Name” screen reappears.

- ※ Use the same procedure to change other input source names as well.

#### 6 When the **CURSOR** $\nabla$ button is pressed at the very bottom of the screen.

- The screen for the next preset memory block appears.

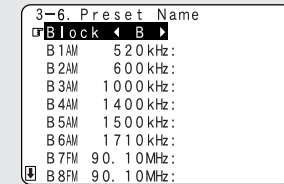

- ※ It is also possible to select the desired preset memory block by selecting “Block” then pressing the **CURSOR**  $\triangleleft$  or  $\triangleright$  button.

#### 7 Press the **ENTER** button.

- The “Tuner Presets” screen reappears.

#### 8 Press the **ENTER** button to enter the setting.

- The “Audio Input Setup” menu reappears.

Video Setup

Make the video-related settings.

Setting the HDMI In Assignment

- This setting assigns the HDMI input terminals for different input sources.
- Set the method for playing the audio signals included in the HDMI input signal.

**1** Press the **CURSOR**  $\Delta$  or  $\nabla$  button to select “Video Setup” at the “System Setup Menu”, then press the **ENTER** button.

- The “Video Setup” menu screen appears.

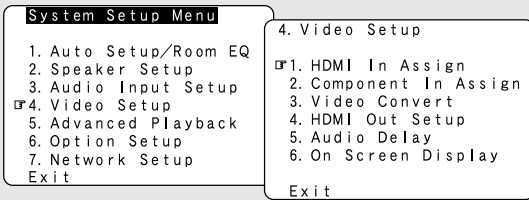

**2** Press the **CURSOR**  $\Delta$  or  $\nabla$  button to select “HDMI In Assign”, then press the **ENTER** button.

- The “HDMI In Assign” screen appears.

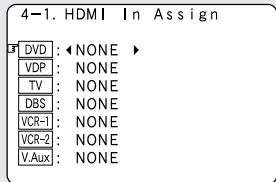

**3** Press the **CURSOR**  $\Delta$  or  $\nabla$  button to select the input source, then press the **CURSOR**  $\triangleleft$  or  $\triangleright$  button to select the input terminal.

- ※ Select from among HDMI1 to 3.
- ※ If the same HDMI input terminal is selected, the setting for the input source that was previously assigned switches to “NONE”.

**4** Press the **CURSOR**  $\Delta$  or  $\nabla$  button to select the method for playing the audio signals included in the HDMI input signal, then press the **CURSOR**  $\triangleleft$  or  $\triangleright$  button to select “AMP” or “TV”.

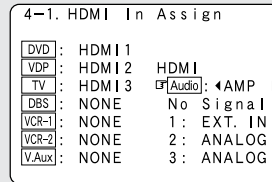

**AMP:**

Play the audio signals on speakers connected to the AVR-4306.

**TV:**

Play the audio signals on a TV connected to the AVR-4306.

**5** Press the **CURSOR**  $\Delta$  or  $\nabla$  button to select the input for the playback of signals when the audio signal of HDMI can not be reproduced, then press the **CURSOR**  $\triangleleft$  or  $\triangleright$  button to select the input signal (ANALOG or EXT. IN).

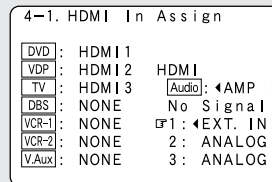

- ※ When the audio signal of HDMI has become unlocked, the unit automatically changes over to the set connector (ANALOG or EXT. IN).
- ※ 1~3 correspond to each HDMI 1~3 input terminal.

**6** Press the **ENTER** button to enter the setting.

- The “Video Setup” menu reappears.



- If a monitor is connected with an HDMI cable but the monitor is not compatible with HDMI audio signal playback, only the video signals are output to the monitor from the AVR-4306 (DVI mode).

Press the **STATUS** button to check which mode is set for outputting HDMI signals from the AVR-4306 (HDMI and DVI modes).

- Audio signals input from the analog and digital terminals are not output to the TV.
- With HDMI, the video and audio signals are transferred simultaneously. When HDMI is assigned to an input source, the digital audio input assignment switches to HDMI along with the video input.

When this setting is made for input sources to which a digital audio input (DENON LINK, OPTICAL etc.) is previously assigned, the digital audio assignment is set to HDMI.

In this case, reassign the digital input using the procedure described at “Digital In Assign” (page 67).

- It is not possible to make the “HDMI In Assign” settings for the function assigned at “iPod Assign”.

Setting the Component In Assignment

This setting assigns the component video input terminal of the AVR-4306 for the different input sources.

**1** Press the **CURSOR**  $\Delta$  or  $\nabla$  button to select “Component In Assign” at the “Video Setup” menu, then press the **ENTER** button.

- The “Component In Assign” screen appears.

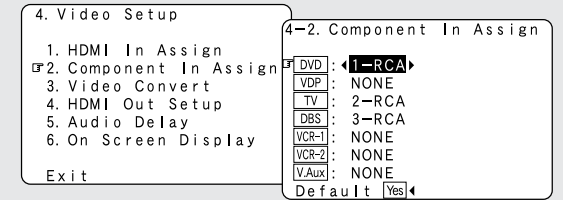

**2** Press the **CURSOR**  $\Delta$  or  $\nabla$  button to select the input source, then press the **CURSOR**  $\triangleleft$  or  $\triangleright$  button to select the component video input terminal.

- ※ Select from among 1-RCA to 3-RCA.
- ※ If the same component video input terminal is selected, the setting for the input source that was previously assigned switches to “NONE”.
- ※ When “Yes” is selected for “Default”, the settings are reset to the default values.

**3** Press the **ENTER** button to enter the setting.  
 • The “Video Setup” menu reappears.

### Setting the Video Convert

Set whether or not to use the video conversion function.

**1** Press the **CURSOR**  $\Delta$  or  $\nabla$  button to select “Video Convert” at the “Video Setup” menu, then press the **ENTER** button.  
 • The “Video Convert” screen appears.

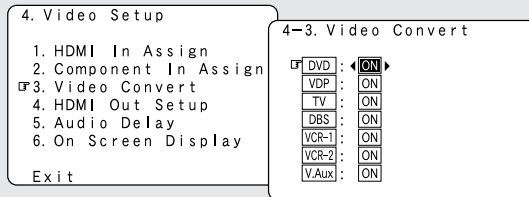

**2** Press the **CURSOR**  $\Delta$  or  $\nabla$  button to select the input source, then press the **CURSOR**  $\triangleleft$  or  $\triangleright$  button to select “ON” or “OFF”.

#### ON:

The convert function operates. When there are multiple input signals, the input signals are detected and the input signal to be output from the video monitor output terminal is selected automatically in the following order: component video, S-Video, composite video.

#### OFF:

The convert function does not operate. The video signal input from the video input terminal is only output to the video monitor out terminal. The S-Video signal input from the S-Video input terminal is only output to the S-Video monitor out terminal. The component input signal input from the component input terminals is only output to the component monitor output terminals.

**3** Press the **ENTER** button to enter the setting.  
 • The “Video Setup” menu reappears.



- Down-converting from the component video signal to the S-Video and composite video signal is possible only when the resolution of a component video signal is 480i / 576i.
- When a non-standard video signal from a game machine or some other source is input, the video conversion function might not operate. If this happens, please set the conversion mode to OFF.
- When the video conversion function has been used, information such as that of text broadcasts which has been added to the video signal might not be output. If this happens, please set the conversion mode to OFF.

### Setting the HDMI Out Setup

- Set whether to use the analog video signals to HDMI conversion function.
- When using this conversion function, set the color format and video range of the signals output from the HDMI terminal.

**1** Press the **CURSOR**  $\Delta$  or  $\nabla$  button to select “HDMI Out Setup” at the “Video Setup” menu, then press the **ENTER** button.

- The “HDMI Out Setup” screen appears.

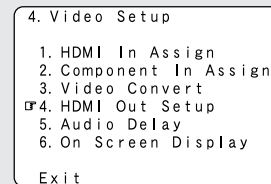

**2** Press the **CURSOR**  $\Delta$  or  $\nabla$  button to select the setting, then press the **CURSOR**  $\triangleleft$  or  $\triangleright$  button to select the parameter.

#### Analog to HDMI Convert:

- **ON:**  
Setting for converting analog video signals into HDMI signals.
- **OFF:**  
Setting for not converting analog video signals into HDMI signals.

#### Aspect:

- **FULL:**  
The video is output while maintaining the aspect ratio of the input video. This mode is suited for playing back 16:9 video.
- **NORMAL:**  
A black band is added to the left and right of the input video and the video is output. This mode is suited for playing back 4:3 video.

#### Resolution:

- **480p/576p:**  
When the video signal being input is a video, S-Video or 480i/576i component video signal, the resolution is converted to 480p/576p and the signal is output from the HDMI MONITOR OUT terminal.
- **1080i:**  
When the video signal being input is a video, S-Video or 480i/576i/480p/576p component video signal, the resolution is converted to 1080i and the signal is output from the HDMI MONITOR OUT terminal.
- **720p:**  
When the video signal being input is a video, S-Video or 480i/576i/480p/576p component video signal, the resolution is converted to 720p and the signal is output from the HDMI MONITOR OUT terminal.
- **Through:**  
The video signal being input is output as such from the HDMI MONITOR OUT terminal without being converted.

**Color Space:**

• **Y Cb Cr:**

The Y Cb Cr format video signals is output via the HDMI output connector.

• **RGB:**

The RGB format video signals is output via the HDMI output connector.

**RGB Mode Setup:**

• **Normal:**

Signals are output via the HDMI output connector with a digital RGB video range (data range) of 16 (black) to 235 (white).

• **Enhanced:**

Signals are output via the HDMI output connector with a digital RGB video range (data range) of 0 (black) to 255 (white).

- ※ When the HDMI connectors are connected, the black may seem to stand out, depending on the TV or the monitor. In this case, set this to “Enhanced”.
- ※ When “Y Cb Cr” is selected under “Color Space”, “RGB Mode Setup” will have no effect.
- ※ The aspect ratio setting is valid when the resolution is set to 1080i or 720p. To output with other resolutions, set the aspect ratio on the TV.
- ※ When “Through” is set, the signal is output with the same resolution as input from the video, S-Video and component video terminals.  
The OSD, however, is output with a resolution of 480i, so use a monitor compatible with this resolution.

**3 Press the ENTER button to enter the setting.**  
• The “Video Setup” menu reappears.



- “Aspect”, “Resolution”, “Color Space” and “RGB Mode Setup” are only displayed when “Analog to HDMI Convert” is set to “ON”.
- When connecting to an HDCP compatible monitor equipped with DVI-D terminal using an HDMI/DVI-D converter cable, the signals are output in RGB format, regardless of the “Color Space” setting.
- To view the on screen display using an HDMI monitor, set “Analog to HDMI Convert” at “HDMI Out Setup” to “ON” (default).

**Setting the Audio Delay**

- When watching a DVD or other video source, the picture on the monitor may seem delayed with respect to the sound. In this case, adjust the audio delay to delay the sound and synchronize it with the picture.
- The audio delay setting is stored separately for each input source.

**1 Press the CURSOR  $\Delta$  or  $\nabla$  button to select “Audio Delay” at the “Video Setup” menu, then press the ENTER button.**

- The “Audio Delay” screen appears.

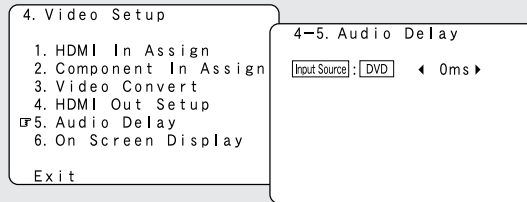

**2 Press the CURSOR  $\triangleleft$  or  $\triangleright$  button to set the delay time (0 ms ~ 200 ms).**

- ※ With a movie source, for example, adjust so that the movement of the actors’ lips is synchronized with the sound.

**3 Press the ENTER button to enter the setting.**  
• The “Video Setup” menu reappears.



- The audio delay setting does not apply when playing in the EXT. IN mode or in the analog input direct mode or stereo mode (Front speaker setting “Large”, TONE DEFEAT “ON” and Room EQ “OFF”).
- By default, this menu is not displayed when no digital signals are being input.

**Setting the On Screen Display (OSD)**

- Use this to turn the on screen display (messages other than the menu screens) on or off.
- Sets the on screen display’s display mode.

**1 Press the CURSOR  $\Delta$  or  $\nabla$  button to select “On Screen Display” at the “Video Setup” menu, then press the ENTER button.**

- The “On Screen Display” screen appears.

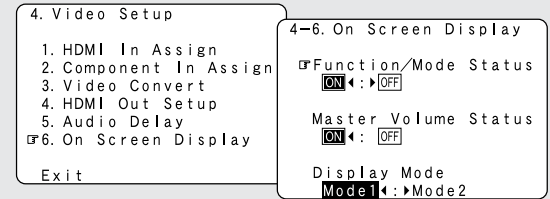

**2 Press the CURSOR  $\Delta$  or  $\nabla$  button to select the item to be set, then press the CURSOR  $\triangleleft$  or  $\triangleright$  button to select the parameter.**

**Function/Mode Status:**

Set whether or not to turn on the on screen display of the input source name and input mode when an input source is selected.signals.

**Master Volume Status:**

Set whether or not to turn on the on screen display of the main volume level when the main volume is operated.

**Display Mode:**

• **Mode 1:**

Flickering is not prevented.

• **Mode 2:**

Prevents flickering of the on screen display when there is no video signal.

Use this mode if the on screen display does not appear in the Mode 1, as may happen according to the TV being used.

**3 Press the ENTER button to enter the setting.**  
• The “Video Setup” menu reappears.

**Advanced Playback**

Makes more detailed audio playback settings.

**Setting the 2ch Direct/Stereo**

Set this when you want to change the speaker settings when the surround mode is set to the 2-channel Direct or Stereo mode.

**1** Press the **CURSOR**  $\Delta$  or  $\nabla$  button to select “Advanced Playback” at the “System Setup Menu”, then press the **ENTER** button.

- The “Advanced Playback” menu screen appears.

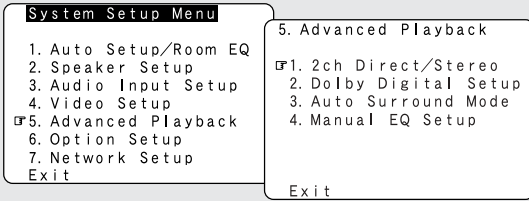

**2** Press the **CURSOR**  $\Delta$  or  $\nabla$  button to select “2ch Direct / Stereo”, then press the **ENTER** button.

- The “2ch Direct / Stereo” screen appears.

**Example:** This screen is displayed in function of the settings made at “Speaker Configuration”, “Subwoofer Setup”, “Distance” and “Crossover Frequency”

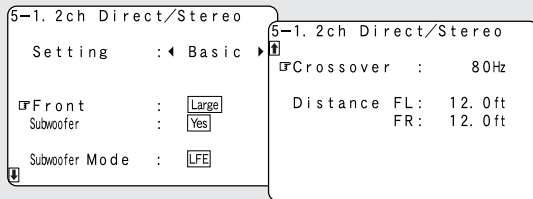

**3** Press the **CURSOR**  $\triangleleft$  or  $\triangleright$  button to select “Custom”.

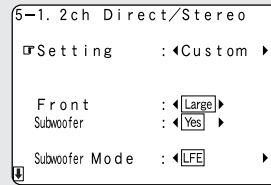

**4** Press the **CURSOR**  $\Delta$  or  $\nabla$  button to select the setting, then press the **CURSOR**  $\triangleleft$  or  $\triangleright$  button to select the parameter.

**5** Press the **ENTER** button to enter the setting.

- The “Advanced Playback” menu reappears.

**Setting the front B speakers when the surround mode is set to the 2-channel Direct or Stereo**

When “Front B” is selected at “Power Amp Assign” and “Custom” is selected at this setting, the “Front B” setting is displayed.

- ※ To play signals from the Front B speaker when in the 2-channel Direct or Stereo mode, set “Used”.

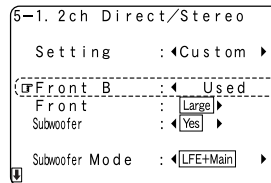

**Setting the Dolby Digital Setup**

Sets the down-mixing method when not using a center speaker or surround speakers.

**1** Press the **CURSOR**  $\Delta$  or  $\nabla$  button to select “Dolby Digital Setup” at the “Advanced Playback” menu, then press the **ENTER** button.

- The “Dolby Digital Setup” screen appears.

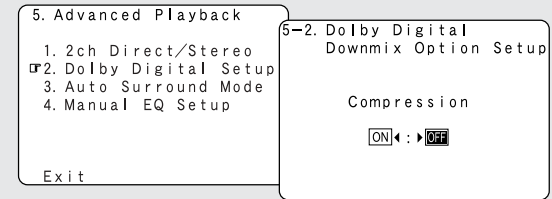

**2** Press the **CURSOR**  $\triangleleft$  or  $\triangleright$  button to select “ON” if you want to use the Compression, “OFF” if you do not want to use it.

**ON:**

The dynamic range is compressed automatically according to the combination of speakers being used.

**OFF:**

The dynamic range is not compressed.

- ※ Set “Compression” to “ON” if it seems that sound is distorted because the input level exceeds the allowable input for the front speakers.
- ※ When a center speaker or surround speakers are not connected, the sounds in those channels are directed to the front speakers.

**3** Press the **ENTER** button to enter the setting.

- The “Advanced Playback” menu reappears.

**Setting the Auto Surround Mode**

The surround mode used at last for the four types of input signals shown below is stored in the memory, and the signal is automatically played with that surround mode the next time it is input.

Note that the surround mode setting is also stored separately for the different input sources.

- ① Analog and PCM 2-channel signals (STEREO)
  - ② 2-channel signals of Dolby Digital, DTS or other multi-channel format (DOLBY PLIIx Cinema)
  - ③ Multi-channel signals of Dolby Digital, DTS or other multi-channel format (DOLBY/DTS SURROUND)
  - ④ PCM and DSD multi-channel signals other than Dolby Digital and DTS (MULTI CH IN)
- ※ Default settings are indicated in ( ).
- ※ During playback in the PURE DIRECT mode, the surround mode does not change even if the input signal is changed.

**1 Press the CURSOR  $\Delta$  or  $\nabla$  button to select “Auto Surround Mode” at the “Advanced Playback” menu, then press the ENTER button.**

• The “Auto Surround Mode” screen appears.

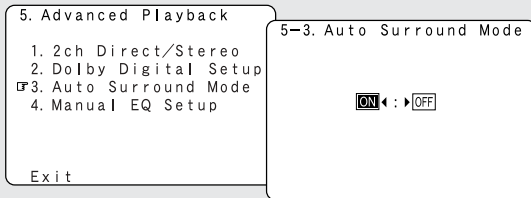

**2 Press the CURSOR  $\triangleleft$  or  $\triangleright$  button to select “ON” if you want to use the auto surround mode, “OFF” if you do not want to use it.**

**3 Press the ENTER button to enter the setting.**

• The “Advanced Playback” menu reappears.



• The various settings applied in the auto surround mode can be checked via the on screen display. Simply press the **ON SCREEN** button.

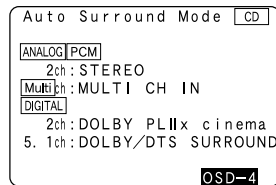

**Setting the Manual EQ Setup**

Allows you to adjust the tonal quality of the various speakers (except the subwoofer) while listening to a music source.

**1 Press the CURSOR  $\Delta$  or  $\nabla$  button to select “Manual EQ Setup” at the “Advanced Playback” menu, then press the ENTER button.**

• The “Manual EQ” screen appears.

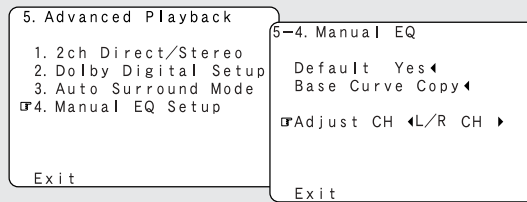

**2 Press the CURSOR  $\triangleleft$  or  $\triangleright$  button to select the adjustment mode, then press the ENTER button.**

**All CH:**

All channels can be adjusted simultaneously.

**L/R CH:**

The left and right channels of the pair of speakers can be adjusted simultaneously.

**Each CH:**

The channels can be adjusted separately.

**3 Press the CURSOR  $\triangleleft$  or  $\triangleright$  button to select the speaker to be set.**

• The screen switches to the character input screen.

**Example:** When “L/R CH” is selected.

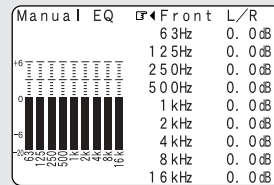

※ The display changes as follows.

① Select “L/R CH”

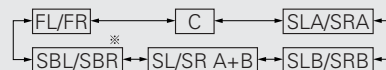

② Select “Each CH”

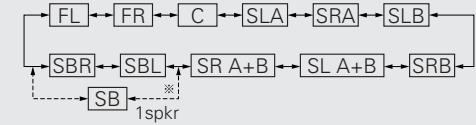

※ When the surround back speaker setting is set to “1spkr” at “Speaker Configuration”, this is set to “SB”.

③ Select “All CH”

In this case, speaker selection is not performed.

※ If a value is already set for the FL channel, the data stored for the FL channel is displayed.

**4 Press the CURSOR  $\Delta$  or  $\nabla$  button to select the frequency, then press the CURSOR  $\triangleleft$  or  $\triangleright$  button to adjust the gain level.**

※ Each frequency can be adjusted the range from -20 dB to +6 dB in 0.5 dB step.

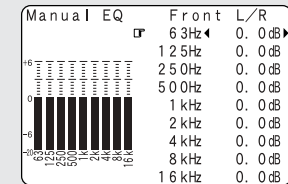

**5 Press the ENTER button to enter the setting.**

• The “Manual EQ” screen reappears.

**6 Press the CURSOR  $\Delta$  or  $\nabla$  button to select “Exit”, then press the ENTER button.**

• The “Advanced Playback” menu reappears.



• “Base Curve Copy” is displayed after performing the Auto Setup.

• To restore the settings to their defaults, select “Default Yes  $\triangleleft$ ”, then press the **CURSOR  $\triangleleft$**  button.

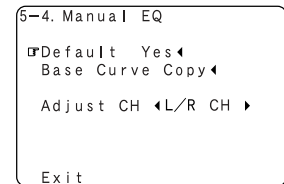



**Procedure for copying the “Flat” correction curve**

**1** Press the **CURSOR**  $\Delta$  button to select “Base Curve Copy”, then press the **CURSOR**  $\triangleleft$  button.

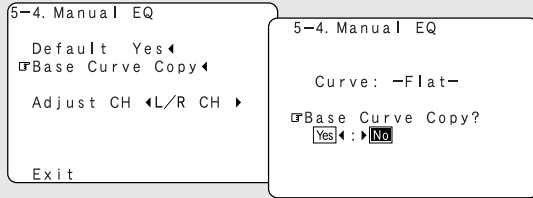

**2** Press the **CURSOR**  $\triangleleft$  button to select “Yes”.

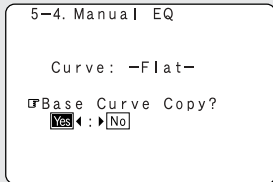

**3** Press the **ENTER** button to enter the setting.  
• The “Manual EQ” screen reappears.

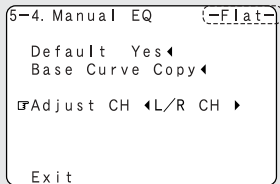

※ The type of the copied correction curve is displayed in the upper right of this screen.



• If the “Auto Setup” procedure has not been performed, this item is not displayed.

**Option Setup**

**Setting the Power Amplifier Assignment**

If no Surround back speakers are used in the main room, their amplifier channels can be assigned for multi-zone use or the front speaker’s bi-amp connection.

**1** Press the **CURSOR**  $\Delta$  or  $\nabla$  button to select “Option Setup” at the “System Setup Menu”, then press the **ENTER** button.

• The “Option Setup” screen appears.

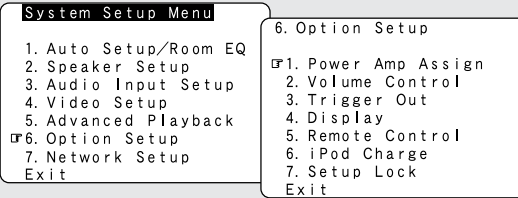

**2** Press the **CURSOR**  $\Delta$  or  $\nabla$  button to select “Power Amp Assign”, then press the **ENTER** button.

• The “Power Amp Assign” screen appears.

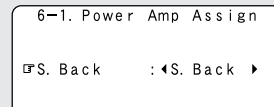

**3** Press the **CURSOR**  $\triangleleft$  or  $\triangleright$  button to select which channel to assign the surround back power amplifier to.

**S. Back:**

The Surround back speakers are used in MAIN ZONE.

**Front:**

This provides a bi-amp mode for the two main front speakers, replicating the front left and front right amplifier channel’s outputs.

**Front B:**

Both surround back power amplifier channels can be used to provide a second set of stereo outputs that match the front left and right speakers, providing a Front B option for stereo sound in another location (page 74).

**ZONE2:**

This mode assigns the surround back amplifier channels to provide ZONE2 speaker-level outputs from the surround back speaker terminals.

**ZONE3:**

This mode assigns the surround back amplifier channels to provide ZONE3 speaker-level outputs from the surround back speaker terminals.

**4** Press the **ENTER** button to enter the setting.  
• The “Option Setup” menu reappears.

**Front Bi-Amp connections**

Certain loudspeakers are equipped with two sets of input terminals, for bi-amplification. The AVR-4306 Amp Assign mode allows you to power bi-amp-capable speakers with two amplifier channels. Be sure to consult the owner’s manual of your bi-amp-capable speakers for further information before proceeding.

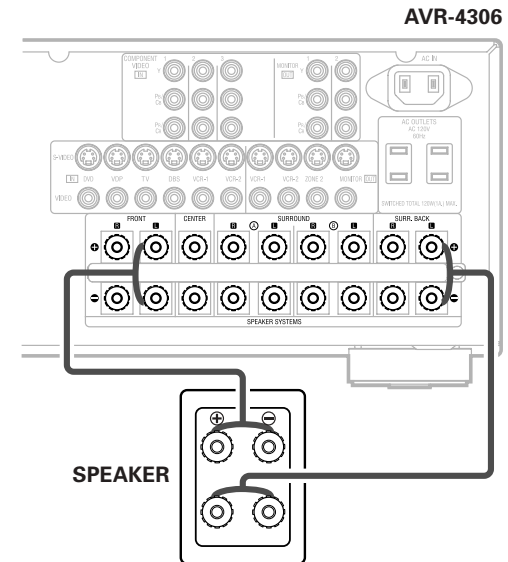

**NOTE:**

• When making bi-amp connections, be sure to remove the short-circuiting bar included with the speaker.

## Setting the Volume Control

Set the upper limit for the volume, the volume level when the power is turned on, and the volume level when the mute mode is set for the different zones.

### 1 Press the **CURSOR** $\Delta$ or $\nabla$ button to select “Volume Control” at the “Option Setup” menu, then press the **ENTER** button.

- The “Volume Control” screen appears.

```
6. Option Setup
1. Power Amp Assign
2. Volume Control
3. Trigger Out
4. Display
5. Remote Control
6. iPod Charge
7. Setup Lock
Exit
```

```
6-2. Volume Control
Main Vol. Limit OFF
P. On Lev. LAST
Mute Lev. FULL
Zone2 Vol. Lev. VAR
Vol. Limit OFF
P. On Lev. LAST
Mute Lev. FULL
6-2. Volume Control
Zone3 Vol. Lev. -VAR-
Vol. Limit OFF
P. On Lev. LAST
Mute Lev. FULL
```

### 2 Press the **CURSOR** $\Delta$ or $\nabla$ button to select the desired setting, then press the **CURSOR** $\triangleleft$ or $\triangleright$ button to select the parameter.

#### Volume Limit:

Set the upper limit for the volume for the different zones.

- **-20 dB, -10 dB, 0 dB:**

The volume cannot be increased above the selected levels.

- **OFF:**

If you do not want to set a volume limit, select “OFF”.

In this case, the volume can be set to the AVR-4306's maximum volume (output) level of +18 dB, which is extremely loud.

#### Power On Level:

Set the volume that is set when the power is turned on for the different zones.

You can adjust the MAIN ZONE volume level within the range of -80 dB to +18 dB and ZONE2 (or ZONE3) volume level within the range of -70 dB to +18 dB in steps of 1.0 dB.

- **--- (Mute)**

The volume is always muted when the power is turned on.

- **LAST**

The volume set when the AVR-4306 was last used is stored in the memory and set when the power is turned on.

#### Mute Level:

Set the volume attenuation level when the mute mode is set for the different zones.

- **FULL**

The volume is fully muted.

- **-40 dB**

The volume is lowered 40 dB from the current level.

- **-20 dB**

The volume is lowered 20 dB from the current level.

#### Volume Level:

Set whether to fix the output level for the different zones or make it variable.

- **Variable**

The level can be adjusted freely using buttons on the remote control unit.

- **-40 dB, 0 dB**

The output level is fixed at the set level and the volume can no longer be adjusted.

### 3 Press the **ENTER** button to enter the setting.

- The “Option Setup” menu reappears.



- For ZONE2 and ZONE3, the “Volume Limit” and “Power On Level” can be set when “Variable” is selected for “Volume Level”.

- When the power amplifier is assigned to either of the ZONE2 and ZONE3 channels at “Power Amp Assign”, “-VAR-” (only variable) is displayed and the fixed level cannot be set.

## Setting the Trigger Out

- Two 12 V DC Trigger Outputs on the rear panel can be used to control other devices with compatible trigger inputs, such as motorized screens, motorized screen masking, motorized drapes, and other trigger-controlled devices.
- Set the DC output supplied from the trigger out terminals for the various input sources to “ON” or “OFF”.

### 1 Press the **CURSOR** $\Delta$ or $\nabla$ button to select “Trigger Out” at the “Option Setup” menu, then press the **ENTER** button.

- The “Trigger Out” screen appears.

```
6. Option Setup
1. Power Amp Assign
2. Volume Control
3. Trigger Out
4. Display
5. Remote Control
6. iPod Charge
7. Setup Lock
Exit
6-3. Trigger Out
Trigger Out 1
Trigger Out 2
Default Yes
Exit
```

### 2 Press the **CURSOR** $\Delta$ or $\nabla$ button to select the trigger out terminal you want to set, then press the **ENTER** button.

- The setting screen appears.

**Example:** When “Trigger Out 1” is selected

```
6-3. Trigger Out 1
ZONE: MAIN
Tuner: OFF DBS: ON
Phono: OFF VCR-1: ON
CD: OFF VCR-2: ON
Tape: OFF V.Aux: ON
DVD: ON Aux 1:
VDP: ON Aux 2:
TV: ON Sur. Mode
```

- “Aux1” is setting of “AUX/Net”, and “Aux2” is setting of “AUX/iPod”.

### 3 Press the **CURSOR** $\triangleleft$ or $\triangleright$ button to select the zone (MAIN ZONE, ZONE2 and ZONE3).

- The power supplied from the trigger out terminal turns on and off when the power for the set zone is turned on and off.

**4** Press the **CURSOR**  $\Delta$  or  $\nabla$  button to select the input source, then press the **CURSOR**  $\triangleleft$  or  $\triangleright$  button to select “ON” or “OFF”.

**ON:**  
When that input source is selected, the power supplied from the trigger out terminal turns on.

**OFF:**  
When that input source is selected, the power supplied from the trigger out terminal turns off.

**5** When “MAIN” was selected at step 3: Press the **CURSOR**  $\Delta$  or  $\nabla$  button to select the surround mode, then press the **CURSOR**  $\triangleleft$  or  $\triangleright$  button to select “ON” or “OFF”.

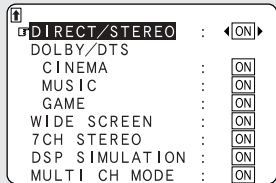

**ON:**  
If “ON” is selected when an input source set to “ON” is selected, the power supplied from the trigger out terminal turns on.

**OFF:**  
If “OFF” is selected when an input source set to “ON” is selected, the power supplied from the trigger out terminal turns off.

**6** Press the **ENTER** button.  
• The “Trigger Out” screen reappears.

※ Use the same procedure to make the settings for Trigger Out 2.

**7** Press the **CURSOR**  $\Delta$  or  $\nabla$  button to select “Exit”, then press the **ENTER** button.  
• The “Option Setup” menu reappears.

※ When “Yes” is selected for “Default”, the setting are automatically reset to the default values.

### Setting the Display

The brightness of the AVR-4306’s display can be adjusted in three steps.

**1** Press the **CURSOR**  $\Delta$  or  $\nabla$  button to select “Display” at the “Option Setup” menu, then press the **ENTER** button.  
• The “Display” screen appears.

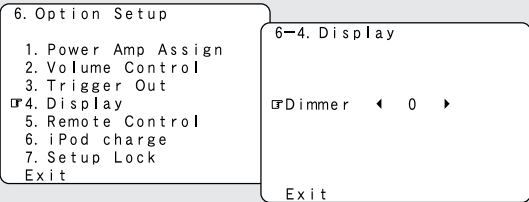

**2** Press the **CURSOR**  $\triangleleft$  or  $\triangleright$  button to select the brightness.

- 0: Normal (default setting)
- 1: Dim
- 2: Dark
- 3 (Display Off): Off

**3** Press the **ENTER** button to enter the setting.  
• The “Option Setup” menu reappears.

### Setting the Remote Control

Set this when you want to select the Network Audio, USB and iPod functions directly from multi zone with the remote control unit.

When this setting is made, the remote control unit’s DTU mode’s G1 to G8 normally used for Network Audio presetting are used, so they can no longer be used for Network Audio presetting.

**1** Press the **CURSOR**  $\Delta$  or  $\nabla$  button to select “Remote Control” at the “Option Setup” menu, then press the **ENTER** button.  
• The “Remote Control” screen appears.

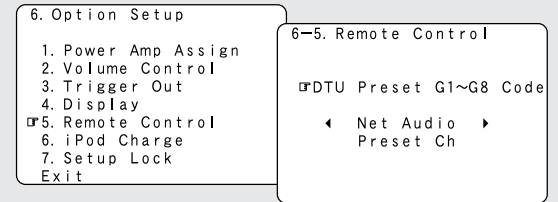

**2** Press the **CURSOR**  $\triangleleft$  or  $\triangleright$  button to select “Net Audio / USB / iPod Control”.



※ When “Net Audio/USB/iPod Control” is selected, DTU mode G1 to G8 cannot be used as Network Audio preset channels.

**3** Press the **ENTER** button to enter the setting.  
• The “Option Setup” menu reappears.

## ■ Operation on the remote control unit

**1** Press the **DTU** button to select the **DTU** mode.

**2** Press the **G** button, then press the corresponding **NUMBER** button (1 ~ 8) within five seconds.

- 1: Switch the ZONE2 input function to “iPod” and start playback.
- 2: Switch the ZONE3 input function to “iPod” and start playback.
- 3: iPod playback/pause
- 4: Switch the ZONE2 input function to “USB” and start playback.
- 5: Switch the ZONE3 input function to “USB” and start playback.
- 6: Network Audio playback/pause
- 7: Set the ZONE2 input function to “AUX/Net”.
- 8: Set the ZONE3 input function to “AUX/Net”.

※ When no music file is selected, playback starts from the first music file.

## Setting the iPod Charge

It is possible to charge your iPod while it is connected to the AVR-4306. You can even set the AVR-4306 to charge your iPod while the AVR-4306 is in the standby mode.

**1** Press the **CURSOR**  $\Delta$  or  $\nabla$  button to select “iPod Charge” at the “Option Setup” menu, then press the **ENTER** button.

- The “iPod Charge” screen appears.

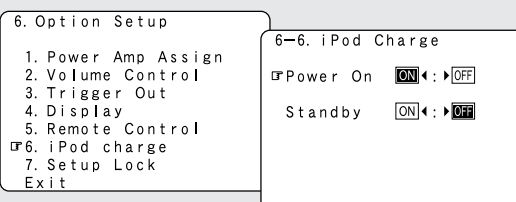

**2** Press the **CURSOR**  $\Delta$  or  $\nabla$  button to select the desired setting item, then press the **CURSOR**  $\triangleleft$  or  $\triangleright$  button to select “ON” or “OFF”.

### Power On:

Set whether or not to charge the iPod when it is connected with the AVR-4306’s power on.

- **ON** : The iPod is charged.
- **OFF** : The iPod is not charged.

### Standby:

Set whether or not to charge the iPod when it is connected with the AVR-4306’s power standby.

- **ON** : The iPod is charged.
- **OFF** : The iPod is not charged.

**3** Press the **ENTER** button to enter the setting.

- The “Option Setup” menu reappears.



- Depending on the connection status between the AVR-4306 and the iPod, the quality of the playback signals may be affected when playing audio or video signals during charging. If this happens, set the “iPod Charge” setting to “OFF”.

## Setup Lock

The system setup settings can be locked so that they cannot be changed easily.

**1** Press the **CURSOR**  $\Delta$  or  $\nabla$  button to select “Setup Lock” at the “Option Setup” menu, then press the **ENTER** button.

- The “Setup Lock” screen appears.

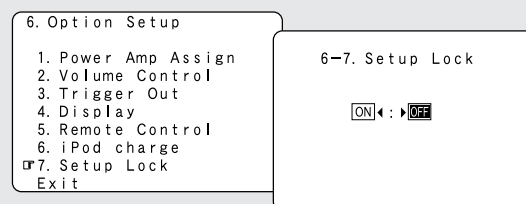

**2** Press the **CURSOR**  $\triangleleft$  button to select “ON”, to lock the system setup settings, then press the **ENTER** button.

- The “Option Setup” menu reappears.



- When the setup lock function is activated, the settings listed below cannot be changed, and “SETUP LOCKED!” is displayed when related buttons are operated.
  - System setup settings
  - Surround parameter settings
  - Tone control settings
  - Channel level settings (including test tones)
  - RoomEQ
- To unlock, press the **SYSTEM SETUP** button again and display the “Setup Lock” screen, then select “OFF” and press the **ENTER** button.

## Network Setup

If you are using a broadband router (DHCP function), there is no need to make the settings at “Network Setup”, since the DHCP function is set to “ON” in the AVR-4306’s default settings.

If the AVR-4306 is being used connected to a network without the DHCP function, the network settings must be made. In this case, some knowledge of networks is required.

### Setting the IP Address

Set this when “OFF” is set for “DHCP”.

Set the IP address within the ranges shown below. The Network Audio function cannot be used if other IP addresses are set.

- 1 Press the **CURSOR**  $\Delta$  or  $\nabla$  button to select “Network Setup” at the “System Setup Menu”, then press the **ENTER** button.

- The “Network Setup” screen appears.

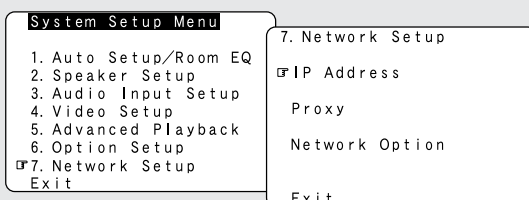

- 2 Press the **CURSOR**  $\Delta$  or  $\nabla$  button to select “IP Address”, then press the **ENTER** button.

- The “IP Address” screen appears.

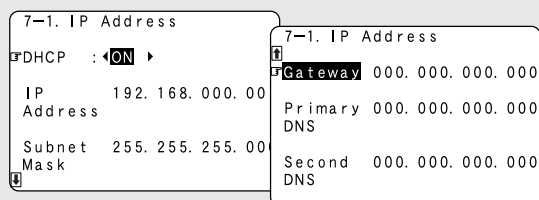

- 3 Press the **CURSOR**  $\triangleleft$  or  $\triangleright$  button to select “OFF”.

- The DHCP function is disabled.

- 4 Press the **CURSOR**  $\Delta$  or  $\nabla$  button to select the desired setting item, then press the **CURSOR**  $\triangleright$  button and **CURSOR**  $\Delta$  or  $\nabla$  button to input the address.

#### IP Address:

Set the IP address within the ranges shown below. The Network Audio function cannot be used if other IP addresses are set.

CLASS A: 10.0.0.0 ~ 10.255.255.255  
 CLASS B: 172.16.0.0 ~ 172.31.255.255  
 CLASS C: 192.168.0.0 ~ 192.168.255.255

#### Subnet Mask:

When connecting an xDSL modem or terminal adapter directly to the AVR-4306, input the subnet mask indicated in the documentation supplied by your provider. Normally input 255.255.255.0.

#### Gateway:

When connected to a gateway (router), input its IP address.

#### Primary DNS / Secondary DNS:

If there is only one DNS address indicated in the documentation supplied by your provider, input it at “e. 1st”. If there are two or more DNS addresses, input the first one at “f. 2nd”.

- 5 Press the **ENTER** button to enter the setting.

- The “IP Address” menu reappears.



- DHCP (Dynamic Host Configuration Protocol): These are systems by which the IP address and other network settings are automatically set for the AVR-4306, computer, broadband router and network devices.
- DNS (Domain Name System): This is a system for converting the domain names used when browsing Internet sites (for example, “www.jp”) into the IP addresses actually used for communications (for example, “202.221.192.106”).

## Setting the Proxy

Make this setting when connecting to the Internet via a proxy server.

- 1 Press the **CURSOR**  $\Delta$  or  $\nabla$  button to select “Proxy” at the “Network Setup” screen, then press the **ENTER** button.

- The “Proxy” screen appears.

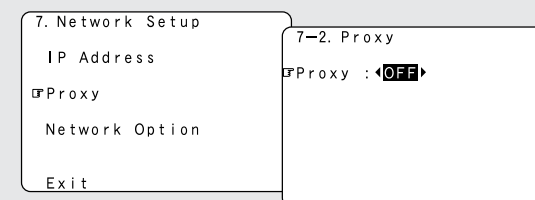

- 2 Press the **CURSOR**  $\triangleleft$  or  $\triangleright$  button to select “ON”.

- The proxy server is enabled.

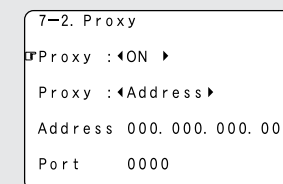

- 3 Press the **CURSOR**  $\Delta$  or  $\nabla$  button to select the desired setting item, then press the **CURSOR**  $\triangleright$  button and **CURSOR**  $\Delta$  or  $\nabla$  button to input the character or number.

#### Proxy:

Input the proxy server domain name or address.

#### Port:

Input the proxy server port number.

- 4 Press the **ENTER** button to enter the setting.

- The “Network Setup” menu reappears.

## Setting the Network Option

When not using the AVR-4306 connected in a network, set “ON” to reduce the power consumption when in the standby mode.

### Setting the Power Saving

**1** Press the **CURSOR**  $\triangle$  or  $\nabla$  button to select “Network Option” at the “Network Setup” screen, then press the **ENTER** button.

- The “Network Option” screen appears.

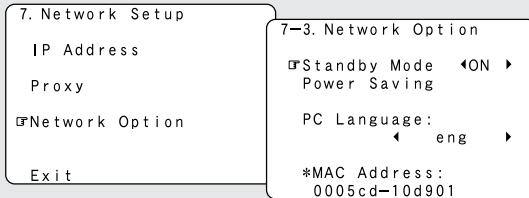

**2** Press the **CURSOR**  $\triangleleft$  or  $\triangleright$  button to select “OFF”.

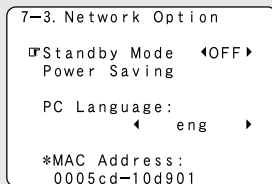

※ Set “OFF” when using the AVR-4306 connected in a network.

**3** Press the **ENTER** button to enter the setting.

- The “Network Setup” menu reappears.

### Setting the PC Language

Select according to the language of the computer being used. The languages are indicated with three letters conforming to ISO639-2.

**1** Press the **CURSOR**  $\triangleleft$  or  $\triangleright$  button to select the PC language.

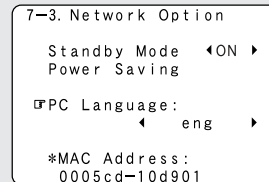

**2** Press the **ENTER** button to enter the setting.

- The “Network Setup” menu reappears.

### Setting the MAC Address

The AVR-4306’s MAC address is displayed. The MAC address differs for each set.

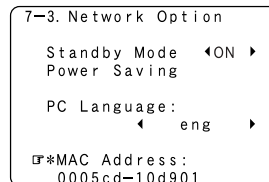

# Advanced Setup – Part 2

This Speaker Setup section describes the procedures to make speaker settings manually (without using the Auto Setup function), as well as to make manual changes to settings that have already been made by the Auto Setup function.

## Speaker Setup

- If the "Auto Setup" procedure has already been performed, there is no need to make this setting.
- Perform this setting if you wish to make the settings for your speaker systems manually.

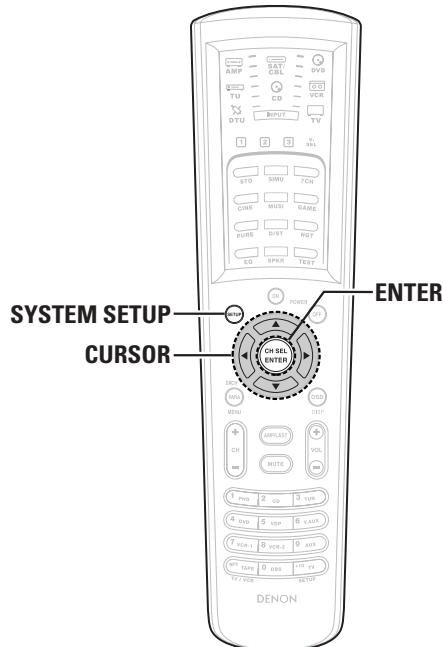
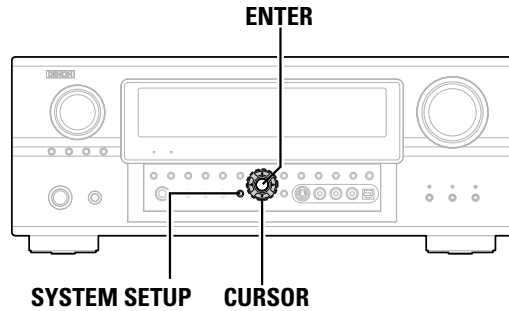

### Setting the type of speakers

The composition of the signals output to each channels and the frequency response are adjusted according to the combination of speakers actually being used.

**1** Press the **CURSOR**  $\Delta$  or  $\nabla$  button to select "Speaker Setup" at the "System Setup Menu", then press the **ENTER** button.

- The "Speaker Setup" menu screen appears.

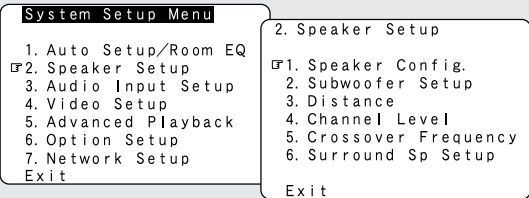

**2** Press the **CURSOR**  $\Delta$  or  $\nabla$  button to select "Speaker Config.," then press the **ENTER** button.

- The "Speaker Config." screen appears.

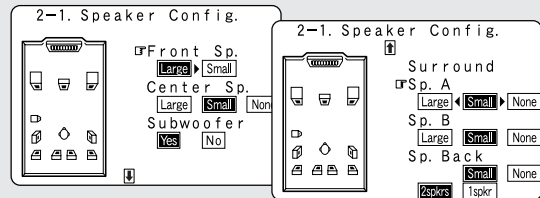

**3** Press the **CURSOR**  $\Delta$  or  $\nabla$  button to select the speaker, then press the **CURSOR**  $\triangleleft$  or  $\triangleright$  button to select the parameter.

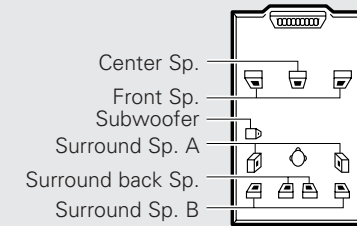

**4** Press the **ENTER** button to enter the setting.

- The "Speaker Setup" menu reappears.



- Select "Large" or "Small" not according to the actual size of the speaker but according to the speaker's capacity for playing low frequency (bass sound below the frequency set for the Crossover Frequency) signals. If you do not know, try comparing the sound at both settings (setting the volume to a level low enough so as not to damage the speakers) to determine the proper setting.

### Parameters

#### Large:

Select this when using speakers that can fully reproduce deep bass well below the frequency set for the Crossover Frequency mode.

#### Small:

Select this when using speakers that are not capable of handling deep bass well below the frequency set for the Crossover Frequency mode. Deep bass content in any channel with a SMALL speaker is routed to the subwoofer(s).

#### None:

Select this when no speakers are installed.

#### Yes / No:

Select "Yes" when a subwoofer is installed, "No" when a subwoofer is not installed.

#### 2spkr / 1spkr:

Select the number of speakers to be used for the surround back channel.

Advanced Setup – Part 2

- \* A subwoofer with sufficient low frequency playback capability can better handle deep bass than most main and surround speakers, and the system's overall performance will be greatly enhanced when SMALL is set for the main (front) and surround speakers.
- \* When "Front" is set to "Small", "Subwoofer" is automatically set to "Yes", and when "Subwoofer" is set to "No", "Front" is automatically set to "Large".

**Setting the low frequency distribution**

- Set the subwoofer mode according to the speaker system being used.
- Select the play mode that provides bass reproduction with body.

**1** Press the **CURSOR**  $\Delta$  or  $\nabla$  button to select "Subwoofer Setup" at the "Speaker Setup" menu, then press the **ENTER** button.

- The "Subwoofer Setup" screen appears.

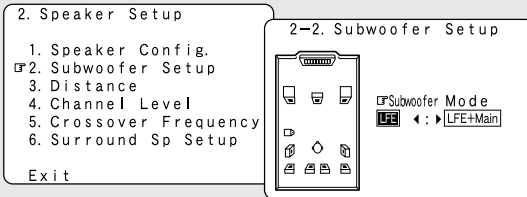

**2** Press the **CURSOR**  $\triangleleft$  or  $\triangleright$  button to select the setting.

**LFE:**

For any channel(s) that are set to LARGE, low frequencies in that channel's corresponding source are directed to that loudspeaker only. Low frequencies that are directed to the subwoofer(s) are from the program source LFE channel, and from other channels where the speakers are set to SMALL.

**LFE+Main:**

Low frequencies from speaker channels that have been set to LARGE are reproduced from those speakers as well as from the subwoofer(s). Depending upon the characteristics of the LARGE main speakers, this mode may provide a more even low frequency response throughout the listening room.

**3** Press the **ENTER** button to enter the setting.

- The "Speaker Setup" menu reappears.



**Assignment of low frequency signal range**

- The only signals produced from the subwoofer channel are LFE signals (during playback of Dolby Digital or DTS signals) and the low frequency signal range of channels set to "Small" in the setup menu. The low frequency signal range of channels set to "Large" are produced from those channels.

**Subwoofer Setup**

- The subwoofer mode setting is only valid when and "Yes" is set for the subwoofer in the "Speaker Configuration" settings (page 82).
- When the input signal is analog or a PCM signal not including LFE signals, if "LFE" is selected, the low frequency component is not output from the subwoofer. To output the subwoofer channel, select "LFE+Main".

**Setting the Distance**

Input the distance between the listening position and the different speakers to set the delay time for the surround mode.

**Preparations:**

Measure the distances between the listening position and the speakers (L1 to L10 on the diagram at the below).

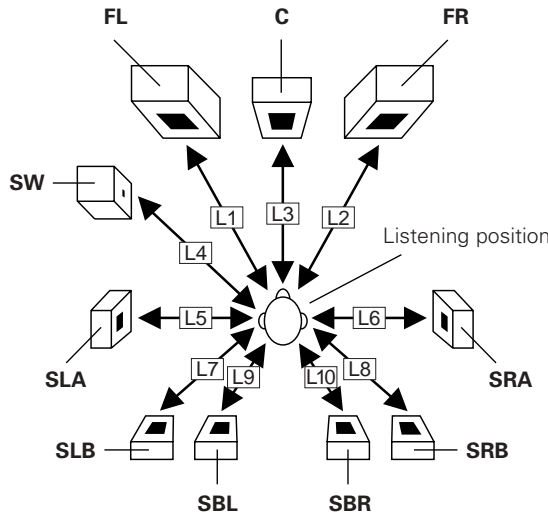

**1** Press the **CURSOR**  $\Delta$  or  $\nabla$  button to select "Distance" at the "Speaker Setup" menu, then press the **ENTER** button.

- The "Distance" screen appears.

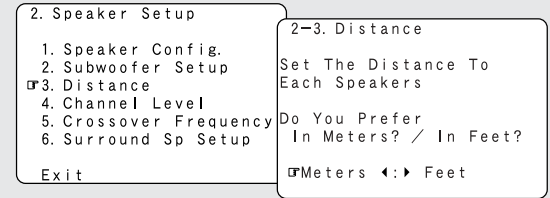

**2** Press the **CURSOR**  $\triangleleft$  or  $\triangleright$  button to select the desired unit, "Meters" or "Feet".

- The "Distance" screen appears automatically.

**Example:** When "Feet" is selected

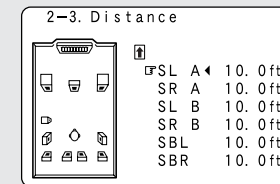
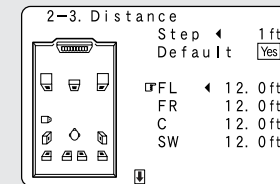
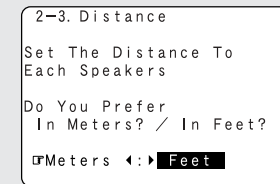

**3** Press the **CURSOR**  $\Delta$  or  $\nabla$  button to select the speaker to be set.



#### 4 Press the **CURSOR** ◀ or ▶ button to set the distance between the center speaker and listening position.

**Example:** When the distance is set to 10 feet for the center speaker

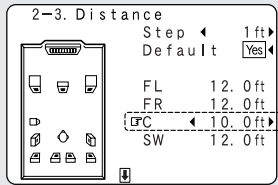

- ※ The distance changes in units of 1 foot (0.1 meters) or 0.1 foot (0.01 meters) each time the button is pressed. Select the value closest to the measured distance.
- ※ When "Step" is selected, you can select the unit of "1 ft (0.1 m)" or "0.1 ft (0.01 m)".
- ※ When "Yes" is selected for "Default", the settings are automatically reset to the default values.
- ※ **Please note that the difference of distance for every speaker should be 20 ft (6.0 m) or less. If you set an invalid distance, a CAUTION notice, such as screen right will appear. In this case, please relocate the blinking speaker(s) so that its distance is no larger than the value shown in highlighted line.**

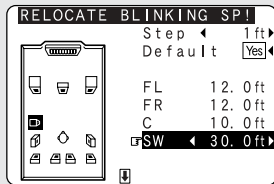

#### 5 Press the **ENTER** button to enter the setting.

- The "Speaker Setup" menu reappears.

- ※ The AVR-4306 automatically sets the optimum surround delay time for the listening room.

### Setting the Channel Level

- Use this setting to adjust so that the playback level between the different channels is equal.
- From the listening position, listen to the test tones produced from the speakers to adjust the level.

#### 1 Press the **CURSOR** ▲ or ▼ button to select "Channel Level" at the "Speaker Setup" menu, then press the **ENTER** button.

- The "Channel Level" screen appears.

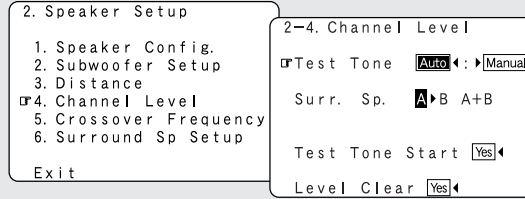

#### 2 Press the **CURSOR** ◀ or ▶ button to select "Auto" or "Manual".

##### Auto:

Adjust the level while listening to the test tones produced automatically from each speaker.  
Test tones are automatically emitted from each speaker.

##### Manual:

Select the speaker from which you want to produce the test tone to adjust the level.

**Example:** When the "Auto" mode is selected

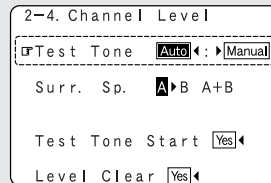

#### 3 Press the **CURSOR** ▲ or ▼ button to select "Surr. Sp.", then press the **CURSOR** ◀ or ▶ button to select the surround speaker(s) from which you want to produce the test tone (A, B or A+B).

##### Surr. Sp. : A

Adjusts the balance of the playback level between the channels when using surround speaker A.

##### Surr. Sp. : B

Adjusts the balance of the playback level between the channels when using surround speaker B.

##### Surr. Sp. : A + B

Adjusts the balance of the playback level between the channels when using surround speakers A and B at the same time.

- ※ The "Surr. Sp." can only be selected when both surround speakers A and B have been selected at the System Setup Menu (when both A and B have been set to "Large" or "Small").

#### 4 Press the **CURSOR** ▲ or ▼ button to select "Test Tone Start", then press the **CURSOR** ◀ button to select "Yes".

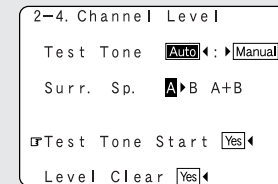

#### 5 When "Auto" mode is selected: Press the **CURSOR** ◀ or ▶ button to adjust all -1 the speakers to the same volume.

- The test tones are emitted from each speaker in the following order, at 4-second intervals during the first and second time, and at the 2-second intervals during the third and subsequent cycles:

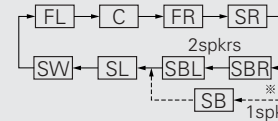

- ※ When the surround back speaker setting is set to "1spkr" for "Speaker Configuration", this is set to "SB".

**Example:** When the volume is set to -11.5 dB while the test tone is being produced from the Front Lch speaker

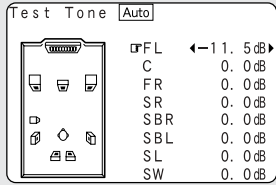

※ The volume can be adjusted between -12 dB and +12 dB in units of 0.5 dB.

**5** When “Manual” mode is selected:  
 Press the **CURSOR**  $\Delta$  or  $\nabla$  button to select the speaker, then press the **CURSOR**  $\triangleleft$  or  $\triangleright$  button to adjust all the speakers to the same volume.

**Example:** “Manual” mode is selected.

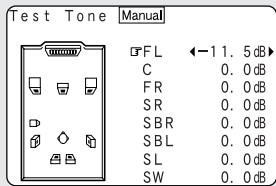

**6** Press the **ENTER** button to enter the setting.  
 • The “Channel Level” screen reappears.



• To cancel the settings, press the **CURSOR**  $\triangleleft$  button to select “Level Clear” and “Yes” on the “Channel Level” screen, then make the settings again.

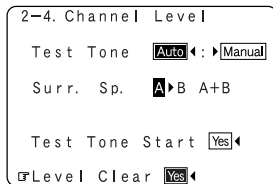

- When adjusting the level of an active subwoofer system, you may also need to adjust the subwoofer’s own volume control.
- When you adjust the channel levels while in the system setup channel level mode, the channel level adjustments mode will affect all surround modes. Consider this mode a master channel level adjustment mode.
- After you have completed the system setup channel level adjustments, you can then activate the individual surround modes and adjust channel levels that will be remembered for each of those modes. Then, whenever you activate a particular surround sound mode, your preferred channel level adjustments for just that mode will be recalled. Check the instructions for adjusting channel levels within each surround mode (page 39).
- You can adjust the channel levels for each of the following surround modes: PURE DIRECT/DIRECT, STEREO, DOLBY/DTS SURROUND, 7CH STEREO, WIDE SCREEN, SUPER STADIUM, ROCK ARENA, JAZZ CLUB, CLASSIC CONCERT, MONO MOVIE, VIDEO GAME, MATRIX and VIRTUAL.
- When using either surround speakers A or B, or when using surround speakers A and B at the same time, be sure to adjust the balance of playback levels between each channel for the various selections of “A”, “B” and “A + B”.

### ■ Adjusting the test tone using the remote control unit

- As described below, this adjustment can be accomplished via the with remote control unit.
- Adjusting with the remote control unit using the test tones is only possible in the “Auto” mode and only effective in the STANDARD (DOLBY/DTS SURROUND) mode. The adjusted levels for the different modes are automatically stored in the memory.

**1** Press the **TEST TONE** button.  
 • Test tones are output from the different speakers.

**2** Press the **CURSOR**  $\triangleleft$  or  $\triangleright$  button to adjust the channel level so that the volume of the test tones is the same for all the speakers.

**3** After completing the adjustment, press the **TEST TONE** button again.

### Setting the Crossover Frequency

- Set the crossover frequency according to the low frequency response characteristics of the various (front, center, surround and surround back) speaker systems.
- If a connected main or surround loudspeaker has a specified -3 dB low frequency response rolloff, adjust the crossover frequency for that speaker to match the specified low frequency response limit – e.g. 80 Hz.
- When a speaker is set to “SMALL”, low frequencies in that channel that are below the crossover frequency are directed to the system’s subwoofer(s), or to speakers that are set to “LARGE”, for systems with no connected subwoofer(s).

**1** Press the **CURSOR**  $\Delta$  or  $\nabla$  button to select “Crossover Frequency” at the “Speaker Setup” menu, then press the **ENTER** button.

- The “Crossover Frequency” screen appears.

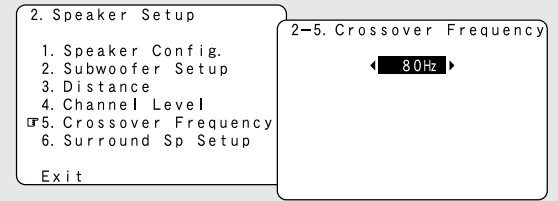

**2** Press the **CURSOR**  $\triangleleft$  or  $\triangleright$  button to select the frequency.

**40, 60, 80, 90, 100, 110, 120, 150, 200, 250 Hz:**

Set as desired according to your speakers’ bass playback ability.

#### Advanced:

The crossover frequency can be set individually for the different speakers.

**3** Press the **ENTER** button to enter the setting.  
 • The “Speaker Setup” menu reappears.



- If “LFE+Main” is set at “Subwoofer Setup”, “SW:LFE+Main” (page 83) is displayed at the top right of the screen.

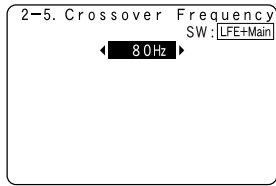

- We recommend using with the crossover frequency set to “80Hz”, but depending on the speaker, setting it to a different frequency may improve frequency response near the crossover frequency.
- The crossover frequency mode is valid only when subwoofer is set to “ON”, and when one or more speakers are set to “SMALL”, as described in section “Speaker Configuration” settings (page 82).

### Setting the crossover frequency individually for the different channels

**1** Press the **CURSOR** ◀ or ▶ button to select “Advanced” at the “Crossover Frequency” screen.

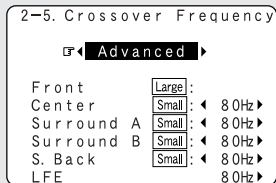

**2** Press the **CURSOR** ▲ or ▼ button to select the speaker to be set.

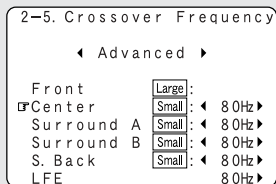

**3** Press the **CURSOR** ◀ or ▶ button to select the frequency.

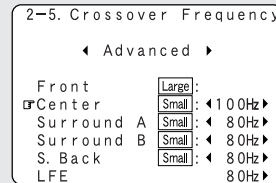

**4** Press the **ENTER** button to enter the setting.

- The “Speaker Setup” menu reappears.



- If “LFE” is selected at “Subwoofer Setup”, the frequencies can only be selected for speakers set to “Small” at “Speaker Configuration”.

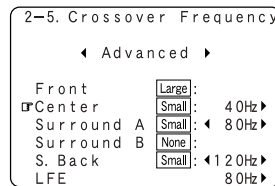

- If “LFE+Main” is set at “Subwoofer Setup”, the frequencies can be selected regardless of the speaker size setting.

### Selecting the Surround Speakers for the different surround modes

- This menu is displayed when both surround speakers A and B are used.
- At this screen preset the surround speakers to be used in each surround modes.

**1** Press the **CURSOR** ▲ or ▼ button to select “Surround Sp Setup” at the “Speaker Setup” menu, then press the **ENTER** button.

- The “Surround Sp Setup” screen appears.

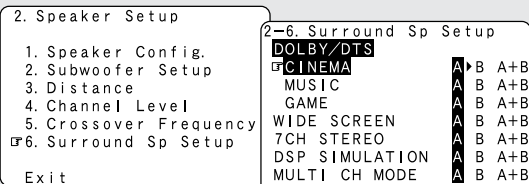

**2** Press the **CURSOR** ▲ or ▼ button to select the surround mode, then press the **CURSOR** ◀ or ▶ button to select the surround speaker.

**A:**  
When surround speakers A is used.

**B:**  
When surround speakers B is used.

**A + B:**  
When both surround speakers A and B are used.

**3** Press the **ENTER** button to enter the setting.

- The “Speaker Setup” menu reappears.



- For the “WIDE SCREEN” and “7CH STEREO” DSP simulation modes, the surround speakers can be set separately.

### About Speaker type setting when using both surround speakers A and B

- If “Small” is set for either surround speakers A or B, the output is the same as when “Small” is set for both A and B.

Others Setup

Setting the Room EQ Setup

Select the setting of an Equalizer that has been set with Auto Setup or Manual EQ.

**1** Press the **CURSOR**  $\Delta$  or  $\nabla$  button to select “Room EQ Setup” at the “Auto Setup / Room EQ” menu, then press the **ENTER** button.

- The “Room EQ Setup” screen appears.

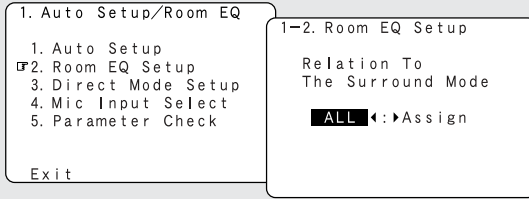

**2** Press the **CURSOR**  $\triangleleft$  or  $\triangleright$  button to select “All” or “Assign”.

**All:**  
Sets the Equalizer for all surround modes.

**Assign:**  
Sets the Equalizer individually for each surround mode.

**3** When “All” is selected:

**1** Press the **ENTER** button.

- The “Room EQ” screen appears.

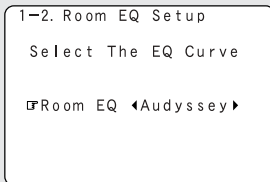

**2** Press the **CURSOR**  $\triangleleft$  or  $\triangleright$  button to select the equalizer setting.

**OFF:**  
The Equalizer is not used.

**Audyssey:**  
Adjusts the frequency response of all speakers to correct the effects of room acoustics.

**Front:**  
Adjusts the frequency response of the surround speakers to match the characteristics of the front channel speakers.

**Flat:**  
Adjusts the frequency response of all speakers to the flattest response. This mode is suitable for multi-channel music surround sound sources.

**Manual:**  
Selects the setting value that was set in the Manual EQ Setup.  
For details of the “Manual EQ Setup” (page 75, 76).

**3** When “Assign” is selected:  
**After completing system setup, select the desired equalizer setting pressing the ROOM EQ button.**

- Equalizer settings for the individual surround modes can be stored in the memory.
- ※ Whenever the **ROOM EQ** button is pressed, the display switches as shown below.

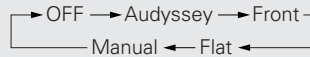

**4** Press the **ENTER** button to enter the setting.  
• The “Auto Setup / Room EQ” menu reappears.



- The Equalizer setting of “Audyssey”, “Front” and “Flat” can be selected after performing the Auto Setup.
- When the speaker set as “None” with the Auto Setup is changed to on manually, the equalizer of “Audyssey”, “Front” and “Flat” cannot be used.
- The Equalizer setting can be selected directly by **ROOM EQ** button.
- When headphones are connected, the Room EQ cannot be used.

Setting the Direct Mode Setup

Perform the ON/OFF setting of Room EQ when the surround mode is “DIRECT” or “PURE DIRECT”.

**1** Press the **CURSOR**  $\Delta$  or  $\nabla$  button to select “Direct Mode Setup” at the “Auto Setup / Room EQ” menu, then press the **ENTER** button.

- The “Direct Mode Setup” screen appears.

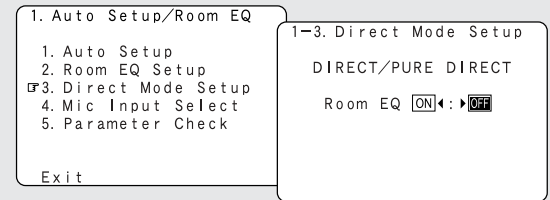

**2** Press the **CURSOR**  $\triangleleft$  or  $\triangleright$  button to select “ON” or “OFF”.

**3** Press the **ENTER** button to enter the setting.  
• The “Auto Setup / Room EQ” menu reappears.

Setting the MIC Input Select

Sets whether the setup microphone is connected to the PIN JACK (V.AUX L channel) connector or the MINI JACK (SETUP MIC) connector.

**1** Press the **CURSOR**  $\Delta$  or  $\nabla$  button to select “Mic Input Select” at the “Auto Setup / Room EQ” menu, then press the **ENTER** button.

- The “Mic Input Select” screen appears.

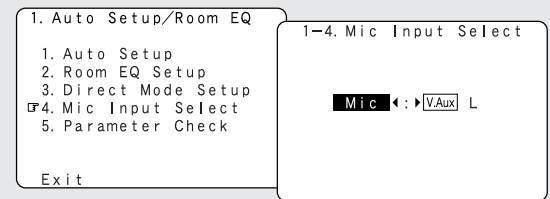

**2** Press the **CURSOR**  $\triangleleft$  or  $\triangleright$  button to select “Mic” or “V.Aux L”.

**3** Press the **ENTER** button to enter the setting.  
• The “Auto Setup / Room EQ” menu reappears.

**Check the parameter**

- The results of the measured items can be checked.
- The EQ parameters that were set in Auto Setup can be checked.
- This item is displayed, after the measurement result of the “Auto Setup / Room EQ” is decided.

**1** Press the **CURSOR**  $\Delta$  or  $\nabla$  button to select “Parameter Check” at the “Auto Setup / Room EQ” menu, then press the **ENTER** button.

- The “Parameter Check” screen appears.

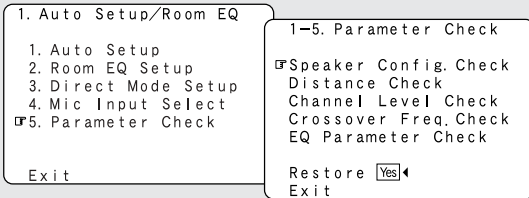

**2** Press the **CURSOR**  $\Delta$  or  $\nabla$  button to select the items, then press the **ENTER** button.

- The verification screen appears.

※ For instructions on checking the results of each item (page 12, 13).

**3** Press the **CURSOR**  $\Delta$  or  $\nabla$  button to select “EQ Parameter Check”, then press the **ENTER** button.

- The “EQ Parameter Check” screen appears.

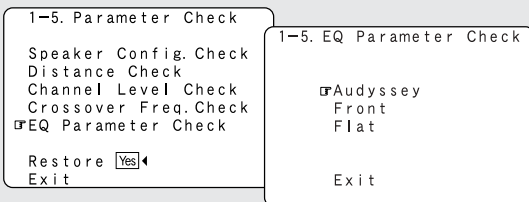

**4** Press the **CURSOR**  $\Delta$  or  $\nabla$  button to select the Equalizer curve, then press the **ENTER** button.

- The “EQ Check” screen appears.

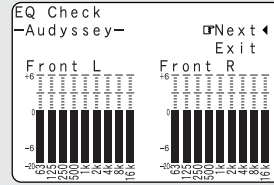

※ The display is only an approximate picture of the response and that correction is happening at all frequencies.

**5** Press the **CURSOR**  $\triangleleft$  or  $\triangleright$  button to select the speaker channel.

**6** If the check ends, pressing the **CURSOR**  $\Delta$  or  $\nabla$  button to select “Exit”, then press the **ENTER** button.

- The “EQ Parameter Check” screen reappears.

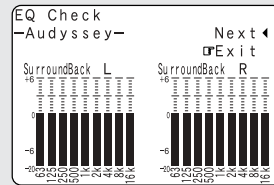

**7** Press the **CURSOR**  $\Delta$  or  $\nabla$  button to select “Exit”, then press the **ENTER** button.

- The “Parameter Check” screen reappears.

**8** The results of the “Auto Setup” procedure can be reset even if the settings have been changed after performing the “Auto Setup” procedure: Press the **CURSOR**  $\Delta$  or  $\nabla$  button to select “Restore Yes  $\triangleleft$ ”, then press the **CURSOR**  $\triangleleft$  button.

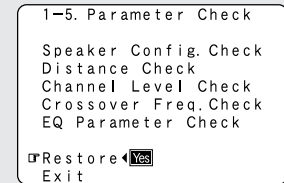

**9** Press the **CURSOR**  $\Delta$  or  $\nabla$  button to select “Exit”, then press the **ENTER** button.

- The “Auto Setup / Room EQ” menu reappears.

## System setup items and default values (set upon shipment from the factory)

### 1. Auto Setup/Room EQ

Auto Setup / Room EQ		Default settings	Page	
1	<b>Auto Setup</b>	This unit performs an analysis of the speaker system and measures the acoustic characteristics of your room to permit an appropriate automatic setting.	–	9–13
2	<b>Room EQ Setup</b>	Set the Room EQ setting with All or Assign for each surround mode.	All, Room EQ = OFF	87
3	<b>Direct Mode Setup</b>	Set the ON/OFF setting of Room EQ, in the case of the surround mode is in "Direct" or "Pure Direct".	OFF	87
4	<b>Mic Input Select</b>	Set this to switch the Mic Input jack for use for Mic or V.AUX L-channel input terminal.	Mic	87

### 2. Speaker Setup

Speaker Setup		Default settings							Page		
1	<b>Speaker Configuration</b>	Input the combination of speakers in your system and their corresponding sizes (SMALL for regular speakers, LARGE for full-size, full-range) to automatically set the composition of the signals output from the speakers and the frequency response.	Front Sp.		Center Sp.	Subwoofer	Surround Sp. A / B	Surround Back Sp.	82		
			Large	Small	Yes	Small	Small / 2spkrs				
2	<b>Subwoofer Setup</b>	This selects the subwoofer for playing deep bass signals.	LFE						83		
3	<b>Distance</b>	This parameter is for optimizing the timing with which the audio signals are produced from the speakers and subwoofer according to the listening position.	Front L & R	Center	Subwoofer	Surround L & R (A)	Surround L & R (B)	Surround Back	83, 84		
			12 ft (3.6 m)	12 ft (3.6 m)	12 ft (3.6 m)	10 ft (3.0 m)	10 ft (3.0 m)	10 ft (3.0 m)			
4	<b>Channel Level</b>	This adjusts the volume of the signals output from the speakers and subwoofer for the different channels in order to obtain optimum effects.	Front L	Front R	Center	Surround L	Surround R	Surround Back L	Surround Back R	Subwoofer	84, 85
			0 dB	0 dB	0 dB	0 dB	0 dB	0 dB	0 dB	0 dB	
5	<b>Crossover Frequency</b>	Set the frequency (Hz) below which the bass sound of the various speakers is to be output from the subwoofer.	80 Hz						85, 86		
6	<b>Surround Speaker Setup</b>	Use this function when using multiple surround speaker combinations for more ideal surround sound. Once the combinations of surround speakers to be used for the different surround modes are preset, the surround speakers are selected automatically according to the surround mode.	<b>Surround mode</b>	DOLBY/DTS CINEMA	DOLBY/DTS MUSIC	DOLBY GAME	WIDE SCREEN	7 CH STEREO	DSP SIMULATION	MULTI CH MODE	86
			<b>Surround speaker</b>	A	A	A	A	A	A	A	

3. Audio Input Setup

Audio Input Setup				Default settings										Page		
1	Digital In Assign	This assigns the digital input terminals for the different input sources.	Input source	CD	DVD	VDP	TV	DBS	VCR-1	VCR-2	CDR / TAPE	V.AUX	67			
			Digital Inputs	COAX 1	COAX 2	OPT 1	OFF	OPT 2	OPT 3	OFF	OPT 4	OPT 5				
2	EXT.IN Setup	Set the Ext.In terminals playback method.	Surr.Sp = Surr.A SW Level = +15dB										67, 68			
3	iPod Assign	When connecting the iPod via a iPod Dock, it is possible to assign the iPod Dock's audio and video signals to any input connectors on the AVR-4306 and play them.	iPod Function = Aux iPod Dock = NotUsed										68			
4	Input Function Lev.	The playback level is corrected individually for the different input sources.	TUNER	PHONO	CD	CDR / TAPE	DVD	VDP	TV	DBS	VCR-1	VCR-2	V.AUX	AUX1	AUX2	68
			0 dB	0 dB	0 dB	0 dB	0 dB	0 dB	0 dB	0 dB	0 dB	0 dB	0 dB	0 dB	0 dB	
5	Function Rename	The names of the different input source can be changed as desired and displayed on the display.	TUNER	PHONO	CD	CDR / TAPE	DVD	VDP	TV	DBS	VCR-1	VCR-2	V.AUX	AUX1	AUX2	69
6	Tuner Presets	Auto Preset Memory FM stations are received automatically and stored in the memory.	A1 ~ A8	87.5/89.1/98.1/107.9/90.1/90.1/90.1 MHz												69, 70
			B1 ~ B8	520/600/1000/1400/1500/1710 kHz, 90.1/90.1 MHz												
			C1 ~ C8	90.1 MHz												
			D1 ~ D8	90.1 MHz												
			E1 ~ E8	90.1 MHz												
			F1 ~ F8	90.1 MHz												
			G1 ~ G8	90.1 MHz												
	Preset Skip	Preset channels that are not used often can be skipped.	All preset channels = ON													
	Preset Name	The preset channels can be given the names you want.	-													

4. Video Setup

Video Setup			Default settings						Page	
1	HDMI In Assign	The HDMI input terminals are assigned for the different input sources. Select the HDMI audio signal playback method.	DVD	VDP	TV	DBS	VCR-1	VCR-2	V.AUX	71
			NONE	NONE	NONE	NONE	NONE	NONE	NONE	
2	Component In Assign	This assigns the component video input terminals for the different input sources.	DVD	VDP	TV	DBS	VCR-1	VCR-2	V.AUX	71, 72
			1-RCA	NONE	2-RCA	3-RCA	NONE	NONE	NONE	
3	Video Convert	This sets whether or not to use the video conversion function.	ON						72	
4	HDMI Out Setup	This sets whether or not to use the function for converting analog video (composite video, S-Video or component video) signals into HDMI signals. When using this conversion function, set the aspect ratio, set the resolution, set the color format and video range of the signals output from the HDMI terminal.	Convert = ON Aspect = Full Resolution = 480p/576p Color Space = Y Cb Cr RGB Mode = Normal						72, 73	
5	Audio Delay	Set the audio delay timing to synchronize the sound and video.	0 ms						73	
6	On Screen Display	This sets whether or not to display the on screen display that appears on the monitor screen when the controls on the remote control unit or main unit are operated.	Function/Mode = ON Master Volume = ON Mode = Mode 1						73	

5. Advanced Playback

Advanced Playback		Default settings	Page
1	<b>2ch Direct/Stereo</b> The speaker settings can be changed specifically for playing in the 2-channel direct or stereo mode.	Basic	74
2	<b>Dolby Digital Setup</b> Turn the audio compression on or off when down-mixing Dolby Digital signals.	OFF	74
3	<b>Auto Surround Mode</b> Set the Auto surround mode function.	Auto Surround Mode = ON	75
4	<b>Manual EQ Setup</b> This parameter is for optimizing the Room EQ with which the audio signals are produced from the speakers.	All Channels and Frequency = 0 dB	75, 76

6. Option Setup

Option Setup		Default settings	Page													
1	<b>Power Amp Assign</b> To suit your preference, a surround back channel's power amplifier can be assigned to the front channel for bi-amp playback, ZONE2 or ZONE3.	S. Back	76													
2	<b>Volume Control</b> This sets the volume level of each zone output. <b>Volume Limit:</b> This sets the upper limit for the master volume. <b>Power On Level:</b> This sets the volume level upon switching on the power of each zone. <b>Mute Level:</b> This sets the amount of attenuation of the audio output when each zone is muted. <b>Volume Level:</b> This sets whether the output level of ZONE2 is fixed or variable.	<b>Main</b> Vol.Limit = OFF P. On Lev. = LAST Mute Lev. = FULL	77													
		<b>Zone2</b> Vol.Lev. = VAR Vol.Limit = OFF P. On Lev. = LAST Mute Lev. = FULL														
		<b>Zone3</b> Vol.Lev. = VAR Vol.Limit = OFF P. On Lev. = LAST Mute Lev. = FULL														
3	<b>Trigger Out Setup</b> This sets the Trigger Out output for the different input sources. If "ZONE = MAIN" is selected, settings can be made for the individual surround modes.	ZONE = MAIN, All Surround Modes = ON												77, 78		
		<b>Trigger Out 1</b>	TUNER	PHONO	CD	CDR / TAPE	DVD	VDP	TV	DBS	VCR-1	VCR-2	V.AUX		AUX1	AUX2
			OFF	OFF	OFF	OFF	ON	ON	ON	ON	ON	ON	ON		ON	ON
		<b>Trigger Out 2</b>	ZONE = 2													
		TUNER	PHONO	CD	CDR / TAPE	DVD	VDP	TV	DBS	VCR-1	VCR-2	V.AUX	AUX1	AUX2		
		ON	ON	ON	ON	ON	ON	ON	ON	ON	ON	ON	ON	ON		
4	<b>Display</b> The brightness of the AVR-4306's display can be adjusted	Dimmer = 0	78													
5	<b>Remote Control</b> Set this when you want to select the Network Audio, USB and iPod functions directly from multizone with the remote control unit.	Net Audio Preset Ch	78, 79													
6	<b>iPod Charge</b> Use this to set iPod charging when the AVR-4306 and iPod are connected.	Power On = ON	79													
7	<b>Setup Lock</b> This sets whether or not to lock the system setup settings so that they cannot be changed.	Setup Lock = OFF	79													

7. Network Setup

Network Setup		Default settings	Page
1	<b>IP Address</b> The IP address-related settings are made here.	ON	80
2	<b>Proxy</b> The proxy-related settings can be changed here.	OFF	80
3	<b>Network Option</b> <b>Power saving</b> Set whether or not to accept control from the network in the standby mode.	ON	81
	<b>PC Language</b> Select the language of the computer's OS.	eng	



# Additional Information

## Optimum surround sound for different sources

There are currently various types of multi-channel signals (signals or formats with more than two channels).

### Types of multi-channel signals

Dolby Digital (including Dolby Digital EX), DTS (including DTS-ES), DVD-Audio, and Super Audio CD.

Note on the above: MUSE 3.1 and MPEG multi-channel audio are not available to North American consumers – same is true for Dolby's AAC.

“Source” here does not refer to the type of signal (format) but the recorded content. Sources can be divided into two major categories.

### Types of sources

#### Movie audio:

Signals created to be played in movie theaters. In general sound is recorded to be played in movie theaters equipped with multiple surround speakers, regardless of the format (Dolby Digital, DTS, etc.).

#### Movie theater sound field

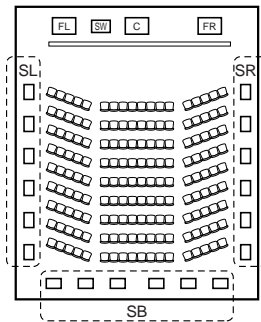

#### Multiple surround speakers

In this case it is important to achieve the same sense of expansion as in a movie theater with the surround channels. To do so, in some cases the number of surround speakers is increased (to four or eight) or speakers with bipolar or dipolar properties are used.

- SL : Surround L channel
- SR : Surround R channel
- SB : Surround B (back) channel

#### Listening room sound field

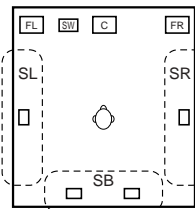

#### Other types of audio:

These signals are designed to recreate a 360° sound field using three to five speakers.

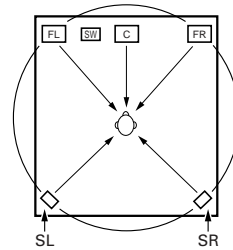

In this case the speakers should surround the listener from all sides to create a uniform sound field from 360°. Ideally the surround speakers should function as “point” sound sources in the same way as the front speakers.

These two types of sources thus have different properties, and different speaker settings, particularly for the surround speakers, are required in order to achieve the ideal sound.

The AVR-4306's surround speaker selection function makes it possible to change the settings according to the combination of surround speakers being used and the surrounding environment in order to achieve the ideal surround sound for all sources. This means that you can connect a pair of bipolar or dipolar surround speakers (mounted on either side of the prime listening position), as well as a separate pair of direct radiating (monopolar) speakers placed at the rear corners of the listening room.

## Surround back speakers

A 6.1-channel system is a conventional 5.1-channel system to which the “surround back” (SB) channel has been added. This makes it easy to achieve sound positioned directly behind the listener, something that was previously difficult with sources designed for conventional multi surround speakers. In addition, the acoustic image extending between the sides and the rear is narrowed, thus greatly improving the expression of the surround signals for sounds moving from the sides to the back and from the front to the point directly behind the listening position.

### Change of positioning and acoustic image with 5.1-channel systems

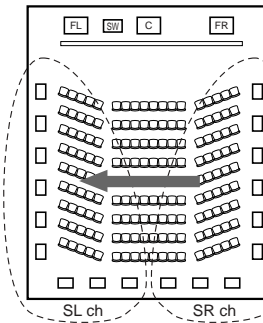

### Movement of acoustic image from SR to SL

### Change of positioning and acoustic image with 6.1-channel systems

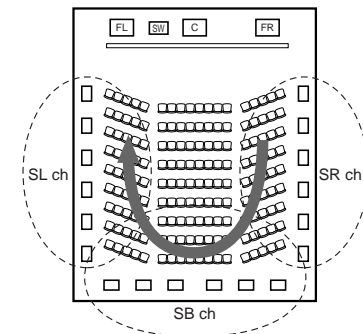

### Movement of acoustic image from SR to SB to SL

## Additional Information

With this set, speaker(s) for 1 or 2 channels are required to achieve a 6.1-channel system (DTS-ES, etc.). Adding these speakers, however, increases the surround effect not only with sources recorded in 6.1 channels but also with conventional 2- to 5.1-channel sources. The WIDE SCREEN mode is a mode for achieving surround sound with up to 7.1 channels using surround back speakers, for sources recorded in conventional Dolby Surround as well as Dolby Digital 5.1-channel and DTS Surround 5.1-channel sources. Furthermore, all the DENON original surround modes (page 37) are compatible with 7.1-channel playback, so you can enjoy 7.1-channel sound with any signal source.

## Number of surround back speakers

Though the surround back channel only consists of 1 channel of playback signals for 6.1-channel sources (DTS-ES, etc.), we recommend using two speakers. When using speakers with dipolar characteristics in particular, it is essential to use two speakers.

Using two speakers results in a smoother blend with the sound of the surround channels and better sound positioning of the surround back channel when listening from a position other than the center.

## Placement of the surround left and right channels when using surround back speakers

Using surround back speakers greatly improves the positioning of the sound at the rear. Because of this, the surround left and right channels play an important role in achieving a smooth transition of the acoustic image from the front to the back. As shown on the diagram above, in a movie theater the surround signals are also produced from diagonally in front of the listeners, creating an acoustic image as if the sound were floating in space.

To achieve these effects, we recommend placing the speakers for the surround left and right channels slightly more towards the front than with conventional surround systems. Doing so sometimes increases the surround effect when playing conventional 5.1-channel sources in the 6.1 surround or DTS-ES Matrix 6.1 mode. Check the surround effects of the various modes before selecting the surround mode.

## Speaker setting examples

Here we describe a number of speaker settings for different purposes. Use these examples as guides to set up your system according to the type of speakers used and the main usage purpose.

### [1] DTS-ES compatible system (using surround back speakers)

#### ① Basic setting for primarily watching movies

This is recommended when mainly playing movies and using regular single way or 2-way speakers for the surround speakers.

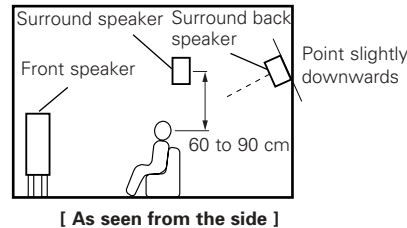
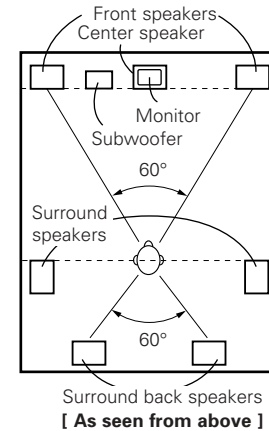

- Set the front speakers with their front surfaces as flush with the TV or monitor screen as possible. Set the center speaker between the front left and right speakers and no further from the listening position than the front speakers.
- Consult the owner's manual for your subwoofer for advice on placing the subwoofer within the listening room.
- If the surround speakers are direct-radiating (monopolar) then place them slightly behind and at an angle to the listening position and parallel to the walls at a position 60 to 90 centimeters (2 to 3 feet) above ear level at the prime listening position.

## Additional Information

- When using two surround back speakers, place them at the back facing the front at a narrower distance than the front left and right speakers. When using one surround back speaker, place it at the rear center facing the front at a slightly higher position (0 to 20 cm) than the surround speakers.
- We recommend installing the surround back speaker(s) at a slightly downward facing angle. This effectively prevents the surround back channel signals from reflecting off the monitor or screen at the front center, resulting in interference and making the sense of movement from the front to the back less sharp.
- Connect the surround speakers to the surround speaker A terminals on the AVR-4306 and set all settings on the setup menu to "A" (This is the factory default setting (page 89)).

#### ② Setting for primarily watching movies using diffusion type speakers for the surround speakers

For the greatest sense of surround sound envelopment, diffuse radiation speakers such as bipolar types, or dipolar types, provide a wider dispersion than is possible to obtain from a direct radiating speaker (monopolar). Place these speakers at either side of the prime listening position, mounted above ear level.

#### Path of the surround sound from the speakers to the listening position

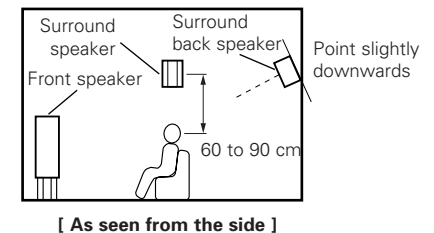
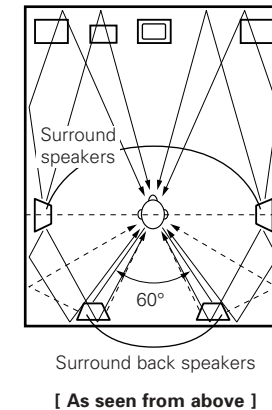

### Additional Information

- Set the front speakers, center speaker and subwoofer in the same positions as in example ①.
  - It is best to place the surround speakers directly at the side or slightly to the front of the viewing position, and 60 to 90 centimeters (2 to 3 feet) above the ears.
  - Same as surround back speaker installation method ①. Using dipolar speakers for the surround back speakers as well is more effective.
  - Connect the surround speakers to the surround speaker A terminals on the AVR-4306 and set all settings on the setup menu to "A" (This is the factory default setting (🔧 page 89)).
  - The signals from the surround channels reflect off the walls as shown on the diagram at the left, creating an enveloping and realistic surround sound presentation.
- For multi-channel music sources however, the use of bipolar or dipolar speakers mounted at the sides of the listening position may not be satisfactory in order to create a coherent 360 degree surround sound field. Connect another pair of direct radiating speakers as described in example ③ and place them at the rear corners of the room facing towards the prime listening position.

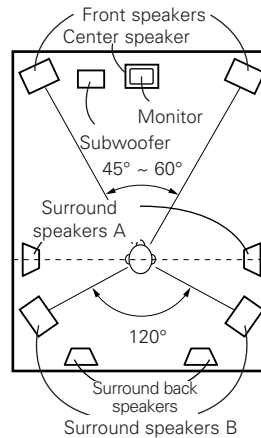

[ As seen from above ]

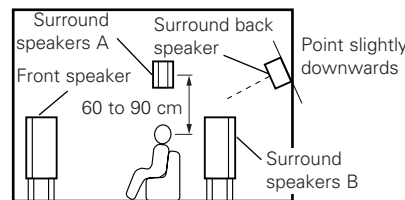

[ As seen from the side ]

### ③ When using different surround speakers for movies and music

To achieve more effective surround sound for both movies and music, use different sets of surround speakers and different surround modes for the two types of sources.

- Set the front speakers slightly wider apart than the setup for watching movies only and point them toward the listening position in order assure clear positioning of the sound.
- Set the center speaker in the same positions as in example ①.
- Set surround speakers A for watching movies in the positions described in example ① or ②, depending on the types of speakers used.
- Set surround speakers B for playing multi-channel music at the same height as the front speakers and slightly at an angle to the rear of the listening position, and point them toward the listening position.
- Connect the surround speakers for watching movies to the surround speaker A terminals on the AVR-4306, the surround speakers for playing multi-channel music to the surround speaker B terminals. Set the surround speaker selection on the setup menu (🔧 page 86).

### Additional Information

#### [2] When not using surround back speakers

- Set the front speakers with their front surfaces as flush with the TV or monitor screen as possible. Set the center speaker between the front left and right speakers and no further from the listening position than the front speakers.
- Consult the owner's manual for your subwoofer for advice on placing the subwoofer within the listening room.
- If the surround speakers are direct-radiating (monopolar) then place them slightly behind and at an angle to the listening position and parallel to the walls at a position 60 to 90 centimeters (2 to 3 feet) above ear level at the prime listening position.
- Connect the surround speakers to the surround speaker A terminals on the AVR-4306 and set all settings on the setup menu to "A" (This is the factory default setting (🔧 page 89)).

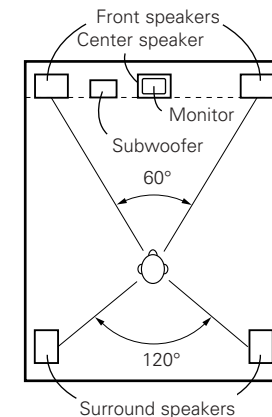

[ As seen from above ]

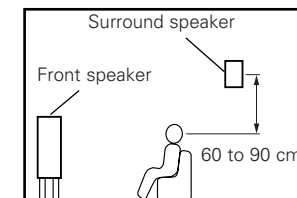

[ As seen from the side ]

## Additional Information

### Surround

The AVR-4306 is equipped with a digital signal processing circuit that lets you play program sources in the surround mode to achieve the same sense of presence as in a movie theater.

## [1] Dolby Surround

### ① Dolby Digital

Dolby Digital is the multi-channel digital signal format developed by Dolby Laboratories.

Dolby Digital consists of up to “5.1” channels - front left, front right, center, surround left, surround right, and an additional channel exclusively reserved for additional deep bass sound effects (the Low Frequency Effects – LFE – channel, also called the “.1” channel, containing bass frequencies of up to 120 Hz). Unlike the analog Dolby Pro Logic format, Dolby Digital’s main channels can all contain full range sound information, from the lowest bass, up to the highest frequencies – 22 kHz. The signals within each channel are distinct from the others, allowing pinpoint sound imaging, and Dolby Digital offers tremendous dynamic range from the most powerful sound effects to the quietest, softest sounds, free from noise and distortion.



## ■ Dolby Digital and Dolby Pro Logic

Comparison of home surround systems	Dolby Digital	Dolby Pro Logic
No. recorded channels (elements)	5.1 ch	2 ch
No. playback channels	5.1 ch	4 ch
Playback channels (max.)	L, R, C, SL, SR, SW	L, R, C, S (SW - recommended)
Audio processing	Digital discrete processing Dolby Digital encoding/decoding	Analog matrix processing Dolby Surround
High frequency playback limit of surround channel	20 kHz	7 kHz

## ■ Dolby Digital compatible media and playback methods

Marks indicating Dolby Digital compatibility: 

The following are general examples. Also refer to the player’s operating instructions.

Media	Dolby Digital output terminals	Playback method (reference page)
DVD ※ 1	Optical or coaxial digital output (same as for PCM) ※ 1	Set the input mode to “AUTO” (  page 27).
Others (satellite broadcasts, CATV, etc.)	Optical or coaxial digital output (same as for PCM)	Set the input mode to “AUTO” (  page 27).

※ 1: Some DVD digital outputs have the function of switching the Dolby Digital signal output method between “bit stream” and “(convert to) PCM”. When playing in Dolby Digital surround on the AVR-4306, switch the DVD player’s output mode to “bit stream”. In some cases players are equipped with both “bit stream + PCM” and “PCM only” digital outputs. In this case connect the “bit stream + PCM” terminals to the AVR-4306.

### ② Dolby Pro LogicII

- Dolby Pro LogicII is a new multi-channel playback format developed by Dolby Laboratories using feedback logic steering technology and offering improvements over conventional Dolby Pro Logic circuits.
- Dolby Pro LogicII can be used to decode not only sources recorded in Dolby Surround (※) but also regular stereo sources into five channels (front left, front right, center, surround left and surround right) to achieve surround sound.
- Whereas with conventional Dolby Pro Logic the surround channel playback frequency band was limited, Dolby Pro LogicII offers a wider band range (20 Hz to 20 kHz or greater). In addition, the surround channels were monaural (the surround left and right channels were the same) with previous Dolby Pro Logic, but Dolby Pro LogicII they are played as stereo signals.
- Various parameters can be set according to the type of source and the contents, so it is possible to achieve optimum decoding ( page 33).

## Additional Information

### ③ Dolby Pro LogicIIx

- Dolby Pro LogicIIx furthers the matrix decoding technology of Dolby Pro LogicII to decode audio signals recorded on two channels into up to 7.1 playback channels, including the surround back channel. Dolby Pro LogicIIx also allows 5.1-channel sources to be played in up to 7.1 channels. The mode can be selected according to the source. The Music mode is best suited for playing music, the Cinema mode for playing movies, and the Game mode for playing games. The Game mode can only be used with 2-channel audio sources.

### ※ Sources recorded in Dolby Surround

- These are sources in which three or more channels of surround have been recorded as two channels of signals using Dolby Surround encoding technology.
- Dolby Surround is used for the sound tracks of movies recorded on DVDs, LDs and video cassettes to be played on stereo VCRs, as well as for the stereo broadcast signals of FM radio, TV, satellite broadcasts and cable TV.
- Decoding these signals with Dolby Pro Logic makes it possible to achieve multi-channel surround playback. The signals can also be played on ordinary stereo equipment, in which case they provide normal stereo sound.
- There are two types of DVD Dolby Surround recording signals.
  - ① 2-channel PCM stereo signals
  - ② 2-channel Dolby Digital signals

## ■ Sources recorded in Dolby Surround are indicated with the logo mark shown below

Dolby Surround support mark: 

Manufactured under license from Dolby Laboratories. “Dolby”, “Pro Logic” and the double-D symbol are trademarks of Dolby Laboratories.

**Additional Information**

**[2] DTS Digital Surround**

DTS Digital Surround (also called simply DTS) is a multi-channel digital signal format developed by Digital Theater Systems.

DTS offers the same “5.1” playback channels as Dolby Digital (front left, front right and center, surround left and surround right) as well as the stereo 2-channel mode. The signals for the different channels are fully independent, eliminating the risk of deterioration of sound quality due to interference between signals, crosstalk, etc.



DTS features a relatively higher bit rate as compared to Dolby Digital (1234 kbps for CDs and LDs, 1536 kbps for DVDs) so it operates with a relatively low compression rate. Because of this the amount of data is great, and when DTS playback is used in movie theaters, a separate CD-ROM synchronized with the film is played.

With LDs and DVDs, there is of course no need for an extra disc; the pictures and sound can be recorded simultaneously on the same disc, so the discs can be handled in the same way as discs with other formats.

There are also music CDs recorded in DTS. These CDs include 5.1-channel surround signals (compared to two channels on current CDs). They do not include picture data, but they offer surround playback on CD players that are equipped with digital outputs (PCM type digital output required).

DTS surround track playback offers the same intricate, grand sound as in a movie theater, right in your own listening room.

**■ DTS compatible media and playback methods**

Marks indicating DTS compatibility:  and 

The following are general examples. Also refer to the player’s operating instructions.

Media	DTS Digital output terminals	Playback method (reference page)
CD	Optical or coaxial digital output (same as for PCM) ※ 2	Set the input mode to “AUTO” or “DTS” (☞ page 27). Never set the mode to “ANALOG” or “PCM”. ※ 1
DVD	Optical or coaxial digital output (same as for PCM) ※ 3	Set the input mode to “AUTO” or “DTS” (☞ page 27).

- ※ 1: DTS signals are recorded in the same way on CDs and LDs as PCM signals. Because of this, the un-decoded DTS signals are output as random “hissy” noise from the CD or LD player’s analog outputs. If this noise is played with the amplifier set at a very high volume, it may possibly cause damage to the speakers. To avoid this, be sure to switch the input mode to “AUTO” or “DTS” before playing CDs or LDs recorded in DTS. Also, never switch the input mode to “ANALOG” or “PCM” during playback. The same holds true when playing CDs or LDs on a DVD player or LD/DVD compatible player. For DVDs, the DTS signals are recorded in a special way so this problem does not occur.
- ※ 2: The signals provided at the digital outputs of a CD or LD player may undergo some sort of internal signal processing (output level adjustment, sampling frequency conversion, etc.). In this case the DTS-encoded signals may be processed erroneously, in which case they cannot be decoded by the AVR-4306, or may only produce noise. Before playing DTS signals for the first time, turn down the master volume to a low level, start playing the DTS disc, then check whether the DTS indicator on the AVR-4306 (☞ page 31) lights before turning up the master volume.
- ※ 3: A DVD player with DTS-compatible digital output is required to play DTS DVDs. A DTS Digital Output logo is featured on the front panel of compatible DVD players. Recent DENON DVD player models feature DTS-compatible digital output – consult the player’s owner’s manual for information on configuring the digital output for DTS playback of DTS-encoded DVDs.

MANUFACTURED UNDER LICENSE FROM DIGITAL THEATER SYSTEMS, INC.  
 U.S. PAT. NO’S. 5,451,942; 5,956,674; 5,974,380; 5,978,762; 6,226,616; 6,487,535 AND OTHER U.S. AND WORLD-WIDE PATENTS ISSUED AND PENDING.  
 “DTS”, “DTS-ES”, “Neo:6”, AND “DTS 96/24” ARE TRADEMARKS OF DIGITAL THEATER SYSTEMS, INC. © 1996, 2003 DIGITAL THEATER SYSTEMS, INC. ALL RIGHTS RESERVED.

**Additional Information**

**[3]DTS-ES**

DTS-ES is a new multi-channel digital signal format developed by Digital Theater Systems, Inc. While offering high compatibility with the conventional DTS Digital Surround format, DTS-ES greatly improves the 360-degree surround impression and space expression thanks to further expanded surround signals. This format has been used professionally in movie theaters since 1999.

In addition to the 5.1 surround channels (FL, FR, C, SL, SR and LFE), DTS-ES also offers the SB (Surround Back, sometimes also referred to as “surround center”) channel for surround playback with a total of 6.1 channels. DTS-ES includes two signal formats with different surround signal recording methods, as described below.

**■ DTS-ES™ Discrete 6.1**

DTS-ES Discrete 6.1 is the newest recording format. With it, all 6.1 channels (including the SB channel) are recorded independently using a digital discrete system. The main feature of this format is that because the SL, SR and SB channels are fully independent, the sound can be designed with total freedom and it is possible to achieve a sense that the acoustic images are moving about freely among the background sounds surrounding the listener from 360 degrees.

Though maximum performance is achieved when sound tracks recorded with this system are played using a DTS-ES decoder, when played with a conventional DTS decoder the SB channel signals are automatically down-mixed to the SL and SR channels, so none of the signal components are lost.

**■ DTS-ES™ Matrix 6.1**

With this format, the additional SB channel signals undergo matrix encoding and are input to the SL and SR channels beforehand. Upon playback they are decoded to the SL, SR and SB channels. The performance of the encoder used at the time of recording can be fully matched using a high precision digital matrix decoder developed by DTS, thereby achieving surround sound more faithful to the producer’s sound design aims than with conventional 5.1- or 6.1-channel systems.

In addition, the bit stream format is 100% compatible with conventional DTS signals, so the effect of the Matrix 6.1 format can be achieved even with 5.1-channel signal sources. Of course it is also possible to play DTS-ES Matrix 6.1 encoded sources with a DTS 5.1-channel decoder.

## Additional Information

When DTS-ES Discrete 6.1 or Matrix 6.1 encoded sources are decoded with a DTS-ES decoder, the format is automatically detected upon decoding and the optimum playing mode is selected. However, some Matrix 6.1 sources may be detected as having a 5.1-channel format, so the DTS-ES Matrix 6.1 mode must be set manually to play these sources. (For instructions on selecting the surround mode (see page 32).)

The DTS-ES decoder includes another function, the DTS Neo:6 surround mode for 6.1-channel playback of digital PCM and analog signal sources.

### ■ DTS Neo:6™ surround

This mode applies conventional 2-channel signals to the high precision digital matrix decoder used for DTS-ES Matrix 6.1 to achieve 6.1-channel surround playback. High precision input signal detection and matrix processing enable full band reproduction (frequency response of 20 Hz to 20 kHz or greater) for all 6.1 channels, and separation between the different channels is improved to the same level as that of a digital discrete system.

DTS Neo:6 surround includes two modes for selecting the optimum decoding for the signal source.

#### • DTS Neo:6 Cinema

This mode is optimum for playing movies. Decoding is performed with emphasis on separation performance to achieve the same atmosphere with 2-channel sources as with 6.1-channel sources.

This mode is effective for playing sources recorded in conventional surround formats as well, because the in-phase component is assigned mainly to the center channel (C) and the reversed phase component to the surround (SL, SR and SB channels).

#### • DTS Neo:6 Music

This mode is suited mainly for playing music. The front channel (FL and FR) signals bypass the decoder and are played directly so there is no loss of sound quality, and the effect of the surround signals output from the center (C) and surround (SL, SR and SB) channels add a natural sense of expansion to the sound field.

### [4] DTS 96/24

The sampling frequency, number of bits and number of channels used for recording of music, etc., in studios has been increasing in recent years, and there are a growing number of high quality signal sources, including 96 kHz/24 bit 5.1-channel sources.

For example, there are high picture/sound quality DVD video sources with 96 kHz/24 bit stereo PCM audio tracks.

However, because the data rate for these audio tracks is extremely high, there are limits to recording them on two channels only, and since the quality of the pictures must be restricted it is common to only include still pictures.

In addition, 96 kHz/24 bit 5.1-channel surround is possible with DVD audio sources, but DVD audio players are required to play them with this high quality.

DTS 96/24 is a multi-channel digital signal format developed by Digital Theater Systems, Inc. in order to deal with this situation. Conventional surround formats used sampling frequencies of 48 or 44.1 kHz, so 20 kHz was about the maximum playback signal frequency. With DTS 96/24, the sampling frequency is increased to 96 or 88.2 kHz to achieve a wide frequency range of over 40 kHz.

In addition, DTS 96/24 has a resolution of 24 bits, resulting in the same frequency band and dynamic range as 96 kHz/24 bit PCM. As with conventional DTS Surround, DTS 96/24 is compatible with a maximum of 5.1 channels, so sources recorded using DTS 96/24 can be played in high sampling frequency, multiple channel audio with such normal media as DVD videos and CDs. Thus, with DTS 96/24, the same 96 kHz/24 bit multi-channel surround sound as with DVD-Audio can be achieved while viewing DVD-Video images on a conventional DVD-Video player (※1). Furthermore, with DTS 96/24 compatible CDs, 88.2 kHz/24 bit multi-channel surround can be achieved using normal CD/LD players (※1).

Even with the high quality multi-channel signals, the recording time is the same as with conventional DTS surround sources.

What's more, DTS 96/24 is fully compatible with the conventional DTS surround format, so DTS 96/24 signal sources can be played with a sampling frequency of 48 kHz or 44.1 kHz on conventional DTS or DTS-ES surround decoders (※2).

※1: A DVD player with DTS digital output capabilities (for CD/LD players, a player with digital outputs for conventional DTS CDs/LDs) and a disc recorded in DTS 96/24 are required.

※2: The resolution is 24 or 20 bits, depending on the decoder.

## Additional Information

### Audyssey MultEQ XT

There are several factors that can degrade the sound from even the best loudspeakers in a listening room. One of the most important is the interaction of sound from the loudspeakers with large surfaces such as walls, the floor, and the ceiling in the room. Even with careful loudspeaker placement and acoustical treatments, there are significant problems that are caused by room acoustics. These include reflections from nearby surfaces and standing waves that are created between large parallel surfaces in the room.

In a home theater the situation is further complicated because there are several listening locations. The effects of room acoustics on the sound arriving at each person's ears are very different and the result is a listening experience that is degraded in a different way for every person in the room. It is not uncommon to have variations in two adjacent seats that are as large as 10 dB, particularly in the frequency range below 250 Hz. The solution to this problem is to apply room correction after precisely measuring how each loudspeaker interacts with the room. Because the room causes variations in the frequency response of the loudspeakers that are so large from seat to seat, it is important to measure each loudspeaker at several locations in the listening room. This should be done even if there is only one listener. Measurement at a single location is not representative of the acoustical problems in the room and will, in most cases, degrade overall performance.

Audyssey MultEQ XT is the only technology that can achieve room correction for multiple listeners in a large listening area. It does so by combining the data collected at several points in the room from each loudspeaker and then applying correction that minimizes the acoustical effects of the room and is matched to the frequency resolution of human perception (known as psychoacoustics). Furthermore, MultEQ XT correction is applied both in frequency and time domains and so there are no artifacts (such as smearing of sound or modal ringing) that are sometimes associated with traditional methods of room equalization.

In addition to correcting frequency response problems over a wide listening area, Audyssey MultEQ XT provides a completely automated sound system set-up process. It identifies how many loudspeakers are connected to the amplifiers and whether they are full-range, satellites, or subwoofers. If there is at least one subwoofer connected, Audyssey MultEQ XT determines the optimum crossover frequency between each satellite and the subwoofer(s). It automatically checks the polarity of each loudspeaker and alerts the user if there are any that may be wired out-of-phase relative to the others. It measures the distance to each loudspeaker from the main listening position and adjusts the delays so that sound from each loudspeaker arrives at the same time. Finally, Audyssey MultEQ XT determines the playback level of each loudspeaker and adjusts the volume trims so that all levels are equal.

## Additional Information

The two diagrams below illustrate two examples of microphone placement for two types of seating arrangements. There are six measuring positions shown in each case. Increasing the number of measuring points will provide a better sampling of the listening area and produce better results. The dotted line represents the area in which the room correction provided by Audyssey MultEQ XT is optimal. The microphone must be placed at ear height at each location.

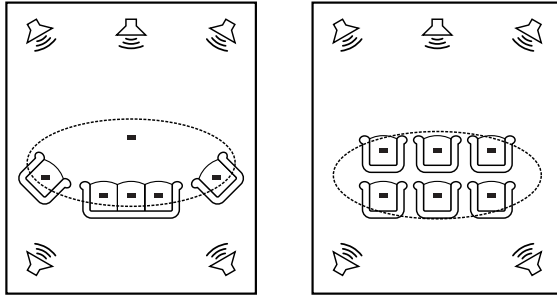

- Audyssey MultEQ XT is a trademark of Audyssey Laboratories. It is licensed under US and National Patent Applications 20030235318 and 10/700,220. Additional U.S. and Foreign Patents pending. MultEQ and the Audyssey MultEQ logo are trademarks of Audyssey Laboratories, Inc.. All rights reserved.

## HDCD® (High Definition Compatible Digital®)

HDCD is an encoding/decoding technology that greatly reduces the distortion that occurs upon digital recording while maintaining compatibility with the conventional CD format, thus expanding the dynamic range and achieving a high resolution. Conventional CDs and HDCD compatible CDs are identified automatically to select the optimum digital processing.



- ®, HDCD®, High Definition Compatible Digital® and Microsoft® are either registered trademarks or trademarks of Microsoft Corporation, Inc. in the United States and/or other countries. HDCD system manufactured under license from Microsoft Corporation, Inc. This product is covered by one or more of the following: In the USA: 5,479,168, 5,638,074, 5,640,161, 5,808,574, 5,838,274, 5,854,600, 5,864,311, 5,872,531, and in Australia: 669114. Other patents pending.

## DENON LINK (DENON Digital Link)

High-grade LPCM 24 bit, 96-kHz, 6-channel or 24-bit, 192 kHz, 2-channel digital input is possible when the AVR-4306 is connected via a shielded twisted pair (STP) cable to a DENON DVD player that supports DENON Digital Link. Since DENON Digital Link uses low-voltage differential signaling (LVDS), transfer capabilities of greater than 1.2 Gbps at a differential voltage of approximately 0.3 Vpp are possible.

## AL24 Plus (AL24 Processing Plus)

### AL24 Processing for All Channels

DENON has further developed its proprietary AL24 Processing, an analog waveform reproduction technology, to support the 192-kHz sampling frequency of DVD-Audio. AL24 Processing Plus, thoroughly suppresses quantization noise associated with D/A conversion of LPCM signals to reproduce the low-level signals with optimum clarity that will bring out all the delicate nuances of the music.

Equipped for not only front left and right channels but also for the surround left and right, center and subwoofer channels.

## About HDMI

“HDMI” is the abbreviation of “High Definition Multimedia Interface”.

This is a digital interface standard for next generation TVs developed based on the DVI (Digital Visual Interface) used for computer displays, etc., and optimized for use in non-professional equipment. With it, non-compressed digital video and multi-channel audio signals can be transferred with a single connector, eliminating the need to use separate cables for the picture and sound and making it possible to make connectors smaller. HDMI is also compatible with HDCP (High-bandwidth Digital Contents Protection), a technology for protecting copyrights that encrypts digital video signals in the same way as with DVI.

## HDMI

- HDMI, the HDMI logo and High-Definition Multimedia Interface are trademarks or registered trademarks of HDMI Licensing LLC.

## Additional Information

## Windows Media Connect

This is a media server provided free of charge by Microsoft since October 2004.

It operates with all types of music jukebox programs, but is optimum with Windows Media Player Ver. 10.

Windows Media Connect can be used to play playlists created on jukebox software such as Windows Media Player Ver. 10, as well as WMA, DRM WMA, MP3 and WAV files.

## Explanation for installing Windows Media Connect

1. If installation of Windows XP Service Pack 2 is not yet complete, either download free of charge from Microsoft or via the Windows Update installer.
2. Download the latest version of Windows Media Player Ver. 10 either directly from Microsoft or using the Windows Update installer.
3. Download Windows Media Connect (usable since October 12, 2004) either directly from Microsoft or using the Windows Update installer.

## vTuner

This is an Internet radio free online contents server. Note that usage fees are included in upgrade costs.

For inquiries about this service, visit the vTuner site below.  
vTuner website: <http://www.radiodenon.com>

This product is protected by certain intellectual property rights of Nothing Else Matters Software and BridgeCo. Use or distribution of such technology outside of this product is prohibited without a license from Nothing Else Matters Software and BridgeCo or an authorized subsidiary.

**Windows Media DRM**

A copyright-protected technology developed by Microsoft.

- The PlaysForSure logo, Windows Media and the Windows logo are trademarks or registered trademarks of Microsoft Corporation in the United States and/or other countries.
- Content providers are using the digital rights management technology for Windows Media contained in this device (“WM-DRM”) to protect the integrity of their content (“Secure Content”) so that their intellectual property, including copyright, in such content is not misappropriated. This device uses WM-DRM software to play Secure Content (“WM-DRM Software”). If the security of the WM-DRM Software in this device has been compromised, owners of Secure Content (“Secure Content Owners”) may request that Microsoft revoke the WM-DRM Software’s right to acquire new licenses to copy, display and/or play Secure Content. Revocation does not alter the WM-DRM Software’s ability to play unprotected content. A list of revoked WM-DRM Software is sent to your device whenever you download a license for Secure Content from the Internet or from PC. Microsoft may, in conjunction with such license, also download revocation list onto your device on behalf of Secure Content Owners.

**Surround modes and parameters**

Surround Mode	Signals and adjustability in the different modes								
	Channel output					Parameter (default values are shown in parentheses)			
	FRONT L/R	CENTER	SURROUND L/R	SURROUND BACK L/R	SUB-WOOFER	D. COMP *1	LFE *2	AFDM *1	SB CH OUT (MODE)
PURE DIRECT, DIRECT	○	×	×	×	⊙	○ (OFF)	○ (0 dB)	×	×
DSD DIRECT	○	×	×	×	⊙	×	○ (0 dB)	×	×
DSD MULTI DIRECT	○	⊙	⊙	⊙	⊙	×	○ (0 dB)	×	○
MULTI CH DIRECT	○	⊙	⊙	⊙	⊙	×	○ (0 dB)	×	○
STEREO	○	×	×	×	⊙	○ (OFF)	○ (0 dB)	×	×
EXT.IN	○	⊙	⊙	⊙	⊙	×	×	×	×
MULTI CH IN	○	⊙	⊙	⊙	⊙	×	○ (0 dB)	×	○
WIDE SCREEN	○	⊙	⊙	⊙	⊙	○ (OFF)	○ (0 dB)	×	○
DOLBY PRO LOGICIIx	○	⊙	⊙	⊙	⊙	○ (OFF)	×	×	○
DOLBY PRO LOGICII	○	⊙	⊙	⊙	⊙	○ (OFF)	×	×	○
DTS NEO:6	○	⊙	⊙	⊙	⊙	○ (OFF)	×	×	○
DOLBY DIGITAL	○	⊙	⊙	⊙	⊙	○ (OFF)	○ (0 dB)	○ (ON)	○
DTS SURROUND	○	⊙	⊙	⊙	⊙	○ (OFF)	○ (0 dB)	○ (ON)	○
7CH STEREO	○	⊙	⊙	⊙	⊙	○ (OFF)	○ (0 dB)	×	○
SUPER STADIUM	○	⊙	⊙	⊙	⊙	○ (OFF)	○ (0 dB)	×	○
ROCK ARENA	○	⊙	⊙	⊙	⊙	○ (OFF)	○ (0 dB)	×	○
JAZZ CLUB	○	⊙	⊙	⊙	⊙	○ (OFF)	○ (0 dB)	×	○
CLASSIC CONCERT	○	⊙	⊙	⊙	⊙	○ (OFF)	○ (0 dB)	×	○
MONO MOVIE	○	⊙	⊙	⊙	⊙	○ (OFF)	○ (0 dB)	×	○
VIDEO GAME	○	⊙	⊙	⊙	⊙	○ (OFF)	○ (0 dB)	×	○
MATRIX	○	⊙	⊙	⊙	⊙	○ (OFF)	○ (0 dB)	×	○
VIRTURL	○	×	×	×	⊙	○ (OFF)	○ (0 dB)	×	○

○ : Signal / Adjustable  
 × : No signal / Not adjustable  
 ⊙ : Turned on or off by speaker configuration setting

○ : Able  
 × : Unable  
 NOTE1 : BASS +6 dB, TREBLE 0 dB  
 NOTE2 : BASS +6 dB, TREBLE +4 dB  
 NOTE3 : This parameter is available when the “MODE” is set to “CINEMA”.  
 NOTE4 : This parameter is available when the “MODE” is set to “CINEMA” or “PL”.  
 \*1: When playing Dolby Digital and DTS signals.  
 \*2: When playing Dolby Digital, DTS, DVD-Audio and Super Audio CD.



Additional Information

Additional Information

Surround Mode	Signals and adjustability in the different modes												
	Parameter (default values are shown in parentheses)												
	TONE CONTROL	CINEMA EQ.	MODE (DECODER)	ROOM SIZE	EFFECT LEVEL	Dolby Digital	DELAY TIME	SUBWOOFER ON/OFF	PRO LOGICII/IIx MUSIC MODE only			NEO:6 MUSIC MODE only	EXT. IN only
NIGHT mode						PANORAMA			DIMENSION	CENTER WIDTH	CENTER IMAGE	SW ATT	
PURE DIRECT, DIRECT	×	×	×	×	×	○ (OFF)	×	○	×	×	×	×	×
DSD DIRECT	×	×	×	×	×	×	×	○	×	×	×	×	×
DSD MULTI DIRECT	×	×	×	×	×	×	×	×	×	×	×	×	×
MULTI CH DIRECT	×	×	×	×	×	×	×	×	×	×	×	×	×
STEREO	○ (0 dB)	×	×	×	×	○ (OFF)	×	×	×	×	×	×	×
EXT.IN	×	×	×	×	×	×	×	×	×	×	×	×	○
MULTI CH IN	○ (0 dB)	×	×	×	×	×	×	×	×	×	×	×	×
WIDE SCREEN	○ (0 dB)	○ (OFF)	×	×	○ (ON, 10)	○ (OFF)	×	×	×	×	×	×	×
DOLBY PRO LOGICIIx	○ (0 dB)	○ (NOTE3)	○ (CINEMA)	×	×	○ (OFF)	×	×	○ (OFF)	○ (3)	○ (3)	×	×
DOLBY PRO LOGICII	○ (0 dB)	○ (NOTE4)	○ (CINEMA)	×	×	○ (OFF)	×	×	○ (OFF)	○ (3)	○ (3)	×	×
DTS NEO:6	○ (0 dB)	○ (NOTE3)	○ (CINEMA)	×	×	○ (OFF)	×	×	×	×	×	○ (0.3)	×
DOLBY DIGITAL	○ (0 dB)	○ (OFF)	×	×	×	○ (OFF)	×	×	×	×	×	×	×
DTS SURROUND	○ (0 dB)	○ (OFF)	×	×	×	○ (OFF)	×	×	×	×	×	×	×
7CH STEREO	○ (0 dB)	×	×	×	×	○ (OFF)	×	×	×	×	×	×	×
SUPER STADIUM	○ (NOTE1)	×	×	○ (Medium)	○ (10)	○ (OFF)	×	×	×	×	×	×	×
ROCK ARENA	○ (NOTE2)	×	×	○ (Medium)	○ (10)	○ (OFF)	×	×	×	×	×	×	×
JAZZ CLUB	○ (0 dB)	×	×	○ (Medium)	○ (10)	○ (OFF)	×	×	×	×	×	×	×
CLASSIC CONCERT	○ (0 dB)	×	×	○ (Medium)	○ (10)	○ (OFF)	×	×	×	×	×	×	×
MONO MOVIE	○ (0 dB)	×	×	○ (Medium)	○ (10)	○ (OFF)	×	×	×	×	×	×	×
VIDEO GAME	○ (0 dB)	×	×	○ (Medium)	○ (10)	○ (OFF)	×	×	×	×	×	×	×
MATRIX	○ (0 dB)	×	×	×	×	○ (OFF)	○ (30 msec)	×	×	×	×	×	×
VIRTURL	○ (0 dB)	×	×	×	×	○ (OFF)	×	×	×	×	×	×	×

○ : Signal / Adjustable  
 × : No signal / Not adjustable  
 ◎ : Turned on or off by speaker configuration setting

○ : Adjustable  
 × : Not adjustable

■ Differences in surround mode names depending on the input signals

Button	Surround Mode	Note	Input signals																
			ANALOG	LINEAR PCM	DTS				DOLBY DIGITAL					DVD-AUDIO			Super Audio CD		
					DTS ES DSCR6.1 (With Flag)	DTS ES MTRX (With Flag)	DTS (5.1ch)	DTS 96/24	DOLBY DIGITAL EX (With Flag)	DOLBY DIGITAL EX (With no Flag)	DOLBY DIGITAL (5.1ch)	DOLBY DIGITAL (3, 4, 5ch)	DOLBY DIGITAL (2ch)	DVD-Audio (multi ch)	DVD-Audio (2ch)	176.4/192kHz	DSD (multi ch)	DSD (2ch)	
STANDARD																			
DTS SURROUND																			
	DTS ES DSCR6.1	*1	×	×	● ◎	×	×	×	×	×	×	×	×	×	×	×	×	×	×
	DTS ES MTRX6.1	*1	×	×	×	● ◎	×	×	×	×	×	×	×	×	×	×	×	×	×
	DTS SURROUND		×	×	○	○	●	×	×	×	×	×	×	×	×	×	×	×	×
	DTS 96/24		×	×	×	×	●	×	×	×	×	×	×	×	×	×	×	×	×
	DTS + PLIIx CINEMA	*2	×	×	○	○	○	○	×	×	×	×	×	×	×	×	×	×	×
	DTS + PLIIx MUSIC	*1	×	×	○	○	○	○	×	×	×	×	×	×	×	×	×	×	×
	DTS + NEO:6	*1	×	×	×	○	○	○	×	×	×	×	×	×	×	×	×	×	×
	DTS NEO:6 CINEMA		○	○	×	×	×	×	×	×	×	×	○	×	○	×	×	×	○
	DTS NEO:6 MUSIC		○	○	×	×	×	×	×	×	×	×	○	×	○	×	×	×	○
DOLBY SURROUND																			
	DOLBY DIGITAL EX	*1	×	×	×	×	×	×	○	○	○	○	×	×	×	×	×	×	×
	DOLBY DIGITAL		×	×	×	×	×	×	○	●	●	●	×	×	×	×	×	×	×
	DOLBY DIGITAL+PLIIx CINEMA	*2	×	×	×	×	×	×	● ◎	○	○	○	×	×	×	×	×	×	×
	DOLBY DIGITAL+PLIIx MUSIC	*1	×	×	×	×	×	×	○	○	○	○	×	×	×	×	×	×	×
	DOLBY PRO LOGICIIx CINEMA		○	○	×	×	×	×	×	×	×	×	●	×	○	×	×	×	○
	DOLBY PRO LOGICIIx MUSIC		○	○	×	×	×	×	×	×	×	×	○	×	○	×	×	×	○
	DOLBY PRO LOGICIIx GAME		○	○	×	×	×	×	×	×	×	×	○	×	○	×	×	×	○
	DOLBY PRO LOGICII CINEMA		○	○	×	×	×	×	×	×	×	×	○	×	○	×	×	×	○
	DOLBY PRO LOGICII MUSIC		○	○	×	×	×	×	×	×	×	×	○	×	○	×	×	×	○
	DOLBY PRO LOGICII GAME		○	○	×	×	×	×	×	×	×	×	○	×	○	×	×	×	○
	DOLBY PRO LOGIC		○	○	×	×	×	×	×	×	×	×	○	×	○	×	×	×	○
MULTI CH IN																			
	MULTI CH IN		×	×	×	×	×	×	×	×	×	×	×	●	×	×	×	●	×
	MULTI IN + PLIIx CINEMA	*2	×	×	×	×	×	×	×	×	×	×	×	○	×	×	×	○	×
	MULTI IN + PLIIx MUSIC	*1	×	×	×	×	×	×	×	×	×	×	×	○	×	×	×	○	×

● : Mode selectable in initial status

◎ : Mode fixed when AFDM is ON

○ : Selectable mode

× : Non-selectable mode

**NOTE :**

\*1: This mode is not available when the Surround Back speaker setup is set to "None".

\*2: This mode is not available when the Surround Back speaker setup is set to "1spkr" or "None".

Button	Surround Mode	Note	Input signals																	
			ANALOG	LINEAR PCM	DTS				DOLBY DIGITAL					DVD-AUDIO			Super Audio CD			
					DTS ES DSCRT (With Flag)	DTS ES MTRX (With Flag)	DTS (5.1ch)	DTS 96/24	DOLBY DIGITAL EX (With Flag)	DOLBY DIGITAL EX (With no Flag)	DOLBY DIGITAL (5.1ch)	DOLBY DIGITAL (3, 4, 5ch)	DOLBY DIGITAL (2ch)	DVD-Audio (multi ch)	DVD-Audio (2ch)	176.4/192kHz	DSD (multi ch)	DSD (2ch)		
DIRECT																				
	DIRECT		○	○	○	○	○	○	○	○	○	○	○	○	○	○	○	○	○	
	DSD DIRECT		×	×	×	×	×	×	×	×	×	×	×	×	×	×	×	×	○	
	DSD MULTI DIRECT		×	×	×	×	×	×	×	×	×	×	×	×	×	×	×	×	○	
	MULTI CH DIRECT		×	×	×	×	×	×	×	×	×	×	×	○	×	×	×	○	×	
	M DIRECT + PLIIx CINEMA	*2	×	×	×	×	×	×	×	×	×	×	×	○	×	×	×	○	×	
	M DIRECT + PLIIx MUSIC	*1	×	×	×	×	×	×	×	×	×	×	×	○	×	×	×	○	×	
PURE DIRECT																				
	PURE DIRECT		○	○	○	○	○	○	○	○	○	○	○	○	○	○	○	○	○	○
	DSD PURE DIRECT		×	×	×	×	×	×	×	×	×	×	×	×	×	×	×	×	○	
	DSD MULTI PURE		×	×	×	×	×	×	×	×	×	×	×	×	×	×	×	×	○	
	MULTI CH PURE DIRECT		×	×	×	×	×	×	×	×	×	×	×	○	×	×	×	○	×	
	M PURE D + PLIIx CINEMA	*2	×	×	×	×	×	×	×	×	×	×	×	○	×	×	×	○	×	
	M PURE D + PLIIx MUSIC	*1	×	×	×	×	×	×	×	×	×	×	×	○	×	×	×	○	×	
DSP SIMULATION																				
	7CH STEREO	*3	○	○	○	○	○	○	○	○	○	○	○	○	○	○	○	○	○	
	WIDE SCREEN		○	○	○	○	○	○	○	○	○	○	○	○	○	○	○	○	○	
	SUPER STADIUM		○	○	○	○	○	○	○	○	○	○	○	○	○	○	○	○	○	
	ROCK ARENA		○	○	○	○	○	○	○	○	○	○	○	○	○	○	○	○	○	
	JAZZ CLUB		○	○	○	○	○	○	○	○	○	○	○	○	○	○	○	○	○	
	CLASSIC CONCERT		○	○	○	○	○	○	○	○	○	○	○	○	○	○	○	○	○	
	MONO MOVIE		○	○	○	○	○	○	○	○	○	○	○	○	○	○	○	○	○	
	VIDEO GAME		○	○	○	○	○	○	○	○	○	○	○	○	○	○	○	○	○	
	MATRIX		○	○	○	○	○	○	○	○	○	○	○	○	○	○	○	○	○	
	VIRTUAL		○	○	○	○	○	○	○	○	○	○	○	○	○	○	○	○	○	
STEREO																				
	STEREO		●	●	○	○	○	○	○	○	○	○	○	○	○	○	○	○	○	

- : Mode selectable in initial status
- : Selectable mode
- × : Non-selectable mode

**NOTE :**

- \*1: This mode is not available when the Surround Back speaker setup is set to "None".
- \*2: This mode is not available when the Surround Back speaker setup is set to "1spkr" or "None".
- \*3: If the Surround Back speaker setup is set to "None", then "5CH STEREO" is displayed.

**Relationship between the video input signal and monitor output according to the video convert settings**

Video convert	Input signals				MONITOR OUT			
	HDMI	COMPONENT	S-VIDEO	VIDEO	HDMI	COMPONENT	S-VIDEO	VIDEO
ON	X	X	X	X	X	X	X	X
	X	X	X	O	VIDEO	VIDEO	VIDEO	VIDEO
	X	X	O	X	S-VIDEO	S-VIDEO	S-VIDEO	S-VIDEO
	X	X	O	O	S-VIDEO	S-VIDEO	S-VIDEO	S-VIDEO
	X	O (1080p)	X	X	X	COMPONENT	X	X
	X	O (480p ~ 720p)	X	X	COMPONENT	COMPONENT	X	X
	X	O (480i/576i)	X	X	COMPONENT	COMPONENT	COMPONENT	COMPONENT
	X	O (1080p)	X	O	VIDEO	COMPONENT *1	VIDEO	VIDEO
	X	O (480p ~ 720p)	X	O	COMPONENT *1	COMPONENT *1	X *3	VIDEO
	X	O (480i/576i)	X	O	COMPONENT *1	COMPONENT *1	COMPONENT	VIDEO
	X	O (1080p)	O	X	S-VIDEO	COMPONENT *2	S-VIDEO	S-VIDEO
	X	O (480p ~ 720p)	O	X	COMPONENT *2	COMPONENT *2	S-VIDEO	S-VIDEO
	X	O (480i/576i)	O	X	COMPONENT *2	COMPONENT *2	S-VIDEO	S-VIDEO
	X	O (1080p)	O	O	S-VIDEO	COMPONENT *2	S-VIDEO	S-VIDEO
	X	O (480p ~ 720p)	O	O	COMPONENT *2	COMPONENT *2	S-VIDEO	S-VIDEO
	X	O (480i/576i)	O	O	COMPONENT *2	COMPONENT *2	S-VIDEO	S-VIDEO
	O	X	X	X	HDMI	X	X	X
	O	X	X	O	HDMI *1	VIDEO	VIDEO	VIDEO
	O	X	O	X	HDMI *2	S-VIDEO	S-VIDEO	S-VIDEO
	O	X	O	O	HDMI *2	S-VIDEO	S-VIDEO	S-VIDEO
	O	O (Other than 480i/576i)	X	X	HDMI	COMPONENT	X	X
	O	O (480i/576i)	X	X	HDMI	COMPONENT	COMPONENT	COMPONENT
	O	O (1080p)	X	O	HDMI *1	COMPONENT *1	VIDEO	VIDEO
	O	O (480p ~ 720p)	X	O	HDMI *1	COMPONENT *1	X *3	VIDEO
	O	O (480i/576i)	X	O	HDMI *1	COMPONENT *1	COMPONENT	VIDEO
	O	O (Other than 480i/576i)	O	X	HDMI *2	COMPONENT *2	S-VIDEO	S-VIDEO
	O	O (480i/576i)	O	X	HDMI *2	COMPONENT *2	S-VIDEO	S-VIDEO
	O	O (Other than 480i/576i)	O	O	HDMI *2	COMPONENT *2	S-VIDEO	S-VIDEO
O	O (480i/576i)	O	O	HDMI *2	COMPONENT *2	S-VIDEO	S-VIDEO	

O : Signal input  
 X : No signal

480p ~ 720p : 480p/576p/1080i/720p

X : Not output  
 \*1 : On screen display superimposed on video signal and output.  
 \*2 : On screen display superimposed on S-Video signal and output.  
 \*3 : Video signals are output when the analog to HDMI convert function is set to "OFF".

COMPONENT : On screen display only displayed for **SYSTEM SETUP**, **SURROUND PARAMETER** and **ON SCREEN** buttons.

HDMI : The on screen display is displayed when the analog to HDMI convert function is set to "ON".

■ : Video signals are not output when the analog to HDMI convert function is set to "OFF".



- The MAIN ZONE video conversion function is compatible with the following format: NTSC, PAL, SECAM, NTSC4.43, PAL-N, PAL-M and PAL-60.
- When SECAM signals of video input are up-converted, the signals are output in PAL format from the S-Video connector.
- When the input signal is a component 1080i or 720p signal, the signal up-converted to HDMI is output with that resolution.
- When the input signal is a video, S-Video or component 480i, 480p, 576i or 576p signals, the signal up-converted to HDMI is output according to the setting made at "Resolution" under "HDMI Out Setup" (page 72).
- Signals up-converted to HDMI are output to the HDMI monitor with the resolution at which they are input. Note that resolutions of 1080p are not handled.

Additional Information

Additional Information

Video convert	S-VIDEO MONITOR OUT	Input signals				MONITOR OUT			
		HDMI	COMPONENT	S-VIDEO	VIDEO	HDMI	COMPONENT	S-VIDEO	VIDEO
OFF	-	X	X	X	X	X	X	X	X
	-	X	X	X	O	X	X	X	VIDEO
	-	X	X	O	X	X	X	S-VIDEO	X
	Used	X	X	O	O	X	X	S-VIDEO	VIDEO *2
	Not used	X	X	O	O	X	X	-	VIDEO
	-	X	O	X	X	X	COMPONENT	X	X
	-	X	O	X	O	X	COMPONENT *1	X	VIDEO
	-	X	O	O	X	X	COMPONENT *2	S-VIDEO	X
	Used	X	O	O	O	X	COMPONENT *2	S-VIDEO	VIDEO *2
	Not used	X	O	O	O	X	COMPONENT *1	-	VIDEO
	-	O	X	X	X	HDMI	X	X	X
	-	O	X	X	O	HDMI	X	X	VIDEO
	-	O	X	O	X	HDMI	X	S-VIDEO	X
	Used	O	X	O	O	HDMI	X	S-VIDEO	VIDEO *2
	Not used	O	X	O	O	HDMI	X	-	VIDEO
	-	O	O	X	X	HDMI	COMPONENT	X	X
	-	O	O	X	O	HDMI	COMPONENT *1	X	VIDEO
	-	O	O	O	X	HDMI	COMPONENT *2	S-VIDEO	X
Used	O	O	O	O	HDMI	COMPONENT *2	S-VIDEO	VIDEO *2	
Not used	O	O	O	O	HDMI	COMPONENT *1	-	VIDEO	

O : Signal input  
X : No signal

X : Not output  
\*1 : On screen display superimposed on video signal and output.  
\*2 : On screen display superimposed on S-Video signal and output.  
COMPONENT : On screen display only displayed for **SYSTEM SETUP**,  
**SURROUND PARAMETER** and **ON SCREEN** buttons.  
HDMI : The on screen display is displayed when the analog to HDMI  
convert function is set to "ON".

# Troubleshooting

If a problem should arise, first check the following.

1. Are the connections correct?

2. Have you operated the receiver according to the Operating Instructions?

3. Are the speakers and other components operating properly?

If this unit is not operating properly, check the items listed in the table below. Should the problem persist, there may be a malfunction. Disconnect the power immediately and contact your store of purchase.

Symptom	Cause	Measures	Page
Display not lit and sound not produced when POWER switch set to on.	<ul style="list-style-type: none"> <li>Power supply cord not plugged in securely.</li> </ul>	<ul style="list-style-type: none"> <li>Check the insertion of the power supply cord plug.</li> </ul>	23
Display lit but sound not produced.	<ul style="list-style-type: none"> <li>Speaker cables not securely connected.</li> </ul>	<ul style="list-style-type: none"> <li>Connect securely.</li> </ul>	7
	<ul style="list-style-type: none"> <li>FUNCTION knob position is not appropriate.</li> </ul>	<ul style="list-style-type: none"> <li>Switch to the proper position.</li> </ul>	25
	<ul style="list-style-type: none"> <li>Volume control set to minimum.</li> </ul>	<ul style="list-style-type: none"> <li>Turn volume up to suitable level.</li> </ul>	25
	<ul style="list-style-type: none"> <li>MUTING is on.</li> <li>No digital signal is being input.</li> </ul>	<ul style="list-style-type: none"> <li>Switch off MUTING.</li> <li>Properly select a digital signal input source.</li> </ul>	26 67
Nothing is displayed on monitor.	<ul style="list-style-type: none"> <li>AVR-4306's video output terminals and monitor's input terminals are not properly connected.</li> </ul>	<ul style="list-style-type: none"> <li>Check that the connections are correct.</li> </ul>	8, 14-23
	<ul style="list-style-type: none"> <li>Monitor TV's input setting is wrong.</li> <li>The PURE DIRECT mode is set.</li> </ul>	<ul style="list-style-type: none"> <li>Set the TV's input selector to the terminals to which video signals are connected.</li> <li>Set a surround mode other than the PURE DIRECT mode.</li> </ul>	— 30
No DTS sound is produced.	<ul style="list-style-type: none"> <li>DVD player's audio output setting is not set to bit stream.</li> </ul>	<ul style="list-style-type: none"> <li>Make the DVD player's initial settings.</li> </ul>	—
	<ul style="list-style-type: none"> <li>DVD player is not DTS-compatible.</li> </ul>	<ul style="list-style-type: none"> <li>Use a DTS-compatible player.</li> </ul>	—
	<ul style="list-style-type: none"> <li>AVR-4306's input setting is set to analog</li> </ul>	<ul style="list-style-type: none"> <li>Set to AUTO or DTS.</li> </ul>	27
Copying from DVD to VCR is not possible.	<ul style="list-style-type: none"> <li>Copying between a source such as DVD and a VCR is not usually possible, as DVDs are often encoded with copy-protection signals that prevent VCR recording.</li> </ul>	<ul style="list-style-type: none"> <li>Copying is not possible.</li> </ul>	—
No sound is produced from subwoofer.	<ul style="list-style-type: none"> <li>Subwoofer's power is not on.</li> </ul>	<ul style="list-style-type: none"> <li>Turn on the power.</li> </ul>	—
	<ul style="list-style-type: none"> <li>Subwoofer's initial setting is set to "NO".</li> </ul>	<ul style="list-style-type: none"> <li>Set the setting to "YES".</li> </ul>	82
	<ul style="list-style-type: none"> <li>Subwoofer's output is not connected.</li> <li>The subwoofer's channel volume level is set to "OFF".</li> </ul>	<ul style="list-style-type: none"> <li>Connect properly.</li> <li>Turn the subwoofer's channel volume level up.</li> </ul>	7, 23 39

Symptom	Cause	Measures	Page
No test tones are produced.	<ul style="list-style-type: none"> <li>Surround mode is set to a mode other than Dolby Surround.</li> </ul>	<ul style="list-style-type: none"> <li>Set to Dolby Surround.</li> </ul>	—
No sound is produced from surround speakers.	<ul style="list-style-type: none"> <li>Surround mode is set to "STEREO".</li> </ul>	<ul style="list-style-type: none"> <li>Set to a mode other than "STEREO".</li> </ul>	—
This unit does not operate properly when remote control unit is used.	<ul style="list-style-type: none"> <li>Batteries dead.</li> </ul>	<ul style="list-style-type: none"> <li>Replace with new batteries.</li> </ul>	3
	<ul style="list-style-type: none"> <li>Remote control unit too far from this unit.</li> </ul>	<ul style="list-style-type: none"> <li>Move closer.</li> </ul>	3
	<ul style="list-style-type: none"> <li>Obstacle between this unit and remote control unit.</li> <li>Different button is being pressed.</li> <li>⊕ and ⊖ ends of batteries inserted in reverse.</li> </ul>	<ul style="list-style-type: none"> <li>Remove obstacle.</li> <li>Press the proper button.</li> <li>Insert batteries properly.</li> </ul>	3 — 3
An image is not projected with an HDMI connection.	<ul style="list-style-type: none"> <li>AVR-4306's HDMI output terminals and monitor's input terminals are not properly connected.</li> </ul>	<ul style="list-style-type: none"> <li>Check the HDMI connection.</li> </ul>	22
	<ul style="list-style-type: none"> <li>No HDMI signal is being input.</li> </ul>	<ul style="list-style-type: none"> <li>Properly select HDMI signal input source.</li> </ul>	71
	<ul style="list-style-type: none"> <li>The connected monitor equipment or other equipments do not support HDCP.</li> </ul>	<ul style="list-style-type: none"> <li>The AVR-4306 will not output video signal unless the other equipment supports HDCP.</li> </ul>	20
	<ul style="list-style-type: none"> <li>The output format of the connected player (HDMI FORMAT) does not match the supported input format of connected monitor equipments.</li> </ul>	<ul style="list-style-type: none"> <li>Check whether the output format of the connected player (HDMI FORMAT) matches the supported input format of connected monitor equipments.</li> </ul>	20
The HDMI audio is not output.	<ul style="list-style-type: none"> <li>The AVR-4306 does not play HDMI audio signals.</li> </ul>	<ul style="list-style-type: none"> <li>Set the HDMI audio playback setting at the "HDMI In Assign" settings to "AMP".</li> </ul>	71
	<ul style="list-style-type: none"> <li>The HDMI audio signals are not output from the connected monitor device.</li> </ul>	<ul style="list-style-type: none"> <li>Set the HDMI audio playback setting at the "HDMI In Assign" settings to "TV".</li> </ul>	71
Power has turned off and the power indicator is flashing red.	<ul style="list-style-type: none"> <li>The set's internal temperature has risen and the protection circuit has been activated.</li> </ul>	<ul style="list-style-type: none"> <li>Put the AVR-4306 in a well-ventilated place.</li> <li>Turn off the power, then wait for the set to fully cool off before turning the power back on.</li> </ul>	7 7
	<ul style="list-style-type: none"> <li>The core wires of the speaker cables are touching each other or the AVR-4306's rear panel, activating the protection circuit.</li> </ul>	<ul style="list-style-type: none"> <li>Check the connections of all the speaker cables.</li> </ul>	7
	<ul style="list-style-type: none"> <li>AVR-4306 is malfunctioning.</li> </ul>	<ul style="list-style-type: none"> <li>Turn off the power and contact a DENON customer service center.</li> </ul>	7
Sound is only produced from the center speaker.	<ul style="list-style-type: none"> <li>You are playing a monaural source (TV, AM radio broadcast, etc.) in the DOLBY/DTS SURROUND mode.</li> </ul>	<ul style="list-style-type: none"> <li>When playing monaural sources, select a surround mode other than DOLBY/DTS SURROUND mode.</li> </ul>	36, 37

Troubleshooting

Symptom	Cause	Measures	Page
"CHECK ANTENNA" is displayed in the XM mode.	• AVR-4306's XM terminal and the XM Connect-and-Play antenna is not properly connected.	• Check that the connection are correct.	21
"NO SIGNAL" is displayed in the XM mode.	• The signal cannot be received.	• Reposition your XM Connect-and-Play antenna.	42
"OFF AIR" is displayed in the XM mode.	• The selected channel is not currently broadcasting.	• Select the another channel.	42, 43
Receiving only XM channels 0 and 1.	• The XM Tuner is not activated.	• Contact XM Radio.	42

# Specifications

■ **Audio section**

• **Power amplifier**

**Rated output:**

Front:  
 130 W + 130 W (8 Ω/ohms, 20 Hz ~ 20 kHz with 0.05 % T.H.D.)  
 170 W + 170 W (6 Ω/ohms, 1 kHz with 0.7 % T.H.D.)

Center:  
 130 W (8 Ω/ohms, 20 Hz ~ 20 kHz with 0.05 % T.H.D.)  
 170 W (6 Ω/ohms, 1 kHz with 0.7 % T.H.D.)

Surround (A, B):  
 130 W + 130 W (8 Ω/ohms, 20 Hz ~ 20 kHz with 0.05 % T.H.D.)  
 170 W + 170 W (6 Ω/ohms, 1 kHz with 0.7 % T.H.D.)

Surround Back:  
 130 W + 130 W (8 Ω/ohms, 20 Hz ~ 20 kHz with 0.05 % T.H.D.)  
 170 W + 170 W (6 Ω/ohms, 1 kHz with 0.7 % T.H.D.)

**Dynamic power:**

150 W x 2 ch (8 Ω/ohms)  
 220 W x 2 ch (4 Ω/ohms)

**Output terminals:**

Front, Center, Surr. Back 6 ~ 16 Ω/ohms  
 Surround: A or B 6 ~ 16 Ω/ohms  
 A + B 8 ~ 16 Ω/ohms

• **Analog**

**Input sensitivity / input impedance:**

200 mV / 47 kΩ/kohms

**Frequency response:**

10 Hz ~ 100 kHz: +0, -3 dB (DIRECT mode)

**S/N:**

102 dB (DIRECT mode)

**Distortion:**

0.005% (20 Hz ~ 20 kHz) (DIRECT mode)

**Rated output:**

1.2 V

• **Digital**

**D/A output:**

Rated output — 2 V (at 0 dB playback)  
 Total harmonic distortion — 0.008 % (1 kHz, at 0 dB)  
 S/N ratio — 102 dB  
 Dynamic range — 100 dB  
 Format — Digital audio interface

**Digital input:**

• **Phono equalizer (PHONO input — REC OUT)**

**Input sensitivity:**

2.5 mV

**RIAA deviation:**

±1 dB (20 Hz to 20 kHz)

**S/N:**

74 dB (A weighting, with 5 mV input)

**Rated output / Maximum output:**

150 mV / 8 V

**Distortion factor:**

0.03% (1 kHz, 3 V)

■ **Video section**

• **Standard video terminals**

**Input / output level and impedance:** 1 Vp-p, 75 Ω/ohms

**Frequency response:**

5 Hz ~ 10 MHz — +0, -3 dB

• **S-Video terminals**

**Input / output level and impedance:**

Y (brightness) signal — 1 Vp-p, 75 Ω/ohms

C (color) signal — 0.286 Vp-p, 75 Ω/ohms

**Frequency response:**

5 Hz ~ 10 MHz — +0, -3 dB

• **Color component video terminal**

**Input / output level and impedance:**

Y (brightness) signal — 1 Vp-p, 75 Ω/ohms

Pb/Cb signal — 0.7 Vp-p, 75 Ω/ohms

Pr/Cr signal — 0.7 Vp-p, 75 Ω/ohms

**Frequency response:**

5 Hz ~ 100 MHz — +0, -3 dB

■ **Tuner section**

[FM]

[AM]

(note: μV at 75 Ω/ohms, 0 dBf = 1 x 10<sup>-15</sup> W)

**Receiving Range:**

87.5 MHz ~ 107.9 MHz

520 kHz ~ 1710 kHz

**Usable Sensitivity:**

1.0 μV (11.2 dBf)

18 μV

**50 dB Quieting Sensitivity:**

MONO 1.6 μV (15.3 dBf)

STEREO 23 μV (38.5 dBf)

**S/N (IHF-A):**

MONO 77 dB

STEREO 72 dB

**Total Harmonic Distortion (at 1 kHz):**

MONO 0.15%

STEREO 0.3%

■ **General**

**Power supply:**

AC 120 V, 60 Hz

**Power consumption:**

8.0 A

1 W Max (Standby)

**Maximum external dimensions:**

434 (W) x 171 (H) x 429 (D) mm (17-3/32" x 6-47/64" x 16-57/64")

**Mass:**

18.5 kg (40 lbs 12.6 oz)

■ **Remote control unit (RC-1024)**

**Batteries:**

LR6/AA Type (two batteries)

**External dimensions:**

63 (W) x 238 (H) x 31 (D) mm (2-31/64" x 9-3/8" x 1-7/32")

**Mass:**

190 g (Approx. 6.7 oz) (including batteries)

\* For purposes of improvement, specifications and design are subject to change without notice.

## ■ List of preset codes / Liste de codes pré-réglés

### DVD

3D Lab	40539
Acoustic Solutions	40713, 40730, 41242
Advent	41016
AEG	40770, 40790
AFK	41051
Afreey	40698
Aim	40699, 40778, 40833, 41165
Airis	41250
Aiwa	40533, 40641
Akai	40690, 40705, 40770, 40790, 40884, 40899, 41089, 41115
Akira	40699
Akura	41051
Alba	40539, 40672, 40695, 40699, 40713, 40717, 40730, 40783, 41051
Alco	40790
Allegro	40869
Amitech	40770, 40784, 40850
Amphion Media Works	40872
Amstrad	40713
AMW	40872
Ansonic	40774, 40831
Apex	40672, 41061
Apex Digital	40672, 40717, 40755, 40794, 40796, 40797, 40830, 41004, 41020, 41056, 41061, 41100
Arianet	40770
Aspire Digital	41168, 41407
Audiosonic	40690, 41265
Audiovox	40717, 40790, 41041, 41071, 41072, 41121, 41122
Awa	40730, 40872
Axion	40730, 41071, 41072
B & K	40655, 40662

Basic Line	40713
Baze	41165
Bellagio	41004
Black Diamond	40698, 40713, 40833, 40884
Blaupunkt	40717
Blue Parade	40571
Blue Sky	40651, 40672, 40695, 40713, 40769, 40778, 40804
Boghe	41004
Boman	40783
Brainwave	40770, 41115
Brandt	40503, 40651
Broksonic	40695, 40868
Bush	40516, 40672, 40690, 40695, 40699, 40713, 40717, 40730, 40778, 40831, 40833, 40884, 41051, 41165
C-Tech	40798
Cambridge Soundworks	40690
Cat	40699, 41087
CAVS	41057
CCE	40730
Celestial	41020
Centrex	40672, 41004
Centrum	40713
CGV	41115
Changhong	40627, 41061
Cinea	40831
Cineral	40730
Cinetec	40713
cineULTRA	40699
CineVision	40833, 40869, 40876
Citizen	41277
Classic	40730, 41730

Clatronic	40672, 41165
Clayton	40713
Coby	40730, 40770, 40778, 40852, 41086, 41107, 41115, 41165, 41177, 41351
Compacks	40826, 41265
Conia	40516, 40672, 40798, 40852, 41004
Continental Edison	40768, 40831
Craig	40831
Crown	40690, 40769, 40770, 41115
Curtis Mathes	41087
Cybercom	40831
CyberHome	40816, 40874, 41023, 41024, 41117, 41129
Cyductin	41074
Cytron	40651, 40774
D-Vision	41115
Daenyx	40872
Daewoo	40705, 40770, 40784, 40833, 40869, 40872, 41169, 41172, 41234, 41242
Daewoo International	40872
Dansai	40770, 40783, 41115
Dantax	40539, 40713, 40790, 41089
Daytek	40872
Dayton	40872
DCE	40831
DEC	40774, 40778
Decca	40770, 41115
Denon	40490, 40634, <b>*[41470]</b> , 41634
Denver	40699, 40778, 41107, 41165, 41353, 41359
Desav	40770
Desay	40800, 41407
Diamond	40651, 40768, 40790
Dick Smith Electronics	40833, 41730
Digihome	40713



digiRED	40717
Digitor	40651, 40690
Digitrex	40672, 41056, 41100
DIGIXmedia	40826
DiK	40774, 40831
Disney	40675, 41270
DiViDo	40705
DK Digital	40831
DMTech	40783
Dragon	40831
DSE	40833, 41730
Dual	40651, 40713, 40730, 40783, 40790, 40831, 41068, 41085
Durabrand	40713, 40831, 41003, 41127
DVD2000	40521
DVX	40768
ECC	40730
Electrohome	40770, 40784
Elfunk	40850
Elin	40770
Ellion	40850
Elta	40672, 40690, 40770, 40850, 41051, 41115
Emerson	40591, 40675, 40705, 40816, 40821, 41268
Encore	40698
Enterprise	40591
Enzer	40770, 40784
EuroLine	41115
Fenner	40651, 40769
Ferguson	40651
Finlux	40591, 40672, 40741, 40770, 40783, 41165
Fintec	40784, 41169
Firstline	40651, 40713, 40869
Fisher	40670
Funai	40675, 40695, 41334
Gateway	41073, 41077, 41158

GE	40522, 40717, 40815
General Electric	40717
Global Solutions	40768
Go Video	40715, 40741, 40744, 40783, 40833, 40869, 41044, 41075, 41099, 41144, 41158, 41304, 41730
Go Vision	41071, 41072
GoldStar	40591, 40741
Goodmans	40651, 40690, 40713, 40730, 40783, 40790, 40833, 41004, 41730
GPX	40699, 40769
Gradiente	40651
Gran Prix	40831
Grandin	40672, 40713
Greenhill	40717
Grundig	40539, 40651, 40670, 40695, 40705, 40713, 40790, 41004, 41730
Grunkel	40770
GVG	41169
H & B	40850
H&B	40713, 40850
Hanseatic	40741, 40783
Harman/Kardon	40582, 40702
HDT	40705
Hen	40713
Hher	40651, 40713, 40826, 40831
Hitachi	40573, 40664, 40695, 40713, 41247
Hiteker	40672, 40872
Home Electronics	40730
Home Tech	41107
Humax	40646
Hyundai	40768, 40783, 40850
I-Lo	41348
iLo	41348
Initial	40717, 40839
Integra	40571, 40627, 41634
IRT	40783

ISP	40695
Jaton	41078
JBL	40702
Jeken	40699
Jensen	41016
Jepssen	41250
JMB	40695
JNC	40672
JSI	41423
JVC	40503, 40539, 40558, 40623, 40867, 41164
jWin	41049, 41051
Karcher	40783
Kawasaki	40790
Kendo	40699, 40713, 40831
Kennex	40713, 40770
Kenwood	40490, 40534
Kiiro	40770
KLH	40717, 40790, 41020, 41149
KLH Digital	40717
Konka	40711, 40719, 40720, 40721
Koss	40651, 40896, 41423
Landel	40826
Lasonic	40798, 41173
Lawson	40768
Lenco	40651, 40699, 40713, 40770, 40774, 40778, 41165
Lenoxx	40690, 41127
Lexia	40699, 40768
LG	40591, 40741, 40790, 40801, 40869, 40036
Lifetec	40651, 40831
Limit	40768
LiteOn	41058, 41158, 41416, 41440
Loewe	40511, 40539, 40741
Logix	40705, 40783
Lumatron	40705, 40741, 40833, 41115

Lunatron	40741
Luxman	40573
Luxor	40713, 41004, 41730
Magnasonic	40651, 40769
Magnavox	40503, 40539, 40646, 40675, 40713, 40821
Magnex	41165
Malata	40782, 41159
Manhattan	40705, 40713
Marantz	40539
Mark	40713
Marquant	40770
Matsui	40651, 40672, 40695, 40713, 40884, 41004, 41730
Maxim	40713, 40872
MBO	40690, 40730, 41730
MDS	40778
Mecotek	40770
Medion	40630, 40651, 40770, 40774, 40783, 40820, 40831
MEI	40790
Memorex	40695, 40831, 41270
Metronic	40690
Metz	40525, 40571, 40713
Micromedia	40503, 40539
Micromega	40539
Microsoft	40522
Microstar	40831
Minato	40752
Minax	40713
Minerva	40705
Minoka	40770
Minowa	41165
Mintek	40717, 40839
Mirror	40752
Mitsubishi	40521, 40713, 41403, 41521
Mizuda	40770
Momitsu	41082

MTlogic	41265
Mustek	40730, 41730
Mx Onda	40651
NAD	40591, 40692, 40741
Naiko	40770, 41004
Narita	41115
NEC	40591, 40692, 40785, 40869, 41404
Nesa	40717
Nevir	40770, 40831
NextBase	40826
NexxTech	41402
Nintaus	41051
Norcent	40872, 41003, 41107, 41265
Nordmende	40774, 40831
Noriko	40752
Nu-Tec	40516
Okano	40752
Olidata	40672
Omni	40690, 40698, 40778, 40833
Onix	40672, 40852
Onkyo	40503, 40627, 40792
Oopla	41158
Optimus	40525
OptoMedia Electronics	40896
Orion	40695
Oritron	40651
Ormond	40713
Otic	40826
P&B	40770
Pacific	40695, 40713, 40768, 40774, 40790, 40804, 40831
Packard Bell	40770
Palladium	40695
Palsonic	40672, 40852
Panasonic	40490, 40503, 40703, 41362, 41462, 41490, 41762

Panda	40717
Philco	40690, 40790
Philips	40503, 40539, 40646, 40675, 40854, 41158, 41260, 41267, 41354
Phonotrend	40672, 40699, 41165
Pioneer	40490, 40525, 40571, 40631
Plu2	40850
Pointer	40784
Polaroid	41020, 41061, 41086
Polk Audio	40539
Portland	40770
Powerpoint	40872
Powtek	40852
Prima	41016
Prinz	40831
Prism	40705
Proline	40651, 40672, 40833, 41004
Proscan	40522
Proson	40713
Prosonic	40752
ProVision	40699, 40778
Qwestar	40651
Radionette	40741, 40869
RCA	40522, 40571, 40717, 40769, 40790, 40822, 41022, 41132
REC	40490
Recco	40698
Red Star	40770, 41003
Reoc	40752, 40768
Resonance	40651
Revoy	40699
Rio	40869
RJTech	41360
Roadstar	40690, 40699, 40713, 40730, 40833, 41051
Ronin	40872
Rotel	40558, 40623

Rowa	40516, 40717, 40823, 40872, 41004
Saba	40651, 40769
Sabaki	40798
Saivod	40831
Sakyno	40768
Salora	40741
Sampo	40698, 40752
Samsung	40490, 40573, 40744, 40820, 40899, 41044, 41075
Sansui	40695, 40768, 40784
Sanyo	40670, 40695, 40873
Scan	40705, 40850
ScanMagic	40730
Schaub Lorenz	40770, 41115
Schneider	40539, 40651, 40705, 40713, 40774, 40783, 40790, 40804, 40831
Schwaiger	40752
Scientific Labs	40768, 40798
Scott	40651, 40672, 40797
SEG	40713, 40768, 40798, 40872, 40884
Semp	40503
Sensory Science	41158
Shanghai	40672
Sharp	40630, 40675, 40713, 40752, 41256
Sharper Image	41117
Sherwood	40633, 40717, 40741, 40770, 41043, 41077
Shinco	40717
Shinsonic	40533, 40839
Silva	40831
Silva Schneider	40831
Singer	40690, 40768
Skantic	40539, 40713, 41003
Skymaster	40730, 40768
Slim Art	40784
Slim Devices	40533
SM Electronic	40690, 40730, 40768

Smart	40705, 40713
Sonai	40755
Sonashi	40831
Sonic Blue	40783, 40869, 41099
Sony	40533, 40573, 40864, 41033, 41431, 41533
Soundmaster	40768
Soundmax	40768
Soundwave	40783
Sova	41122
Spectra	40872
Standard	40651, 40768, 40831
Star Cluster	40768
Strong	40713
Sungale	41074
Sunkai	40770, 40850
Sunstech	40831
Superscan	40821
Supervision	40768
SVA	40672, 40717, 40860, 41105
Sylvania	40630, 40675, 40821, 41268
Symphonic	40675
Synn	40768
Tandberg	40713
Tatung	40770
Teac	40516, 40571, 40692, 40695, 40717, 40741, 40768, 40790, 40809, 40833, 41051
Technics	40490, 40703
Technika	40768, 40770, 40831, 41115, 41165
Technisson	41115
Technosonic	40730, 41051, 41115
Techwood	40692, 40713
Tedex	40690, 40768, 41004
Telefunken	40770, 40790, 40833
Teletch	40713, 40768
Tensai	40651, 40690, 40770

Terapin	41031
Tevion	40651, 40768, 40798, 40833
Theta Digital	40571
Thomson	40522
Tokai	40698, 40784, 40790
Tokaido	40698
Toshiba	40503, 40695, 41045, 41154
Trans Continens	40826
TRANS-continents	40826, 40831, 40872
Transonic	40672, 40730, 41165
Tredex	40800, 40803, 40804
Trio	40770, 40784
TYT	40705
Umax	40690
United	40672, 40695, 40768, 40826, 40852, 41115, 41165
Universal Multimedia	40768
Universum	40591, 40713, 40741, 40869
Urban Concepts	40503
US Logic	40839
V	41064
Venturer	40790
Vestel	40713
Vieta	40705
VInc	41064, 41226
Vizio	41064, 41226
Vocopro	41027
Voxson	40690, 40730, 40774, 40831
Walkvision	40717
Welkin	40831
Wellington	40713
Wesder	40699
Wharfedale	40698, 40752, 40768, 40790
Wilson	40831
Windsor	40713
Windy Sam	40573
WIZE	41115

Xbox	40522
Xenius	40651, 40790
XLogic	40768, 40798
XMS	40770
Xoro	41173, 41250
Yakumo	41004, 41056
Yamada	40872, 41004, 41056, 41158
Yamaha	40490, 40539, 40545, 40646
Yamakawa	40872
Yukai	40730, 41730
Zenith	40503, 40591, 40741, 40869
Zeus	40784
Zoece	41265

## DVDR

Apex Digital	41056
Aspire Digital	41168
Coby	41086
CyberHome	41129
Denon	40490
Dick Smith Electronics	41730
Digitrex	41056
DSE	41730
Funai	40675, 41334
Gateway	41073, 41158
Go Video	40741, 41158, 41304, 41730
iLo	41348
JVC	41164
LG	40741
LiteOn	41158, 41416, 41440
Loewe	40741
Magnavox	40646
Mitsubishi	41403
Mustek	41730
NEC	41404
Panasonic	40490

Philips	40646, 41158
Pioneer	40631
Polaroid	41086
RCA	40522
Samsung	40490
Sensory Science	41158
Sharp	40675
Sony	41033, 41431
Sylvania	40675
Zenith	40741

## VCR

ABS	21972
Accent	20072
Admiral	20048, 20209, 20479
Adventura	20000
Adyson	20072
Aiko	20278
Aim	20209, 20278, 20642
Aiwa	20000, 20032, 20037, 20124, 20209, 20315, 20348, 20479
Akai	20037, 20041, 20081, 20175, 20240, 20315, 20348, 20642
Akashi	20072
Akiba	20072
Akura	20072
Alba	20000, 20072, 20081, 20209, 20278, 20315, 20348
Alienware	21972
Allstar	20081
America Action	20278
American High	20035
Amoisonic	20479
Amstrad	20000, 20072, 20278
Anam	20037, 20162, 20226, 20240, 20278
Anam National	20162, 20226, 21562
Anitech	20072

Ansonic	20000
Apelsound	20209
Aristona	20081
ASA	20037, 20081
Asha	20240
Asuka	20037, 20038
Audiosonic	20072, 20278
Audiovox	20037, 20278
Awa	20037, 20043, 20278, 20642
Baird	20000, 20041, 20104
Basic Line	20046, 20072, 20104, 20278
Beaumark	20240
Beko	20104
Bell & Howell	20104
Bestar	20278
Black Diamond	20081, 20642
Black Panther	20278
Blaupunkt	20081, 20162, 20226
Blue Sky	20037, 20072, 20209, 20278, 20348, 20642
Bondstec	20072
Brandt	20041, 20320
Brandt Electronic	20041
Brandt Electronique	20041
Brinkmann	20209, 20348
Broksonic	20002, 20121, 20184, 20209, 20348, 20479, 21479
Bush	20000, 20072, 20081, 20209, 20278, 20315, 20348, 20642
Calix	20037
Canon	20035
Carena	20209
Carrefour	20045
Carver	20081
Casio	20000
Cathay	20278
CCE	20072, 20278

CGE	20000
Changhong	20048, 20081
Cimline	20072
Cineral	20278
Citizen	20037, 20278, 21278
Clatronic	20000, 20072
Colt	20072
Condor	20278
Craig	20037, 20047, 20072, 20240
Crown	20037, 20072, 20278
Curtis Mathes	20035, 20041, 20060, 20162, 21035
Cybernex	20240
CyberPower	21972
Cyrus	20081
Daewoo	20045, 20046, 20104, 20209, 20278, 20642, 21278
Dansai	20072, 20278
Daytron	20278
De Graaf	20042, 20046, 20048, 20081, 20104
Decca	20000, 20067, 20081, 20209, 20348
Deitron	20278
Dell	21972
Denko	20072
Denon	20042
Diamant	20037
Diamond	20209, 20348
Dick Smith Electronics	20642
Digitor	20642
DirecTV	20739
Domland	20209
DSE	20642
Dual	20000, 20041, 20081, 20278, 20348
Dumont	20000, 20081, 20104
Durabrand	20038, 20039
Dynatech	20000
Elbe	20038, 20278
Elcotech	20072

Electrohome	20037
Electroponic	20037
Elin	20240
Elsay	20072
Elta	20072, 20278
Emerex	20032
Emerson	20000, 20002, 20035, 20037, 20043, 20045, 20072, 20121, 20184, 20209, 20240, 20278, 20294, 20479, 21278, 21479
ESC	20240, 20278
Ferguson	20000, 20041, 20278, 20320
Fidelity	20000, 20072, 20240, 20278, 20432
Finlandia	20000, 20037, 20042, 20043, 20046, 20048, 20081, 20104, 20226
Finlux	20000, 20042, 20081, 20104, 20315
Firstline	20037, 20043, 20045, 20072, 20209, 20278, 20348
Fisher	20046, 20047, 20104
Flint	20209, 20348
Frontech	20072
Fuji	20033, 20035
Fujitsu	20000, 20045
Fujitsu General	20037
Funai	20000, 21333
Galaxis	20278
Garrard	20000
Gateway	21972
GE	20035, 20048, 20060, 20209, 20226, 20240, 20320, 20807, 21035, 21060
GEC	20081
General	20045
General Technic	20348
Genexxa	20104
Gessen	20278
Go Video	20432
GoldHand	20072

GoldStar	20037, 20038, 20209, 20225, 20226, 20348, 21237
Goodmans	20000, 20037, 20072, 20081, 20209, 20278, 20348, 20642
GPX	20037
Gradiente	20000
Graetz	20041, 20104, 20240
Granada	20000, 20037, 20042, 20046, 20048, 20081, 20104, 20226, 20240
Grandin	20000, 20037, 20072, 20209, 20278
Gronic	20104
Grundig	20072, 20081, 20226, 20320, 20347, 20348
Haaz	20348
Hanseatic	20037, 20038, 20081, 20209
Haojie	20240
Harley Davidson	20000
Harman/Kardon	20038, 20081
Harwood	20072
HCM	20072
Headquarter	20046
Hewlett Packard	21972
Hher	20278, 20642
HI-Q	20047
Hinari	20041, 20072, 20240, 20278
Hischito	20045
Hitachi	<b>*[20000]</b> , 20037, 20041, 20042, 20046, 20081, 20089, 20240, 20040
Hornyphon	20081
Howard Computers	21972
HP	21972
Hughes Network Systems	20042, 20739
Humax	20739
Hush	21972
Hypson	20000, 20037, 20072, 20209, 20278
iBUYPOWER	21972

Imperial	20000
Ingersoll	20209, 20240
Inno Hit	20072, 20432
inotech	20278
Interbuy	20072
Interfunk	20081, 20104
Internal	20278
International	20037, 20278, 20642
Intervision	20000, 20209, 20278
IR	20041, 20042, 20045, 20047, 20072, 20081, 20104, 20209, 20226, 20240, 20348
Irradio	20072, 20081
ITT	20041, 20046, 20104, 20240
ITV	20037, 20278
JBL	20278
Jensen	20041
JMB	20209, 20348
Joyce	20000
JVC	20041, 20045, 20067, 20081, 21008, 21283
Kaisui	20072
Kambrook	20037
Karcher	20081, 20278
KEC	20037, 20278
Kendo	20072, 20209, 20278, 20315, 20348, 20642
Kenwood	20038, 20041, 20067
KIC	20000
Kimari	20047
Kioto	20348
KLH	20072
Kneissel	20037, 20209, 20278, 20348
Kodak	20035, 20037
Kolin	20041, 20043
Kolster	20209
Korpel	20072

Kuba Electronic	20047
Kyoto	20072
Lenco	20278
Leyco	20072
LG	20037, 20038, 20042, 20045, 20209, 21237
Lifetec	20209, 20348
Linksys	21972
Lloyd's	20000
Loewe	20037, 20081, 20162, 21562
Logik	20072, 20209, 20240
Lux May	20072
Luxor	20043, 20046, 20047, 20048, 20104, 20315
LXI	20037
M Electronic	20000, 20038
Magnasonic	20278, 21278
Magnavox	20000, 20035, 20039, 20081, 20149, 20642, 21781
Magnin	20240
Magnum	20642
Manesth	20045, 20072, 20081, 20209
Marantz	20035, 20038, 20081, 20209
Mark	20000, 20278
Marta	20037
Mastec	20642
Master's	20278
Matsui	20209, 20240, 20278, 20348
Matsushita	20035, 20162, 20226
Media Center PC	21972
Medion	20209, 20348, 20642
MEI	20035
Melectronic	20000, 20037, 20038
Memorex	20000, 20035, 20037, 20039, 20046, 20047, 20048, 20104, 20162, 20209, 20240, 20348, 20479, 21237

Memphis	20072
Metronic	20081
Metz	20037, 20081, 20162, 20226, 20347, 21562
MGA	20043, 20240
MGN Technology	20240
Micormay	20348
Micromaxx	20209, 20348
Microsoft	21972
Mind	21972
Minolta	20042
Mitsubishi	20000, 20041, 20043, 20048, 20067, 20081, 20642, 20807
Motorola	20035, 20048
MTC	20000, 20240
Multitec	20037
Multitech	20000, 20072, 20278
Murphy	20000
Myryad	20081
NAD	20104
Naiko	20642
National	20162, 20226, 20240
Nebula Electronics	20033
NEC	20035, 20037, 20038, 20041, 20048, 20067, 20104, 20209, 20278
Neckermann	20081
Nesco	20072
Neufunk	20209
Newave	20037
Nikkai	20072, 20278
Nikko	20037
Niveus Media	21972
Noblex	20240
Nokia	20041, 20042, 20046, 20048, 20081, 20104, 20240, 20278, 20315
Nordmende	20041, 20067, 20320
Northgate	21972
Novatronic	20209

Nu-Tec	20209
Oceanic	20000, 20041, 20046, 20048, 20081, 21014
Okano	20072, 20209, 20278, 20315, 20348
Olympus	20035, 20226
Onida	20162
Onimax	20642
Onkyo	20222
Optimus	20037, 20048, 20104, 20162, 20432, 21062
Orbit	20072
Orion	20002, 20121, 20184, 20209, 20348, 20479, 21479
Osaki	20000, 20037, 20072
Osume	20072
Otake	20209
Otto Versand	20081
Pacific	20000, 20348, 20642
Packard Bell	21972
Palladium	20037, 20041, 20072, 20209, 20315, 20348
Palsonic	20000, 20037, 20072, 20642
Panasonic	20035, 20162, 20225, 20226, 20614, 20616, 21035, 21062, 21308, 21562
Pathe Cinema	20043
Pathe Marconi	20041
Penney	20035, 20037, 20038, 20042, 20240, 21035, 21237
Pentax	20042
Perdio	20000, 20209
Philco	20000, 20035, 20038, 20072, 20209, 20226, 20479
Philips	20000, 20035, 20081, 20226, 20616, 20618, 20739
Phoenix	20278
Phonola	20081
Pilot	20037

Pioneer	20042, 20067, 20081, 20162, 21562
Polk Audio	20081
Portland	20278
Prinz	20000
Profitronic	20081, 20240
Proline	20000, 20278, 20320, 20642
Proscan	20060, 21060
Prosonic	20278
Protec	20072
Protech	20081, 20278
ProVision	20278
Pulsar	20039
Pye	20000, 20081
Qisheng	20060
Quarter	20046
Quartz	20046
Quasar	20035, 20162, 20278, 21035
Quelle	20081
Radialva	20037, 20048
Radiola	20081
Radionette	20037
RadioShack	20000, 20037
Radix	20037
Randex	20037
Rank	20041
Rank Arena	20041
RCA	20000, 20035, 20042, 20048, 20060, 20149, 20226, 20240, 20320, 20432, 20807, 20880, 21035, 21060
Realistic	20000, 20035, 20037, 20046, 20047, 20048, 20104
Reoc	20348
ReplayTV	20614, 20616
Rex	20041
RFT	20072
Ricavision	21972
Roadstar	20037, 20072, 20081, 20240, 20278

Royal	20072
Runco	20039
Saba	20041, 20067, 20278, 20320
Saisho	20209, 20348
Salora	20043, 20046, 20104
Sampo	20037, 20048
Samsung	20045, 20240, 20432, 20739, 21014
Sanky	20039, 20048
Sansui	20000, 20041, 20067, 20072, 20209, 20348, 20479, 21479
Sanyo	20046, 20047, 20048, 20067, 20104, 20159, 20209, 20240, 20348, 21330
Saville	20240, 20278
SBR	20081
Schaub Lorenz	20000, 20041, 20104, 20315, 20348
Schneider	20000, 20037, 20042, 20072, 20081, 20240, 20278, 20348, 20642
Scott	20043, 20045, 20121, 20184
Sears	20000, 20035, 20037, 20042, 20046, 20047, 20104, 21237
Seaway	20278
SEG	20072, 20081, 20240, 20278, 20642
SEI	20081
Seleco	20037, 20041
Semp	20045
Sentra	20072
Serie Dorada	20037
Sharp	20037, 20048, 20209, 20807
Shinco	20000
Shintom	20072, 20104
Shivaki	20037
Shogun	20240
Siemens	20037, 20046, 20081, 20104, 20320, 20347
Siera	20081
Silva	20037
Silver	20278

Singer	20045, 20072, 20348
Sinudyne	20081, 20209
Smaragd	20348
Sonic Blue	20614, 20616
Soniko	20072
Sonitron	20104
Sonneclair	20072
Sonolor	20046
Sontec	20037
Sonwa	20642
Sony	20000, 20032, 20033, 20035, 20636, 21232, 21295, 21972
Soundwave	20037, 20209, 20348
Ssangyong	20072
Stack 9	21972
Starlite	20037
Stern	20278
STS	20042
Sunkai	20209, 20278, 20348
Sunstar	20000
Suntronic	20000
Sunwood	20072
Supra	20037, 20240, 20278, 20348
Sylvania	20000, 20035, 20043, 20081, 21781
Symphonic	20000
Systemax	21972
T+A	20162
Tagar Systems	21972
Taisho	20209
Tandberg	20278
Tandy	20000, 20104
Tashiko	20000, 20037, 20048, 20081, 20240
Tatung	20000, 20041, 20043, 20045, 20048, 20067, 20081, 20209, 20348
Tchibo	20348
TCM	20348
Teac	20000, 20037, 20041, 20072, 20278, 20642

Tec	20072
Tech Line	20072
Technics	20035, 20081, 20162, 20226
TechniSat	20209
Teco	20035, 20037, 20038, 20041, 20048
Tedalex	20037, 20209, 20348, 20642
Teknika	20000, 20035, 20037
Teleavia	20041
Telefunken	20041, 20067, 20209, 20240, 20278, 20320, 20642
Telestar	20037
Teletech	20000, 20072, 20278
Tenosal	20072
Tensai	20000, 20072, 20278
Tevion	20209, 20348, 20642
Textet	20278
Thomas	20000
Thomson	20041, 20060, 20067, 20278, 20320
Thorn	20037, 20041, 20104
Tivo	20618, 20636, 20739, 21503
TMK	20240
Tokai	20037, 20072
Topline	20348
Toshiba	20041, 20042, 20043, 20045, 20067, 20081, 20209, 20432, 20845, 21008, 21145, 21289, 21323, 21503, 21972
Totevision	20037, 20240
Touch	21972
Towada	20072
Tradex	20081
Triad	20278
Uher	20240
Ultravox	20278
Unitech	20240
United	20348
Universal	20209

Universum	20000, 20037, 20081, 20104, 20209, 20240, 20315, 20348
Vector	20045
Vector Research	20038
Victor	20041, 20067, 21283
Video Concepts	20045
Video Technic	20000
Videomagic	20037
Videosonic	20240
Viewsonic	21972
Villain	20000
Voodoo	21972
Wards	20000, 20033, 20035, 20038, 20039, 20042, 20045, 20046, 20047, 20048, 20060, 20072, 20081, 20149, 20240
Watson	20081, 20642
Wharfedale	20642
White Westinghouse	20072, 20209, 20278
World	20348
XR-1000	20000, 20035, 20072
Yamaha	20038, 20041
Yamishi	20072, 20278
Yokan	20072
Yoko	20037, 20240
Yoshita	20072
Zenith	20000, 20033, 20039, 20209, 20479, 21479
ZT Group	21972
ZX	20209, 20348
<b>TV</b>	
888	10264, 10412
A-Mark	10003
A.R. Systems	10374, 10455
Abex	10032
Accent	10009
Acura	10009



Addison	10092, 10108, 10653
Admiral	10087, 10093, 10163, 10264, 10363, 10463
Advent	10761, 10783, 10815, 10817, 10842
Adventura	10046
Adyson	10032, 10216, 10217
AEA	10037
AEG	10606
Agashi	10216, 10217
AGB	10516
Agef	10087
Aiko	10009, 10037, 10092, 10216, 10217, 10264
Aim	10045, 10208, 10264, 10339, 10374, 10412, 10455, 10606, 10706, 10753, 10805
Aiwa	10163, 10701, 10705, 10848
Akai	10009, 10030, 10035, 10037, 10060, 10072, 10163, 10178, 10191, 10208, 10216, 10217, 10218, 10264, 10361, 10363, 10371, 10377, 10412, 10433, 10473, 10480, 10516, 10548, 10556, 10581, 10602, 10606, 10631, 10648, 10672, 10696, 10698, 10702, 10706, 10714, 10715, 10729, 10745, 10753, 10812, 11537
Akashi	10009
Akiba	10037, 10218, 10282, 10455
Akira	10037, 10418, 10556
Akito	10037
Akura	10009, 10037, 10218, 10264, 10282, 10359, 10412, 10668, 10714, 11037
Alaron	10179, 10216
Alba	10009, 10036, 10037, 10163, 10216, 10218, 10235, 10247, 10355, 10371, 10418, 10443, 10487, 10581, 10668, 10714, 11037
Albatron	10700, 10843

Albiral	10102
Alfide	10672
Alkos	10035
Allorgan	10206, 10217
Allstar	10037
Ambassador	10177
America Action	10180
Amplivision	10217, 10370
Ampro	10751
Amstrad	10009, 10037, 10171, 10177, 10218, 10264, 10362, 10371, 10412, 10433, 10516, 10581, 10648, 11037
Anam	10003, 10009, 10180, 10250, 10628, 10700, 10861
Anam National	10055, 10250, 10650
Andersson	11163
Anex	10037, 10421
Anglo	10009, 10264
Anhua	10051
Anitech	10009, 10037, 10282
Ansonic	10009, 10104, 10247, 10292, 10370, 10428, 10556, 10668, 11437
AOC	10003, 10009, 10018, 10019, 10030, 10052, 10060, 10092, 10093, 10108, 10178, 10179, 10180, 10185, 10451, 10628
Aolingpu	10858
Aolinpike	10264, 10412
Apex	10156, 10765
Apex Digital	10748, 10765, 10767, 10879
Arcam	10216, 10217
Archer	10003
Ardem	10037, 10486, 10556, 10633, 10714, 10715
Aristona	10037, 10556
ART	11037
ASA	10070, 10087, 10104

Asberg	10102
Asora	10009
Astra	10037, 10264
Asuka	10217, 10218, 10264
ATD	10698
Atlantic	10001, 10206, 10320
Audinac	10180
Audiosonic	10009, 10037, 10109, 10217, 10218, 10264, 10337, 10370, 10374, 10428, 10486, 10714, 10715
Audioton	10217, 10264, 10428, 10486
Audiovox	10003, 10092, 10180, 10451, 10623, 10802, 10875
Autovox	10087, 10206, 10217, 10247, 10544
Aventura	10171
Awa	10009, 10011, 10036, 10037, 10108, 10157, 10216, 10217, 10264, 10374, 10412, 10512, 10606, 10698, 10785
Axxent	10009
Axxon	10714
Baihe	10009, 10264, 10412
Baile	10001, 10009, 10374, 10661
Baird	10072, 10073, 10193, 10208, 10217
Bang & Olufsen	10087, 10565
Baohuashi	10264, 10412
Baosheng	10009, 10817
Barco	10380
Basic Line	10009, 10037, 10217, 10218, 10282, 10339, 10374, 10455, 10556, 10668, 11037, 11163
Bauer	10805
Baur	10009, 10037, 10146, 10361, 10455, 10512, 10535, 10544
Baysonic	10180
Bazin	10217
Beaumark	10178
Beijing	10001, 10009, 10208, 10226, 10264, 10374, 10412, 10482, 10661, 10812, 10817, 10821

Beko	10037, 10292, 10370, 10418, 10428, 10486, 10606, 10714, 10715, 11037
Belcor	10019
Bell & Howell	10016, 10154
BenQ	11032, 11756
Beon	10032, 10037, 10418
Berthen	10668
Best	10337, 10370, 10421
Bestar	10037, 10370, 10374
Bestar-Daewoo	10374
Binatone	10217
Black Diamond	10556, 10587, 10614, 11037
Black Panther	10102
Black Strip	10035
Blaupunkt	10036, 10170, 10191, 10195, 10200, 10455, 10535
Blue Sky	10037, 10218, 10282, 10455, 10487, 10499, 10556, 10606, 10668, 10714, 10715, 11037, 11254, 11437
Blue Star	10282
Bondstec	10247
Boots	10009, 10217
Bosch	10320
Boxlight	10752, 10893
BPL	10037, 10208, 10282
Bradford	10180
Brandt	10109, 10287, 10335, 10560, 10625, 10714
Brandt Electronique	10335
Brinkmann	10037, 10418, 10486, 10668
Brionvega	10087, 10362
Britannia	10216, 10217
Brockwood	10019
Broksonic	10003, 10180, 10236, 10463
Bruns	10087
BTC	10218

Bush	10009, 10036, 10037, 10163, 10208, 10217, 10218, 10235, 10264, 10282, 10355, 10361, 10363, 10371, 10374, 10486, 10487, 10556, 10581, 10614, 10617, 10661, 10668, 10698, 10714, 11037
Caihong	10009, 10817
Cailing	10748
Caishi	10891
Candle	10030, 10046, 10056, 10186
Canton	10218
Carad	10037, 10610, 10668, 11037
Carena	10037, 10455
Carnivale	10030
Carrefour	10036, 10070
Carver	10054, 10170
Cascade	10009, 10037
Casio	10037, 10163
Cathay	10037
CCE	10037, 10217
Celebrity	10000
Celera	10765
Celestial	10767, 10819, 10820, 10821
Centrex	10698, 10780, 10826
Centrum	11037
Centurion	10037
Century	10087, 10238, 10247
CGE	10247, 10370, 10418
CGM	11037
Changcheng	10001, 10009, 10051, 10264, 10374, 10412, 10661, 10817
Changfei	10009, 10374, 10817
Changfeng	10264, 10412, 10696, 10753, 10817
Changhai	10009, 10817
Changhong	10009, 10156, 10264, 10508, 10765, 10767, 10783, 10817, 10820, 10821, 10848, 11156

Chengdu	10009, 10817
Ching Tai	10003, 10009, 10092, 10179
Chun Yun	10000, 10003, 10009, 10092, 10179, 10180, 10700, 10843
Chunfeng	10009, 10264
Chung Hsin	10036, 10053, 10108, 10180
Chungfeng	10412
Chunsun	10009, 10817
Cimline	10009, 10218
Cinema	10672
Cineral	10092, 10451
Citizen	10030, 10039, 10046, 10056, 10060, 10092, 10186, 10280
City	10009
Clairtone	10185
Clarion	10180
Clarivox	10037, 10070, 10337
Clatronic	10009, 10037, 10102, 10217, 10218, 10247, 10264, 10320, 10370, 10371, 10556, 10579, 10606, 10648, 10714
Clayton	11037
CMS	10216
CMS Hightec	10217
Commercial Solutions	10047, 11447
Concerto	10056
Condor	10009, 10037, 10163, 10247, 10264, 10282, 10320, 10370, 10411, 10418
Conia	10754, 10821
Conic	10032
Conrac	10808
Conrowa	10009, 10145, 10156, 10264, 10412, 10696, 10698, 10753, 11156, 11170
Contec	10009, 10036, 10037, 10157, 10180, 10185, 10216, 10264, 10698
Continental Edison	10109, 10287, 10487
Cosmel	10037, 10337
Craig	10180
Crosley	10054, 10087, 10247

Crown	10009, 10037, 10039, 10053, 10180, 10208, 10339, 10359, 10370, 10412, 10418, 10421, 10486, 10487, 10579, 10606, 10672, 10712, 10714, 10715
Crown Mustang	10672
CS Electronics	10216, 10218, 10247
CTC	10247
Curtis Mathes	10016, 10030, 10039, 10047, 10051, 10054, 10056, 10060, 10093, 10145, 10154, 10166, 10451, 10466, 10702, 11147, 11347
CXC	10180
Cybertron	10218
D-Vision	10037, 10556
D.Boss	10037
Daewoo	10003, 10009, 10019, 10030, 10032, 10037, 10039, 10056, 10092, 10108, 10154, 10170, 10178, 10180, 10217, 10218, 10264, 10374, 10451, 10499, 10556, 10623, 10628, 10634, 10661, 10672, 10700, 10706, 10865, 10880, 11661
Dainichi	10216, 10218
Dansai	10009, 10032, 10035, 10036, 10037, 10208, 10216
Dansette	10412
Dantax	10606, 10714, 10715
Datsura	10208
Dawa	10009
Daytek	10037, 10706
Dayton	10009
Daytron	10019, 10374
Dayu	10374, 10661
De Graaf	10208, 10363, 10548
DEC	10418, 10556, 10698, 10785, 10795
Decca	10037, 10072, 10217, 10516, 10621
Deitron	10037, 10374
Dell	11080, 11178, 11264, 11454

Denko	10264
Denon	10145, 10511, 10576
Denstar	10628
Denver	10037, 10587, 10606
DER	10193
Desmet	10009, 10037, 10087, 10320
Diamant	10037
Diamond	10009, 10037, 10216, 10264, 10371, 10672, 10698, 10706, 10825
Dick Smith Electronics	10698
Digatron	10037
Digiline	10105, 10668
Digital Life	10780, 10872, 10891
Digitex	10820
Digitor	10037, 10499, 10698, 11724
Digix	10880
DiK	10037
Dixi	10009, 10037, 10087
DL	10037, 10780, 10848, 10872, 10891
Domeos	10037, 10668, 11037
Domland	10394
Dongda	10009
Donghai	10009
Dream Vision	11704
DSE	10698
Dual	10037, 10217, 10259, 10394, 10531, 10544, 11137
Dual Tec	10217
Dumont	10017, 10019, 10070, 10087, 10102
Dunai	10544
Durabrand	10003, 10171, 10178, 10180, 10463, 11034, 11463
DVX	10891
Dwin	10720, 10774
Dynatron	10012, 10037
E-Elite	10218

Ecco	10706, 10773
ECE	10037
Edison-Minerva	10487
Elbe	10217, 10238, 10259, 10292, 10361, 10362, 10411, 10435, 10516, 10610, 10630
Elbe-Sharp	10516
Electroband	10000, 10185
Electrograph	11755
Electrohome	10381
Elekta	10009, 10037, 10264, 10282
Elektra	10017, 11661
Elin	10009, 10037, 10104, 10163, 10361, 10548
Elite	10218, 10320
Elman	10102
Elta	10009, 10264
Emco	10247
Emerson	10019, 10037, 10038, 10039, 10070, 10087, 10154, 10163, 10171, 10177, 10178, 10179, 10180, 10185, 10236, 10247, 10280, 10282, 10320, 10361, 10370, 10371, 10463, 10486, 10623, 10714
Emperor	10282
Envision	10030, 10813
Enzer	10753
Epson	10833, 10840
Erres	10012, 10037
ESA	10171, 10812
ESC	10037, 10217
Ether	10003, 10009, 10030
Etron	10001, 10009
Eurofeel	10217, 10264
EuroLine	10556
Euroman	10037, 10216, 10217, 10264, 10421
Europa	10037

Europhon	10102, 10163, 10217, 10516
Evolution	11756
Expert	10206
Exquisit	10037, 10247
Fagor	10037
Feilang	10009
Feilu	10009, 10817
Feiyan	10264, 10412
Feiyue	10009, 10817
Fenner	10009, 10374
Ferguson	10037, 10053, 10073, 10109, 10193, 10238, 10287, 10335, 10443, 10548, 10560, 10625
Fidelity	10037, 10163, 10171, 10193, 10216, 10264, 10361, 10363, 10371, 10412, 10512, 10531, 10544
Filsai	10217
Finlandia	10045, 10072, 10163, 10208, 10287, 10346, 10359, 10363, 10548
Finlux	10037, 10070, 10072, 10087, 10102, 10104, 10105, 10179, 10217, 10346, 10411, 10473, 10480, 10492, 10516, 10556, 10606, 10621, 10629, 10631, 10714, 10715, 10808
Firstar	10009, 10236
Firstline	10009, 10037, 10072, 10163, 10208, 10216, 10217, 10235, 10238, 10247, 10321, 10361, 10374, 10411, 10531, 10544, 10556, 10587, 10668, 10714, 10808, 11037
Fisher	10036, 10045, 10047, 10072, 10087, 10104, 10154, 10157, 10159, 10208, 10217, 10370, 10544, 10555
Flint	10037, 10072, 10218, 10264, 10455, 10610
Forgestone	10193
Formenti	10037, 10087, 10216, 10320
Formenti-Phoenix	10216, 10320

Fortress	10093
Fraba	10037, 10370
Friac	10009, 10037, 10102, 10370, 10421, 10499, 10610
Frontech	10009, 10163, 10217, 10247, 10264, 10363
Fujitsu	10009, 10037, 10072, 10163, 10179, 10186, 10206, 10217, 10259, 10361, 10683, 10809, 10853
Fujitsu General	10009, 10163, 10206, 10217, 10683
Funai	10171, 10179, 10180, 10264, 10412, 10556, 10668, 11977
Furi	10145, 10264, 10412, 10817
Futronic	10264, 10795
Future	10037
Futuretech	10180
Galaxi	10037, 10361
Galaxis	10037, 10370
Ganxin	10817
Gateway	11755, 11756
GBC	10009, 10218, 10374
GE	10021, 10027, 10030, 10047, 10051, 10055, 10092, 10093, 10109, 10135, 10178, 10180, 10282, 10287, 10335, 10451, 10560, 10625, 11147, 11347, 11447, 11454
GEC	10037, 10072, 10163, 10217, 10361, 10516
Geloso	10009, 10363, 10374
General	10186, 10590
General Technic	10009
Genesis	10009, 10037
Genexxa	10009, 10163, 10218
Gericom	10808, 10865
Giant	10217
Gibraltar	10017, 10019, 10030
Gintai	10721

Go Video	10886
Goldfunk	10668
GoldHand	10216
GoldStar	10001, 10019, 10030, 10032, 10037, 10039, 10056, 10109, 10154, 10163, 10178, 10216, 10217, 10247, 10290, 10361, 10363, 10377, 10455, 10556, 10606, 10714, 10715
Gooding	10487
Goodmans	10009, 10032, 10035, 10036, 10037, 10072, 10179, 10217, 10218, 10235, 10264, 10335, 10360, 10371, 10374, 10451, 10480, 10487, 10499, 10516, 10556, 10560, 10579, 10630, 10634, 10661, 10668, 10714, 10808, 11037, 11163
Gorenje	10037, 10370, 10421
GPM	10218
Gradiente	10053, 10056, 10170
Graetz	10037, 10163, 10339, 10361, 10371, 10487, 10714
Gran Prix	10648
Granada	10037, 10045, 10072, 10108, 10146, 10163, 10208, 10217, 10226, 10339, 10356, 10359, 10363, 10473, 10516, 10548, 10560
Grandin	10009, 10037, 10163, 10282, 10320, 10374, 10455, 10579, 10610, 10668, 10714, 10715, 11037
Gronic	10163
Grundig	10036, 10037, 10070, 10191, 10195, 10370, 10443, 10487, 10535, 10556, 10587, 10630, 10672, 10706
Grunpy	10179, 10180
H&B	10808
Haaz	10706
Haier	10037, 10264, 10508, 10587, 10698, 10768, 10779, 10869, 10891, 11034

Haihong	10009
Haiyan	10264, 10412, 10817
Halifax	10217
Hallmark	10178
Hammerstein	10060, 10264
Hampton	10216, 10217
Hanimex	10218
Hankook	10019, 10030, 10056, 10178, 10180, 10628
Hanseatic	10009, 10037, 10087, 10195, 10217, 10282, 10320, 10361, 10377, 10394, 10428, 10499, 10544, 10556, 10634, 10661, 10714, 10808, 11137
Hantarex	10009, 10037, 10102, 10238, 10516, 10865
Hantor	10037
Harley Davidson	10179
Harman/Kardon	10054
Harsper	10865
Harvard	10180
Harwa	10773
Harwood	10009, 10032, 10037, 10412, 10487
Havermy	10093
HCM	10009, 10037, 10217, 10218, 10264, 10282, 10412, 10418, 10606
Helios	10865
Hello Kitty	10451
Hema	10009, 10217
Hemmermann	10544
Hher	10714
Higashi	10216
Hikona	10218
Himitsu	10180, 10628, 10779
Hinari	10009, 10036, 10037, 10179, 10218, 10235, 10264, 10355
Hisawa	10218, 10282, 10455, 10610, 10714

Hisense	10009, 10037, 10145, 10156, 10208, 10264, 10508, 10512, 10556, 10696, 10706, 10748, 10753, 10780, 10821, 10848, 11156, 11170
Hit	10087
Hitachi	10009, 10016, 10019, 10027, 10030, 10032, 10036, 10037, 10038, 10039, 10044, 10056, 10072, 10092, 10105, 10108, 10109, 10145, 10151, 10156, 10157, 10163, 10165, 10178, 10179, 10186, 10194, 10217, 10356, 10359, 10361, 10363, 10381, 10473, 10480, 10481, 10492, 10499, 10508, 10512, 10516, 10548, 10576, 10578, 10629, 10634, 10719, 10744, 10884, 11037, 11045, 11137, <b>*[11145]</b> , 11156, 11170, 11225, 11256, 11481, 11576
Hitachi Fujian	10037, 10108, 10145, 10150, 10499, 10828
Hitsu	10009, 10218, 10455, 10610
HMV	10087, 10193
Home Electronics	10606
Hongmei	10009, 10093, 10264, 10817, 10848
Hongyan	10264, 10412, 10817
Hornophon	10012, 10037
Hoshai	10282
Hua Tun	10009
Huafa	10009, 10145
Huanghaimei	10009
Huanghe	10009, 10817
Huanglong	10009
Huangshan	10009, 10264, 10412, 10817
Huanyu	10216, 10264, 10374, 10817, 10848
Huaqiang	10264, 10412
Huari	10145, 10264, 10412
Huodateji	10051
Hyper	10009, 10216, 10217, 10247

Hypson	10037, 10264, 10282, 10411, 10455, 10621, 10668, 10714, 10715, 11037
Hyundai	10037, 10698, 10706, 10753, 10849, 10865
Iberia	10037
ICE	10216, 10217, 10218, 10264, 10371, 10556
ICeS	10216, 10218
Imperial	10037, 10163, 10247, 10361, 10370, 10418, 10630
Imperial Crown	10001, 10009, 10264, 10374, 10412, 10661
Indiana	10037
Infinity	10054
InFocus	10752
Ingelen	10163, 10361, 10487, 10610, 10714
Ingersoll	10009
Inno Hit	10009, 10037, 10072, 10102, 10217, 10247, 10282, 10290, 10516
Innova	10037
Innowert	10865
Inteq	10017
Interbuy	10037, 10247, 10264, 10512
Interfunk	10012, 10037, 10087, 10163, 10200, 10247, 10275, 10361, 10512
Internal	10037
Intervision	10009, 10037, 10102, 10163, 10217, 10218, 10247, 10264, 10282, 10370, 10377, 10394, 10455, 10486, 10487
IR	10011, 10012, 10032, 10035, 10036, 10037, 10045, 10070, 10072, 10073, 10087, 10093, 10102, 10104, 10105, 10108, 10109, 10146, 10157, 10163, 10191, 10193, 10194, 10195, 10200, 10206, 10216, 10217, 10226, 10235, 10238, 10247, 10287, 10290, 10291, 10292, 10320, 10356, 10359, 10361, 10363, 10370, 10374, 10512, 10516, 10535, 10556

Irradio	10218, 10247, 10290, 10371	Kambrook	10217, 10264, 10556	Konka	10037, 10218, 10282, 10371, 10418, 10587, 10628, 10632, 10638, 10641, 10703, 10707, 10714, 10725, 10726, 10754, 10779, 10795, 10816, 10817
IRT	10451, 10628, 10698, 11661	Kamp	10216	Kontakt	10487
Isukai	10037, 10218, 10282, 10455	Kangchong	10848	Korpel	10037
ITC	10217, 10320	Kangli	10001, 10009, 10264, 10374, 10661, 10817	Korting	10087, 10320, 10421
ITS	10216, 10264, 10371	Kangyi	10009, 10264, 10412	Kotron	10264
ITT	10163, 10179, 10193, 10208, 10339, 10346, 10361, 10473, 10480, 10544, 10548, 10610	Kapsch	10104, 10163, 10206, 10361	Koyoda	10009
ITT Nokia	10163, 10179, 10208, 10339, 10346, 10361, 10363, 10473, 10480, 10548, 10606, 10610	Karcher	10037, 10163, 10264, 10282, 10421, 10606, 10610, 10714	Kraking	10238
ITV	10037, 10264, 10374	Kathrein	10556	Kriesler	10012
Janeil	10046	Kawa	10371	KTV	10030, 10039, 10180, 10185, 10217, 10280
JBL	10054	Kawasho	10216	Kuaile	10009, 10264, 10412
JCB	10000	Kaypani	10052	Kulun	10009
Jean	10003, 10009, 10036, 10051, 10092, 10156, 10179, 10236, 10721	KB Aristocrat	10163	Kunlun	10051, 10208, 10226, 10264, 10374, 10661, 10817
Jensen	10698, 10706, 10761, 10815, 10817	KEC	10180	Kyoshu	10032, 10264, 10412, 10418
Jiahua	10051	Kendo	10037, 10102, 10235, 10247, 10362, 10411, 10428, 10512, 10610, 11437	Kyoto	10032, 10163, 10216, 10217
JiaLiCai	10009, 10264, 10412	Kennedy	10206, 10435	L&S Electronic	10714, 10808
Jinfeng	10051, 10208, 10226, 10817	Kennex	11037	LaSAT	10486
Jinhai	10848	Kenwood	10019, 10030	Leader	10009
Jinque	10009, 10264, 10412, 10817	KIC	10217	Lecson	10037
Jinta	10009, 10264, 10412, 10848	Kingsley	10216	Legend	10009
Jinxing	10009, 10037, 10054, 10145, 10156, 10264, 10556, 10698, 10817, 10821	Kiota	10001, 10371, 10455	Lemair	10032, 10411
JMB	10443, 10499, 10556, 10634	Kioto	10054, 10556, 10706, 10785	Lenco	10037, 10163, 10374, 10721, 11037
JNL	10698	Kiton	10037, 10668	Levis Austria	10037
Jocel	10712	KLH	10765, 10767	Leyco	10037, 10072, 10264, 10579
Jubilee	10556	KLL	10037	LG	10001, 10003, 10019, 10030, 10032, 10037, 10038, 10039, 10056, 10060, 10108, 10178, 10442, 10556, 10606, 10644, 10698, 10700, 10714, 10715, 10856, 11148, 11178, 11265, 11637, 10033
Juhua	10264, 10412, 10817	Kloss	10024, 10046	Liesen & Tter	10037
JVC	10036, 10053, 10093, 10193, 10218, 10371, 10418, 10463, 10508, 10576, 10606, 10653, 10683, 10731, 11253	Kneissel	10037, 10238, 10259, 10292, 10362, 10374, 10411, 10435, 10499, 10556, 10610	Liesenkotter	10012, 10037
Kaige	10009, 10264, 10412, 10817	Kolin	10036, 10053, 10108, 10150, 10180	Lifetec	10037, 10218, 10264, 10374, 10668, 10714, 11037, 11137, 11437
Kaisui	10009, 10037, 10216, 10217, 10218, 10282, 10455	Kolster	10102, 10247		
		Kongque	10009, 10264, 10817		
		Konichi	10009		

Lihua	10817
Lloyd's	10001, 10009, 10264
Lloytron	10032
Loewe	10037, 10087, 10136, 10292, 10362, 10512, 10516, 10633, 10655
Logik	10001, 10009, 10011, 10016, 10060, 10193, 10264, 10418, 10698, 10706, 10773, 10880
Logix	10668
Longjiang	10264, 10412, 10817
Luma	10206, 10259, 10362, 10363, 11037
Lumatron	10217, 10361
Lux May	10009, 10037, 10556, 10581
Luxman	10056, 10412, 10579
Luxor	10163, 10179, 10194, 10208, 10217, 10290, 10356, 10361, 10363, 10473, 10480, 10548, 10631, 11037, 11163
LXI	10047, 10054, 10154, 10156, 10178
M & S	10054
M Electronic	10009, 10037, 10104, 10105, 10109, 10163, 10217, 10287, 10346, 10374, 10480
Madison	10037
Magnadyne	10087, 10102, 10247, 10516, 10544
Magnafon	10102, 10216, 10516
Magnavox	10020, 10024, 10030, 10036, 10037, 10054, 10096, 10179, 10186, 10187, 10386, 10706, 10729, 10780, 10802, 11254, 11454
Magnum	10037, 10606, 10648, 10714, 10715
Majestic	10016
Manesth	10035, 10037, 10163, 10217, 10235, 10264, 10320, 10361
Manhattan	10037, 10163, 10668, 11037
Marantz	10030, 10037, 10054, 10412, 10556, 10704, 10854, 10855, 11154
Marelli	10087

Mark	10037, 10217, 10486, 10714, 10715
Master's	10499
Masuda	10009, 10037, 10217, 10218, 10264, 10371
Materin	10208, 10858
Matsui	10009, 10011, 10035, 10036, 10037, 10072, 10163, 10177, 10191, 10195, 10208, 10217, 10235, 10335, 10355, 10363, 10371, 10433, 10443, 10455, 10487, 10516, 10544, 10556, 10579, 10629, 10714, 11037
Matsushita	10051, 10250, 10650
Matsuviana	10587
Maxam	10264
Maxdorf	10773
Maxent	11755
MCE	10009
Mediator	10012, 10037
Medion	10037, 10512, 10556, 10668, 10698, 10714, 10808, 10880, 11037, 11137, 11437
Megapower	10700
Megas	10610
Megatron	10003, 10145, 10178
MEI	10185, 11037
Meile	10264, 10412, 10817, 10848
Melectronic	10009, 10037, 10104, 10105, 10163, 10191, 10195, 10216, 10217, 10247, 10346, 10361, 10374, 10411, 10480, 10492, 10512, 10634, 10661, 10714
Memorex	10009, 10016, 10056, 10060, 10150, 10154, 10178, 10179, 10250, 10463, 11037
Memphis	10337
Mercury	10001, 10009, 10060, 10264, 10473, 10556, 10706
Mermaid	10037

Merritt	10163
Metronic	10625
Metz	10037, 10070, 10087, 10275, 10367, 10388, 10447, 10535, 10587, 10668, 10746
MGA	10019, 10030, 10037, 10150, 10178, 10218, 10374
Micromaxx	10037, 10630, 10668, 10808, 11037
Microstar	10808
MicroTEK	10706
Midland	10017, 10032, 10039, 10047, 10051, 10135
Minato	10037
Minerva	10070, 10108, 10487, 10516, 10535
Minoka	10359, 10412
Minutz	10021
Mistral Electronics	10193
Mitsubishi	10019, 10030, 10036, 10037, 10056, 10087, 10093, 10108, 10150, 10154, 10178, 10179, 10180, 10208, 10236, 10250, 10381, 10512, 10535, 10556, 10817, 10836, 10868, 11037, 11250
Mitsuri General	10163
Mivar	10216, 10217, 10290, 10291, 10292, 10370, 10516, 10609
Monaco	10009
Monivision	10700, 10843
Morgan's	10037
Motorola	10055, 10093
MTC	10019, 10030, 10056, 10060, 10163, 10185, 10216, 10361, 10370, 10512
MTEC	10032
MTlogic	10714
Mudan	10009, 10051, 10208, 10226, 10264, 10412, 10817
Multibroadcast	10193
Multitec	10037, 10486, 10668, 11037

Multitech	10009, 10037, 10102, 10180, 10216, 10217, 10247, 10264, 10363, 10486, 10556
Murphy	10039, 10163, 10216
Musikland	10037, 10218, 10247
Myryad	10556
NAD	10156, 10178, 10361, 10866
Naiko	10037, 10606
Nanbao	10009, 10264, 10412, 10848
Nansheng	10264, 10412, 10817
Naonis	10363
NAT	10226
National	10051, 10055, 10208, 10226, 10508
NEC	10009, 10011, 10019, 10030, 10036, 10046, 10051, 10053, 10056, 10154, 10156, 10165, 10170, 10178, 10186, 10217, 10264, 10320, 10374, 10381, 10412, 10455, 10497, 10499, 10508, 10603, 10661, 10704, 10705, 10817, 10882, 11170, 11270, 11704
Neckermann	10037, 10087, 10163, 10191, 10200, 10247, 10320, 10363, 10370, 10411, 10418, 10512, 10556
NEI	10037, 10163, 10287, 10337, 10371
Neovia	10865
Nesco	10179, 10247
Netsat	10037
NetTV	11755
Network	10032, 10337
Neufunk	10037, 10218, 10556, 10610, 10714
New Tech	10217
Newave	10009, 10092, 10093, 10178, 10721
Nicam	10544
Nicamagic	10216
Nikkai	10009, 10032, 10035, 10036, 10037, 10072, 10216, 10217, 10218, 10264, 10337
Nikko	10030, 10092, 10178
Nikon	10848
Noblex	10154, 10180
Nobliko	10070, 10102, 10216
Nokia	10109, 10163, 10179, 10208, 10320, 10339, 10346, 10359, 10361, 10374, 10473, 10480, 10548, 10606, 10610, 10631
Norcent	10748, 10824
Nordic	10217
Nordmende	10037, 10109, 10163, 10195, 10287, 10335, 10560, 10714
Norfolk	10163
Normerel	10037
Noshi	10018
Novak	10012, 10037
Novatronic	10037, 10105, 10374, 10531
NTC	10092
Nu-Tec	10037, 10455, 10698, 10706, 10820
Oceanic	10163, 10208, 10361, 10473, 10548
Okano	10009, 10037, 10370
Omega	10264
Omni	10264, 10698, 10706, 10780, 10826, 10872, 10891
On Command	10531
Onimax	10714
Onking	10280
Onwa	10102, 10180, 10218, 10371, 10433, 10581, 10602
Optimus	10154, 10166, 10250, 10650
Optoma	10887
Optonica	10093, 10165
Orion	10011, 10037, 10177, 10179, 10235, 10236, 10264, 10320, 10321, 10355, 10412, 10443, 10463, 10516, 10531, 10544, 10556, 10606, 10655, 10714, 10880, 11463
Orline	10037, 10218
Ormond	10668, 11037
Orsowe	10516
Osaki	10032, 10037, 10072, 10217, 10218, 10264, 10355, 10374, 10412, 10556
Osio	10290
Oso	10218
Osume	10032, 10036, 10037, 10072, 10157, 10218
Otto Versand	10036, 10037, 10093, 10109, 10191, 10217, 10226, 10235, 10247, 10320, 10361, 10512, 10535, 10544, 10556
Pacific	10037, 10556, 10714, 11037, 11137
Pael	10216
Palladium	10037, 10247, 10363, 10370, 10411, 10418, 10630, 10655, 10714, 11137
Palsonic	10001, 10037, 10217, 10218, 10264, 10377, 10412, 10418, 10698, 10773, 10779
Panama	10037, 10217, 10247, 10264
Panashiba	10001
Panasonic	10037, 10051, 10054, 10055, 10108, 10163, 10208, 10226, 10250, 10361, 10367, 10508, 10516, 10548, 10650, 10853, 11310, 11410, 11650
Panavision	10037, 10411
Panda	10009, 10051, 10208, 10226, 10264, 10412, 10508, 10698, 10706, 10780, 10817, 10821, 10826, 10848, 10891
Pathe Cinema	10163, 10216, 10238, 10320, 10370
Pausa	10009
Peng Sheng	10891
Penney	10003, 10018, 10019, 10021, 10027, 10030, 10032, 10039, 10047, 10051, 10056, 10060, 10135, 10156, 10178, 11347
Perdio	10037, 10072, 10163, 10216, 10282, 10320



Phase	10032	Prinston	11037	Radiotone	10009, 10037, 10264, 10412, 10428, 10579, 10648, 10668, 11037
Philco	10019, 10020, 10030, 10032, 10037, 10054, 10056, 10087, 10092, 10096, 10145, 10178, 10180, 10186, 10247, 10370, 10418, 10451, 10463, 10628, 10774, 11661	Prinz	10194, 10361, 10544	Rank Arena	10036, 10157, 10602, 10753
Philex	10193, 10548	Prism	10051	RBM	10070
Philips	10000, 10009, 10012, 10017, 10019, 10020, 10024, 10027, 10030, 10032, 10037, 10051, 10054, 10056, 10080, 10087, 10092, 10108, 10178, 10186, 10187, 10191, 10193, 10200, 10238, 10361, 10374, 10423, 10556, 10690, 10721, 10772, 10774, 11154, 11454, 11756	Profex	10009, 10163, 10361, 10363, 10370	RCA	10000, 10018, 10019, 10030, 10038, 10047, 10051, 10060, 10090, 10092, 10093, 10135, 10178, 10560, 10618, 10625, 10679, 10753, 11047, 11147, 11247, 11347, 11447, 11454, 11547
Phoenix	10037, 10087, 10216, 10320, 10486	Profex Fidelity	10102	Realistic	10019, 10030, 10032, 10039, 10056, 10154, 10165, 10178, 10180
Phonola	10012, 10037, 10080, 10087, 10193, 10216	Profi	10009	Recor	10037, 10264, 10418
Pilot	10019, 10030, 10037, 10039, 10706, 10712	Profitronic	10037, 10102	Rediffusion	10036, 10346, 10361, 10548
Pioneer	10011, 10037, 10038, 10109, 10163, 10166, 10170, 10287, 10361, 10423, 10428, 10486, 10512, 10679, 10760, 10866	Proline	10037, 10072, 10321, 10411, 10556, 10621, 10625, 10630, 10634	Reflex	10037, 10668, 11037
Pionier	10486	Proscan	10047, 11347, 11447	Relisys	10865
Plantron	10009	Prosonic	10037, 10217, 10451, 10579, 10668, 10714	Reoc	10714
Playsonic	10037, 10217, 10339, 10714, 10715	Protech	10009, 10037, 10102, 10163, 10180, 10217, 10247, 10264, 10337, 10418, 10486, 10668, 11037	Revox	10037
Polaroid	10765, 10865	Proton	10001, 10003, 10009, 10030, 10039, 10052, 10056, 10178, 10466, 10644	Rex	10163, 10206, 10259, 10264, 10363, 10411
Polytron	10282, 10697	ProVision	10037, 10556, 10714	RFT	10037, 10072, 10087, 10264, 10370, 10428
Polyvision	10697	Pulsar	10017, 10019	Rhapsody	10185, 10216
Portland	10019, 10039, 10092, 10374	Pye	10012, 10037, 10087, 10193, 10374, 10412, 10556	Ricoh	10037
Powerpoint	10037, 10487	Qingdao	10051, 10208, 10226, 10264, 10412, 10817	Rinex	10264, 10418, 10698, 10773
Prandoni-Prince	10361, 10363, 10516	Quadral	10218, 10418	Roadstar	10009, 10037, 10218, 10264, 10282, 10418, 10668, 10714, 11037
Premier	10037, 10264	Qualcraft	10039	Robotron	10087
Prima	10009, 10264, 10412, 10761, 10783, 10815, 10817	Quasar	10009, 10051, 10055, 10165, 10247, 10250, 10650, 10865	Rover	10036
Princess	10698	Quelle	10011, 10037, 10070, 10104, 10200, 10361, 10512, 10535, 10544, 10668, 11037	Rowa	10009, 10037, 10216, 10217, 10264, 10556, 10587, 10698, 10712, 10748, 10817
Princeton	10700, 10717	Questa	10032, 10036	Rownsonic	10163
		R-Line	10037, 10163	Royal	10418, 10825
		Radialva	10218, 10337	Royal Lux	10335, 10412
		Radiola	10012, 10037, 10217, 10556	Runco	10017, 10030, 10497, 10603
		Radiomarelli	10037, 10087, 10516	Ruyi	10817
		RadioShack	10019, 10030, 10032, 10037, 10039, 10047, 10056, 10154, 10165, 10178, 10180	Saba	10087, 10109, 10163, 10250, 10287, 10335, 10361, 10498, 10516, 10548, 10560, 10625, 10714

Saccs	10238
Sagem	10455, 10610
Saige	10009, 10817
Saisho	10009, 10011, 10177, 10217, 10235, 10264, 10374, 10516, 10544, 10556
Saivod	10037, 10668, 10712, 11037
Saka	10163
Sakyno	10455
Salora	10163, 10194, 10208, 10290, 10356, 10359, 10361, 10363, 10473, 10480, 10516, 10548, 10606, 10621, 10631
Salsa	10335
Sambers	10102, 10516
Sampo	10009, 10030, 10032, 10036, 10039, 10052, 10092, 10093, 10154, 10171, 10178, 10650, 10700, 10721, 11755
Samsung	10009, 10019, 10030, 10032, 10037, 10039, 10056, 10060, 10072, 10090, 10092, 10093, 10154, 10156, 10163, 10178, 10179, 10195, 10208, 10216, 10217, 10226, 10264, 10290, 10370, 10482, 10556, 10587, 10618, 10644, 10682, 10702, 10718, 10766, 10774, 10812, 10814, 10817, 10821, 11060
Samsux	10039
Sandra	10216, 10217
Sanjian	10264, 10412
Sansei	10451
Sansui	10037, 10264, 10371, 10412, 10455, 10463, 10587, 10602, 10655, 10698, 10706, 10714, 10727, 10729, 10861, 11537
Santon	10009

Sanyo	10011, 10036, 10045, 10072, 10088, 10104, 10108, 10145, 10146, 10154, 10156, 10157, 10159, 10180, 10208, 10216, 10217, 10264, 10280, 10339, 10370, 10381, 10412, 10486, 10508, 10544, 10555, 10556, 10721, 10799, 10893, 11154
Sanyuan	10009, 10093, 10817
SBR	10012, 10037, 10193, 10556
Schaub Lorenz	10037, 10361, 10374, 10486, 10548, 10606, 10714
Schneider	10012, 10037, 10070, 10163, 10217, 10218, 10247, 10259, 10361, 10371, 10394, 10544, 10556, 10648, 10668, 10714, 11037, 11137
Scimitsu	10019
Scotch	10178
Scotland	10163
Scott	10019, 10178, 10179, 10180, 10236
Sears	10047, 10054, 10056, 10146, 10154, 10156, 10159, 10171, 10178, 10179
Seaway	10556, 10634
Seelver	11037
SEG	10009, 10036, 10037, 10102, 10163, 10216, 10217, 10218, 10264, 10362, 10487, 10634, 10668, 11037, 11163, 11437
SEI	10087, 10102, 10177, 10206, 10516, 10544
Sei-Sinudyne	10037, 10087, 10102, 10206, 10516, 10544
Seleco	10163, 10206, 10259, 10264, 10346, 10362, 10363, 10371, 10411, 10435
Semivox	10180
Semp	10156, 11356
Sencora	10009
Sentra	10035

Serino	10093, 10455, 10610
Shancha	10264, 10412, 10817
Shanghai	10009, 10208, 10226, 10264, 10412, 10817, 10848
Shaofeng	10145, 10817
Sharp	10009, 10030, 10032, 10036, 10039, 10053, 10093, 10157, 10165, 10193, 10200, 10256, 10386, 10491, 10516, 10650, 10688, 10689, 10720, 10818, 10851, 11193
Shen Ying	10003, 10009, 10092, 10179
Shencai	10009, 10145, 10264, 10412
Sheng Chia	10009, 10093, 10179, 10236
Shenyang	10009, 10264, 10696, 10753, 10817
Sherwood	10009
Shintoshi	10037
Shivaki	10037, 10178, 10374, 10443, 10451
Shogun	10019
Shorai	10179
Show	10009, 10072, 10418, 10706
Siarem	10087, 10102, 10516
Siemens	10032, 10037, 10146, 10157, 10191, 10195, 10200, 10361, 10535
Siera	10012
Siesta	10370
Signature	10016
Silva	10037, 10216, 10361, 10648
Silva Schneider	10037
Silver	10036, 10037, 10179, 10361, 10455, 10715
SilverCrest	11037
Simpson	10186, 10187
Singer	10009, 10087, 10102, 10163, 10335, 10362, 10371, 10433, 10435, 10548, 10698, 10706, 11537
Sinotec	10264, 10418, 10706, 10773
Sinudyne	10087, 10102, 10177, 10206, 10235, 10516, 10544

Skantic	10356
SKY	10037, 10282
Skygiant	10180
Skysonic	10696, 10753
Skyworth	10009, 10037, 10264, 10696, 10698, 10727, 10748, 10753, 10805, 10817, 10825
Sliding	10865
SLX	10512, 10668
Smaragd	10487
Soemtron	10865
Solavox	10032, 10037, 10072, 10163, 10361, 10548
Sole	10813
Sonawa	10218
Songba	10009
Soniko	10037
Sonitron	10208, 10217, 10339, 10370
Sonoko	10009, 10037, 10282
Sonolor	10163, 10208, 10282, 10361, 10548
Sontec	10009, 10037, 10370
Sony	10000, 10011, 10036, 10037, 10053, 10080, 10093, 10102, 10111, 10145, 10150, 10156, 10157, 10170, 10250, 10353, 10650, 10834, 11100, 11505, 11651
Sound & Vision	10102, 10374
Soundesign	10178, 10179, 10180, 10186
Soundwave	10032, 10037, 10320, 10418, 10715
Sowa	10036, 10051, 10060, 10092, 10156, 10178, 10226
Spectra	10009
Spectricon	10003
Squareview	10171
Ssangyong	10009, 10032
SSS	10019, 10180
Stag	10032
Staksonic	10009

Standard	10009, 10037, 10217, 10218, 10320, 10374, 11037
Starlite	10009, 10037, 10180, 10264
Stenway	10218, 10282
Stern	10163, 10206, 10259, 10363, 10411
Strato	10009, 10037, 10264
Studio Experience	10843
Sunic Line	10037
Sunkai	10037, 10321, 10355, 10455, 10487, 10531, 10610
Sunstar	10009, 10037, 10264, 10371, 10579
Sunwood	10037
Superla	10516
Superscan	10864
Supersonic	10009, 10037, 10208, 10264, 10455, 10698, 10805
SuperTech	10009, 10037, 10216, 10218
Supervision	10264
Supra	10009, 10039, 10056, 10178
Supre-Macy	10046
Supreme	10000
Susumu	10218, 10287, 10335
SVA	10587, 10698, 10748, 10768, 10865, 10870, 10871, 10872
Svasa	10455
Swissline	10247
Sylvania	10020, 10030, 10054, 10096, 10171, 10381
Symphonic	10171, 10180
Synco	10000, 10036, 10060, 10092, 10093, 10178, 10451
Sysline	10037
Sytong	10216
T+A	10447
Tacico	10009, 10092, 10178, 10179
Tai Yi	10009
Taishan	10009, 10374, 10817

Tandberg	10362, 10367, 10411
Tandy	10039, 10072, 10093, 10163, 10217, 10218
Targa	10702
Tashiko	10032, 10036, 10092, 10146, 10163, 10216, 10217, 10359, 10363, 10650, 10721
Tatung	10003, 10009, 10011, 10036, 10037, 10051, 10054, 10055, 10060, 10072, 10154, 10156, 10217, 10516, 10556, 10621, 10629, 11156, 11254, 11756
TCL	10412, 10698, 10706, 10727, 10826, 11537
TCM	10714, 10808
Teac	10009, 10037, 10170, 10171, 10178, 10217, 10247, 10264, 10282, 10412, 10418, 10455, 10512, 10544, 10556, 10668, 10698, 10706, 10712, 10714, 10721, 10755, 11037, 11437, 11724, 11755
Tec	10009, 10037, 10163, 10217, 10247, 10259, 10337, 10361
Tech Line	10037, 10668, 11437
Techica	10218
Technema	10320
Technics	10051, 10250, 10556, 10650
TechniSat	10037, 10163, 10556, 10655
Technisson	10714
Technol Ace	10179, 10264, 10374, 10412
Technosonic	10556
Techview	10847
Techwood	10003, 10051, 10056, 11163
Tecnimagen	10556
Teco	10009, 10036, 10051, 10092, 10093, 10178, 10218, 10264, 10280, 10653
Tedexlex	10009, 10037, 10208, 10217, 10264, 10418, 10556, 10606, 10706, 10726, 10891, 11537

Tek	10009, 10264, 10706, 10795	Thorn-Ferguson	10073, 10193, 10238, 10499	Tsoschi	10282
Teknika	10016, 10019, 10039, 10054, 10056, 10060, 10092, 10150, 10179, 10180, 10186	Tiane	10093, 10817	Tuntex	10009, 10030, 10092
Telecor	10037, 10394	TMK	10056, 10177, 10178	TVS	10463
Telefunken	10037, 10056, 10073, 10109, 10287, 10335, 10346, 10421, 10486, 10498, 10560, 10587, 10625, 10698, 10702, 10706, 10712, 10714, 10753, 10819, 10820, 10821	TML	11756	TVTEXT 95	10556
Telefusion	10037	TNCi	10017	Uher	10037, 10206, 10320, 10374, 10418, 10480, 10486
Telegazi	10037, 10556	Tobishi	10218	Ultravox	10037, 10087, 10102, 10216, 10247
Telemeister	10320	Tobo	10009, 10264, 10412, 10748	Unic	10163
Telesonic	10037	Tokai	10009, 10037, 10163, 10337, 10374, 10668, 11037	Unic Line	10037, 10455
Telestar	10009, 10037, 10412, 10556, 10579	Tokaido	11037	United	10037, 10606, 10714, 10715, 11037
Teletech	10009, 10037, 10337, 10668, 11037	Tokyo	10035	Universal	10027, 10037
Teleton	10036, 10163, 10186, 10206, 10217, 10259, 10363	Tomashi	10218, 10282	Universum	10009, 10011, 10032, 10036, 10037, 10070, 10104, 10105, 10146, 10157, 10163, 10170, 10177, 10191, 10200, 10217, 10247, 10264, 10290, 10346, 10361, 10362, 10370, 10411, 10418, 10421, 10473, 10480, 10492, 10512, 10535, 10544, 10556, 10618, 10631, 10668, 11037, 11437
Televideon	10216, 10320	Tongguang	10264, 10412	Univox	10037, 10087, 10163, 10337
Television	10037	Tongtel	10587, 10780	Utax	10163
Tempest	10009, 10037, 10264, 10455, 10556	Tophouse	10180	V2max	10865
Tennessee	10037	Toshiba	10009, 10035, 10036, 10060, 10070, 10093, 10102, 10109, 10145, 10154, 10156, 10191, 10195, 10217, 10264, 10381, 10412, 10508, 10556, 10618, 10644, 10650, 10714, 10718, 10821, 10832, 10845, 11156, 11256, 11265, 11356, 11508, 11656, 11704	V7 Videoseven	11755
Tensai	10009, 10037, 10104, 10105, 10163, 10217, 10218, 10247, 10320, 10371, 10374, 10377, 10556, 10715, 11037	Tosonic	10185	V7Videoseven	10880
Tenson	10009, 10320	Totevision	10039	Vector Research	10030
Tera	10030, 10092, 10466	Towada	10102, 10217, 10264	Vestel	10037, 10163, 10217, 10556, 10668, 11037, 11163
Tesla	10037	Toyoda	10009, 10037, 10264, 10412	Victor	10036, 10053, 10250, 10650, 10653
Tevion	10556, 10648, 10668, 10714, 10767, 11037, 11137	Trakton	10009, 10217, 10264	Videocon	10508
Texet	10009, 10216, 10217, 10218, 10374	Trans Continens	10037, 10217, 10668, 11037	Videologic	10216, 10218
ThemeScene	10887	TRANS-continent	10621	Videologique	10218
Thomson	10037, 10109, 10287, 10335, 10560, 10625, 11447	Transonic	10009, 10037, 10264, 10418, 10455, 10512, 10587, 10698, 10712, 10780, 10858	Videomac	10009, 10264
Thorn	10035, 10036, 10037, 10072, 10073, 10104, 10109, 10163, 10193, 10238, 10335, 10359, 10361, 10499, 10512, 10535	Triad	10037, 10218, 10556	Videosat	10247
		Trical	10157	Videotechnic	10217, 10320
		Trident	10516	Videoton	10356
		Tristar	10193, 10218	Vidikron	10054
		Triumph	10177, 10346, 10516, 10556	Vidtech	10019, 10036, 10178
				Viewsonic	10724, 10857, 10864, 10885, 11755

Viking	10046
Vinc	11756
Vision	10032, 10037, 10217, 10264, 10320
Vistar	10206, 10361, 10548
Vizio	10864, 10885, 11756
Voxson	10087, 10163, 10178, 10363, 10418
Waltham	10037, 10109, 10163, 10217, 10356, 10418, 10443, 10668, 11037
Wards	10000, 10016, 10017, 10018, 10019, 10020, 10021, 10024, 10027, 10030, 10047, 10051, 10054, 10055, 10056, 10060, 10080, 10096, 10111, 10135, 10154, 10156, 10165, 10166, 10178, 10179, 10180, 10186, 10187, 10866, 11147, 11156, 11347
Warumaia	10374, 10661
Watson	10009, 10037, 10218, 10320, 10394, 10579, 10668, 11037, 11437
Watt Radio	10102, 10216, 10544
Waycon	10156
Wega	10036, 10037, 10087
Wegavox	10037
Weipai	10009
Welltech	10714
Weltblick	10217, 10320
Westinghouse	10003, 10889
Weston	10037
Wharfedale	10037, 10264, 10556, 10706, 10861
White Westinghouse	10037, 10186, 10216, 10320, 10337, 10463, 10623
Windsor	11037
Windstar	10282, 10337
Windy Sam	10556
Wintel	10714
World-of-Vision	10880
Worldview	10455
Xenius	10634, 10661

Xiahua	10009, 10264, 10412, 10698, 10773, 10779, 10817
Xianghai	10009
Xiangyang	10264, 10412
Xiangyu	10009
Xihu	10264, 10412, 10817
Xinaghai	10412
Xingfu	10009
Xinghai	10264
Xinrisong	10848
XLogic	10698
XMS	10698
Xoceco	10779, 10785
Xrypton	10037
Xuelian	10848
Yamaha	10019, 10030, 10650, 10769, 10833, 10839
Yamishi	10217, 10282, 10455
Yapshe	10250
Yingge	10009
Yokan	10037, 10109
Yoko	10009, 10037, 10216, 10217, 10218, 10247, 10264, 10339, 10421
Yongbao	10848
Yonggu	10009
Yoshita	10706
Youlanasi	10817
Yousida	10009, 10848
Yuhang	10009
Zanela	10238
Zanussi	10206, 10264, 10363
Zenith	10016, 10017, 10092, 10178, 10463
Zenor	10208, 10339
ZhuHai	10009, 10374
Zonda	10003, 10698, 10779
ZX	10418

## CABLE

ABC	00003, 00007, 00008, 00011, 00013, 00014, 00017, 00237
ADB	01063, 01269
Aichi Denshi	01512
Alcatel	00896
Allegro	00153, 00315
Americast	00899
Amstrad	01222
Antronix	00022
Archer	00022, 00153, 00797
Auna	00277, 01269
Austar	00012, 00276
Bell & Howell	00014
Bell South	00899
Birmingham Cable Communications	00276
British Telecom	00003
Cable & Wireless	01068
Cabletenna	00022
Cabletime	00448, 00665
Cableview	00022
Canal Plus	00443
Century	00153
Citizen	00153, 00315
Clearmaster	00883
ClearMax	00883
Comcrypt	00443
Comtronics	00040
Contec	00019
Coolmax	00883
Cryptovision	00600
Daeryung	00008, 00277, 00477, 00877, 01877
Digeo	01187
Digi	00637
Director	00476
Dumont	00637

DX Antenna	01500
Eastern	00002
Emerson	00797
Everquest	00015, 00040
Filmnet	00443, 00619
Focus	00400
Foxtel	01222
France Telecom	00451, 00817, 00896
Freebox	01482
Fujitsu	01497
Funai	00019
Galaxi	00008
Garrard	00153
GE	00237
Gehua	00476
Gemini	00015, 00797
General Instrument	00003, 00011, 00014, 00015, 00276, 00476, 00810
GMI	00015, 00797
Golden Channel	01063, 01110
GoldStar	00040, 00144
Goodmind	00797
Hamlin	00009, 00020, 00034, 00259, 00273
Hitachi	00011, 00014
HyperVision	00619
Hytex	00007
i3 Micro	01602
Jasco	00015, 00153, 00315
Jebsee	00400
Jerrold	00003, 00011, 00012, 00014, 00015, 00276, 00476, 00810
KNC	00008
Leon	00015
LG	00040, 00144
Macab	00817
Magnavox	00014
Maspro	01510

Memorex	00000
MNET	00019, 00443
Moser	00451
Motorola	00276, 00476, 00810, 01106, 01187, 01254, 01376, 01483
Movie Time	00063
Mr Zap	01112
Mr. Zap	01112
MS	00015
Multichoice	00019, 00443
Multitech	00883
MultiVision	00012
Myrio	01602
NEC	01496
Nokia	01569
Noos	00817
NSC	00063
NTL	00003, 00250, 00277, 01060, 01068
Oak	00007, 00019
Ono	01068
Optimus	00021
Optus	00276, 01060
Pace	00008, 00237, 01060, 01068, 01368, 01877
Panasonic	00000, 00008, 00021, 00040, 00107, 00443, 01488
Panther	00637
Paragon	00000
Philips	00013, 00153, 00317, 00619, 00817, 01305
Pioneer	00144, 00533, 00877, 01500, 01877
Popular Mechanics	00400
Pulsar	00000
PVP Stereo Visual Matrix	00003
Quasar	00000
Quiero	00817

RadioShack	00015, 00315, 00797, 00883
RCA	00021, 01256
Recoton	00400
Regal	00020, 00259, 00273, 00279
Regency	00002
Rembrandt	00011
Runco	00000
Sagem	00817, 01089, 01112
Salora	00000
Samsung	00000, 00040, 00144, 01060
Scientific Atlanta	00008, 00017, 00237, 00277, 00477, 00877, 01510, 01877
Sejin	01602
Signal	00015, 00040
Signature	00011
SL Marx	00040
Sony	01006, 01460
Sprucer	00021
Starcom	00003, 00014, 00015
Stargate	00015, 00040, 00797
Starquest	00015
Sumitomo	01500, 01504
Supercable	00276
Supermax	00883
Tadiran	00040
Tandy	00258
Tele Danmark	01016
Tele+1	00443
Telepiu	00443
Televiow	00040
Telewest	01068, 01368
Thomson	01110, 01256
Time Warner cable	01877
Timeless	00040
Tocom	00012, 00013
Torx	00003
Toshiba	00000, 01509

Trans PX	00153, 00276, 00315
TransACT	01106
Tri-Vision	01257
Tristar	00883
TS	00003
Tusa	00015
TV86	00063
Unika	00022, 00153
United Artists	00007
United Cable	00003
Universal	00022, 00153, 00191
US Electronics	00276
V2	00883
Videotron	00250
Videoway	00250
Viewmaster	00883
Viewstar	00063, 00258
Vision	00883
Visionetics	01064
Visiopass	00451
Vortex View	00883
Zenith	00000, 00008, 00525, 00899
Zentek	00400

## SATELLITE

@sat	01300
@Sky	01334
ABsat	00123, 00668, 00713, 00832
ADB	00642, 00887, 01259, 01367, 01473, 01491, 01492, 01493, 01494, 01495
Aegir	00520
AGS	00668, 00710
Aiwa	01514
Akai	00200, 00515
Akena	00668
Alba	00421, 00455, 00515, 00613, 00713
Aldes	00520

Allsat	00200, 01017, 01043
Allsonic	00369
Alltech	00713
Allvision	01232, 01334, 01412
Alpha	00668
AlphaStar	00772
Amitronica	00713
Ampere	00132, 00396, 00829
Amstrad	00132, 00243, 00345, 00396, 00501, 00675, 00689, 00713, 00742, 00795, 00847, 00863, 00882, 00885, 01113, 01175
Anglo	00713
Ankaro	00369, 00692, 00713, 01279
AntSat	01017, 01083
Anttron	00421, 00613
Apollo	00421, 00455
Arcon	00692, 00834, 01043, 01075, 01205, 01279
Arcus	01143
Arion	01205
Armstrong	00243
Arnion	01300
ASA	00397
Asat	00200
ASCI	00114, 01334
ASLF	00713
AssCom	00853
AST	00321, 00351
Astacom	00668, 00710
Aston	00142, 01261
Astra	00243, 00607, 00713
Astrastar	00548
Astro	00133, 00173, 00358, 00369, 00501, 00520, 00548, 00607, 00613, 00658, 01099, 01100, 01113
Athena	00668

Atsat	01300
AtSky	01334
Audioline	01429
Audioton	00613
Aurora	00642, 00879
Austar	00497, 00642, 00863, 00879, 01173, 01259
Avalon	00396
Axiel	00668, 00710
Axis	00369, 00834, 00880, 01111
Beko	00455
Bentley Walker	01017
Best	00369
Bestar	00243
Black Diamond	01284
Blaupunkt	00173
Blue Sky	00713, 00885
Boca	00132, 00243, 00713, 00794, 00829, 01232
Boston	00132, 00668, 00710
Brainwave	00692, 01294
British Sky Broadcasting	00847, 01175, 01847
Broco	00713
BskyB	00847, 01175
BT	00515, 00668, 00710
Bubu Sat	00713
Bush	01284, 01471
BVV	00692
Cambridge	00501, 00515
Canal Digital	00853
Canal Satellite	00853, 01339
Canal+	00853
CanalSatellite	00853, 01339
CCE	00345
Century	00856
Channel Master	00212
Chaparral	00053, 00209, 00216

Cherokee	00123, 00710, 01480
Chess	00114, 00713, 01085, 01334
CityCom	00115, 00299, 00607, 00818, 01075, 01176, 01232
Claasen Nachrichten	00520
Clark	00613
Clemens Kamphus	00396, 00834
CNS	01367
CNT	00520
Cobra	00396
Colombia	00132, 00668
Columbia	00132
Columbus	00668
Comag	00132, 01232, 01412
Condor	00369, 00607
Connexions	00396
Conrad	00115, 00132, 00369, 00501, 00607
Conrad Electronic	00607
Cosat	00592
Crossdigital	01109
Crown	00243
Cryptovision	00455
Cyfra+	01076
Cyrus	00200
D-box	00723, 00873
Daeryung	00396
Daewoo	00421, 00713, 01111, 01296
Daumling	00794
Delfa	00863
Deltasat	01075
Dgtec	01242, 01542
Digatron	01294
Digena	01100
Digenius	00299, 01161
Digiality	00607
Digipro	01105
DigiQuest	00863
DigitAll World	01227

Digiturk	01076
DirecTV	00099, 00247, 00392, 00566, 00639, 00724, 00749, 00819, 01076, 01108, 01109, 01142, 01377, 01392, 01414, 01442, 01443, 01444, 01609, 01639, 01640, 01749, 01856
Discoverer	00605
Discovery	00668, 00710, 01480
Dish Network	00775
Dish Network System	00775, 01005, 01170, 01505, 01775
Dishpro	00775, 01005, 01505, 01775
Distratel	00084, 00885, 01205, 01283
Distrisat	00200
DMT	01075
DNR	00692
DNT	00200, 00396
Dream Multimedia	01237, 01437, 01537, 01637
DST	00421
Dune	00369
DX Antenna	01530
Echostar	00159, 00167, 00269, 00280, 00396, 00454, 00610, 00668, 00713, 00775, 00853, 00871, 01005, 01086, 01170, 01200, 01323, 01409, 01467, 01477, 01505, 01775
EIF	00417
Einhell	00132, 00243, 00421, 00501, 00692, 00713, 00794
Elap	00587, 00668, 00710, 00713
Elsat	00713
Elta	00200, 00369, 00421
Emanon	00421
Emme Esse	00369, 00871
eMTech	01214
Engel	00713, 01017
Eurieult	00084, 00136, 00417, 00882, 00885

Euro1	01278
Eurocrypt	00455
EuroLine	01251
Europa	00501, 00607, 00863
European	00794
Europhon	00132, 00299, 00607
Eurosat	00243
Eurosky	00114, 00115, 00132, 00243, 00299, 00369, 00501, 00607
Eurostar	00115, 00607, 00818, 00880, 00898
Eutelsat	00713
Exator	00421, 00515, 00613
Expressvu	00775, 01775
Fagor	00592
Fenner	00157, 00369, 00605, 00668, 00713
Ferguson	00455, 00711, 01291
Fidelity	00501, 00675
Finlandia	00455
Finlux	00397, 00455, 00573
Flair Mate	00713
Force	01101, 01194
Fortec Star	01017, 01083, 01293
Foxtel	00455, 00497, 00720, 00879, 01162, 01173, 01176, 01356
Fracarro	00421, 00668, 00871
Freecom	00173, 00421, 00501
Freesat	00882
Fresat	00885
FTEmaximal	00331, 00369, 00713, 00794, 00863, 01209, 01449
Fuba	00115, 00173, 00299, 00369, 00396, 00417, 00421, 00573, 01161, 01214
Fugionkyo	01105
Galaxis	00115, 00369, 00592, 00692, 00834, 00853, 00863, 00879, 01101, 01111, 01557
Galaxisat	00321



Gardiner	00818	Hnsel & Gretel	00132	Italtel	00871
Garnet	01075	Homecable	00238	Jadeworld	00642
GbSAT	01214	Homecast	01214	Jaeger	01334
GE	00566	Houston	00396, 00592, 00668	Janeil	00152
Gecco	01273, 01412	HTS	00775, 01775	JOK	00690, 00710
General Instrument	00869	Hughes	00749	Jolly	00592
GF	00834, 01043	Hughes Network Syst		JVC	00492, 00515, 00571, 00775, 01170, 01507, 01531, 01775
GF Star	01043		00749	K-SAT	00713
Globo	01087, 01251	Hughes Network Systems		Kamm	00713, 00880
GOD Digital	00200		00749, 01142, 01442, 01443, 01444, 01749	Kaon	01300
GOI	00775, 01775	Humax	00863, 01176, 01225, 01427, 01568	KaTelco	01111
Gold Box	00853	Huth	00132, 00243, 00607, 00692, 00794, 00829, 01017, 01075	Kathrein	00114, 00115, 00123, 00173, 00200, 00249, 00331, 00358, 00442, 00480, 00553, 00613, 00658, 00713, 00742, 00818, 00898, 01057, 01221, 01561, 01567
Goldbox	00292, 00853	Hwalin	00885	Kathrein Eurostar	00115
Golden Interstar	01283	Hypson	00136, 00417	Kenwood	00853
Goldvision	01017	Hyundai	01011, 01075, 01159	Key West	00132, 00794
Gooding	00571	iCan	01367	Kiton	00114
Goodmans	00455, 01246, 01284	ID Digital	01176	Klap	00668, 00710
Gradiente	00099, 00856, 00887	IEEC	00605	Kolon	00421
Granada	00455	ILLUSION sat	01557	Konig	00607
Grandin	00084, 00136, 00417, 00885	iLo	01535	Koscom	00834, 01043, 01334, 01409
Grococ	00243	Imex	00084, 00136, 00520	Kosmos	00331, 00442
Grundig	00173, 00345, 00455, 00501, 00571, 00750, 00805, 00847, 00853, 00879, 01150, 01291, 01330, 01335, 01435	Imperial	01429	KR	00592, 00613
Hanseatic	00605, 01099, 01100	Indovision	00887	Kreiling	00114, 00249, 00658, 01461, 01480
Hantor	00421	Ingelen	00114, 00396, 00882	Kreismeyer	00173
Hanuri	00520	Innova	00099	Kyostar	00421, 00613
Hauppauge	01294, 01298	International	00132, 00243	L&S Electronic	00132, 00369, 01043, 01334
HB	01214	Interstar	01017, 01105, 01214	Labgear	01296
HDT	01011, 01159	Intertronic	00243	LaSAT	00115, 00132, 00157, 00173, 00243, 00299, 00369, 00520, 00607
Helium	00607	Intervision	00592, 00607, 00628	Legend	00269
Hinari	00421	InVideo	00871	Lemon	00692, 01461
Hirschmann	00173, 00299, 00369, 00396, 00397, 00501, 00573, 00607, 00668, 00710, 00882, 01012, 01085, 01111, 01113	IQ	00210	Lenco	00115, 00369, 00421, 00607, 00628, 00692, 00713
Hisense	01535	IQ Prism	00210		
Hitachi	00455, 00489, 00819, 01250, 01284, 01518, 01523, 01525, 00035	IR	00173, 00282, 00331, 00358, 00455		
		Irdeto Technology	00879		
		ISkyB	00887		

Lennox	00592
Lenson	00501
Leyco	00515
LG	01075, 01226, 01414
Lifesat	00132, 00157, 00299, 00369, 00605, 00713, 01043, 01122
Lifetec	00587
Lodos	01284
Loewe	00243
Logix	01017, 01075
Lorenzen	00132, 00299, 00607, 00692, 00742, 00794, 00867, 01161, 01294
Lupus	00369
Luxor	00345, 00501, 00573
M vision	01557
Magnavox	00722, 00724
Manata	00132, 00136, 00417, 00668, 00710, 00713
Manhattan	00455, 00520, 00592, 00834, 01017, 01083
Marantz	00200
Marave	00417
Mascom	00520
Maspro	00173, 00571, 00692, 00713, 00750, 01530
Mastec	01334
Matsui	00173, 00571, 00710, 01284
Matsushita	00500
Max	00607
Maximum	01075, 01334
MB	00605
MDS	01225
Mediacom	01206
Mediamarkt	00243
MediaSat	00292, 00501, 00853
Medion	00132, 00299, 00369, 00713, 01043, 01075, 01161, 01232, 01334, 01412

Medison	00713
Mega	00200
Meletronic	00818
Memorex	00269, 00724
Metronic	00084, 00132, 00136, 00243, 00421, 00520, 00613, 00713, 00818, 00885, 01205, 01215, 01279, 01282, 01283, 01334
Metz	00173
Micro	00501, 00607, 00613, 00713, 01294
Micro electronic	00713
Micromaxx	00299, 00369
Microstar	01075
Microtec	00713
Minerva	00571
Mitsubishi	00455, 00749
Morgan's	00132, 00200, 00243, 00713, 00794, 00829, 01232
Motorola	00856, 00869
Multichoice	00642, 00879
Multistar	00331
Myryad	00200
Mysat	00713
NEC	00496, 01270, 01519
NEOTION	01334
Netgem	01322
Netsat	00099, 00887
Neuhaus	00501, 00592, 00607, 00692, 00713, 00834
Neuling	00132, 01232
Neusat	00587, 00692, 00713, 00834, 01279, 01334, 01409
Neveling	01161
Newton	00396
Next Level	00869
NextWave	01017, 01143
Nikko	00200, 00243, 00713

Nokia	00397, 00455, 00573, 00723, 00751, 00853, 00873, 01023, 01223, 01310, 01311, 01312, 01723
Nordmende	00421, 00455, 00520
Octagon	00421, 00613
OctalTV	01294, 01505
Okano	00243, 00331, 00442, 00668
Opentel	01232, 01412
Optex	00114, 00136, 00417, 00592, 00834, 01043, 01283
Optus	00879, 01143
Orbis	01334
Orbit	00351
Orbitech	00114, 00157, 00421, 00501, 00548, 00834, 01099, 01100
Origo	00497
OSAT	00345
Ouralis	01205
Oxford	00515, 00668
Pace	00200, 00241, 00329, 00455, 00497, 00720, 00791, 00795, 00847, 00853, 00867, 00879, 00887, 01175, 01323, 01356, 01423, 01623
Pacific Satellite	00834
Packard Bell	01111
Packsat	00710
Palcom	00299, 00587, 01161
Palladium	00243, 00396, 00421, 00501, 00571
Palsat	00157, 00501
Panarex	01159
Panasat	00615, 00879
Panasonic	00152, 00247, 00455, 00500, 00701, 00847, 01304, 01320, 01404, 01508, 01526
Panda	00173, 00455, 00607, 00834
Pansat	01011, 01159
Patriot	00132, 00515, 00668, 00710

Paysat	00724
Philips	00099, 00133, 00173, 00200, 00292, 00455, 00571, 00613, 00668, 00710, 00722, 00724, 00749, 00750, 00805, 00818, 00853, 00856, 00887, 00898, 01076, 01114, 01118, 01142, 01442, 01749
Phoenix	01273
Phonotrend	00592, 00863, 01017, 01200
Pilotime	01339
Pino	01334
Pioneer	00292, 00329, 00352, 00853, 01308
Planet	00396, 00871
Plasmatic	00442
Polytron	00396
Praxis	01123
Predki	00421
Preisner	00132, 00396, 00794, 01101, 01113
Premier	00292, 00592
Premiere	00292, 00723, 00873, 01429
Prima	00795
Primacom	01111
Pro Visat	00520
Prod	00573, 00639, 00723, 00873
Profile	00710
Promax	00455
Prosat	00628, 01173
Proscan	00392, 00566
Protek	01567
Proton	01535
ProVision	00520
Pye	00571
Pyxis	00834
QNS	01367, 01404
Quadral	00369, 00628, 00668, 00710, 01012
Quelle	00115, 00299, 00607, 00742
Radiola	00200
RadioShack	00869

Radix	00285, 00396, 00882, 01113
Rainbow	00613
RCA	00143, *[00392], 00566, 00855, 01291, 01392
Realistic	00052
Rebox	01214
Red Star	00369
Regal	01251
RFT	00200
Roadstar	00713, 00853
Roch	00136
Romsat	00421
Rover	00369, 00628, 00713
S-ZWO	01207
SAB	01251
Saba	00115, 00520, 00607, 00690, 00692, 00710, 00885, 01012
Sabre	00455
Sagem	00820, 01114, 01253, 01307
Samsung	00853, 00863, 01017, 01108, 01109, 01206, 01243, 01244, 01276, 01292, 01293, 01343, 01377, 01442, 01458, 01570, 01609
Sanyo	00493, 01219
SAT	00321, 00351, 00501, 00675
Sat Control	01300
Sat Cruiser	01143
Sat Partner	00421, 00501, 00520, 00613, 00692
Sat Team	00713
Satcom	00605, 00607
Satec	00713, 00834
Satelco	00369, 01232
Satline	00628
Satplus	00157, 01100
Satstation	01083
Schaub Lorenz	01214
Schcke	00613

Schneider	00157, 00668, 00710, 00805, 00898, 01206, 01251
Schwaiger	00132, 00157, 00587, 00605, 00607, 00692, 00863, 00885, 01075, 01083, 01111, 01334, 01474
SCS	00115, 00299
Sedea Electronique	00132, 00421, 01105, 01206, 01283
Seemann	00243, 00396, 00515
SEG	00114, 00369, 00421, 00605, 00742, 01075, 01087, 01191, 01251
Seleco	00592, 00871
Septimo	00885, 01205
Serino	00610
Servi Sat	00136, 00592, 00713
ServiSat	01251
Sharp	00494, 01517
Siemens	00173
Silva	00299
Skantin	00713
Skardin	00587
SKR	00713
SKT	01449
SKY	00099, 00711, 00847, 00856, 00887, 01014, 01175, 01847, 01848, 01856
SKY Italia	01847, 01848
Sky Television	01014
Sky XL	01251, 01412
Sky+	01175
Skymaster	00157, 00587, 00605, 00628, 00713, 00880, 01075, 01085, 01200, 01409
Skymax	00200
Skyplus	01232, 01334, 01409, 01412
SkySat	00114, 00157, 00501, 00605, 00607, 00713
Skyvision	01334
SL	00132, 00243, 00299, 00692, 00742, 01294

SL Marx	00692
SM Electroni	00157, 00587, 00713, 01200, 01409
Smart	00115, 00132, 00299, 00396, 00713, 00794, 00829, 00882, 01101, 01113, 01232, 01273
Sony	00275, 00282, 00292, 00294, 00486, 00489, 00492, 00493, 00494, 00496, 00500, 00639, 00847, 00853, 01524, 01558, 01639, 01640
SR	00132, 00243
Star	00887
Star Choice	00869
Star Trak	00180, 00421
Starland	01122
Starlite	00200
Stream	01847, 01848
Strong	00132, 00369, 00421, 00520, 00613, 00853, 00879, 01105, 01147, 01158, 01159, 01300, 01409
STS	00210
STVI	00136, 00417
Sunkai	00123
Sunny	01300
Sunny Sound	00369
Sunsat	00713
Sunstar	00132, 00243, 00369, 00642, 00794, 00829
Supermax	01143, 01283
Supernova	00887
Tantec	00455
Tarbs	01225
Tatung	00455
TCL	01143
Teac	01225, 01227, 01251, 01322
Techniland	00592
TechniSat	00114, 00157, 00200, 00396, 00455, 00501, 00548, 00863, 01099, 01100, 01195, 01322

Technomate	01283
Technosat	01143, 01206
Technotrend	01429
Technowelt	00132, 00607
Techsan	01017
Techwood	00114, 01284
Teco	00243
tekComm	01017
Telasat	00115, 00605, 00607
Teleciel	00613, 01043
Telefunken	00421
Teleka	00243, 00396, 00501, 00607, 00613, 00692, 00750, 00834
Telemaster	00520
Telesat	00605
Telestar	00114, 00157, 00501, 01099, 01100, 01251, 01334
Telesystem	00396, 01251
Teletech	00114, 00880
Televes	00132, 00455, 00501, 01214, 01300
Televisa	00887
Telewire	00592
Tempo	01143
Tevion	00713, 01334, 01409
Thomson	00115, 00292, 00392, 00455, 00607, 00668, 00710, 00711, 00713, 00820, 00847, 00853, 01012, 01046, 01175, 01291, 01498, 01900
Thorn	00455
Tioko	00132, 00243
Tivo	01142, 01442, 01443, 01444
Tokai	00200
Tonna	00455, 00501, 00587, 00592, 00668, 00713, 00834
Topfield	01206, 01207, 01545

Toshiba	00082, 00455, 00486, 00749, 00790, 01285, 01446, 01501, 01516, 01530, 01749
TPS	00820, 01253, 01307
Triad	00321, 00351, 00372
Triasat	00501
Triax	00114, 00115, 00132, 00200, 00396, 00501, 00713, 00853, 01099, 01113, 01227, 01251, 01291, 01296
Trio	01075
TT-micro	01429
Turnsat	00713
Twinner	00136, 00713
UEC	00879, 01162
Uher	00157
UltimateTV	01392, 01640
Uniden	00052, 00074, 00076, 00238, 00722, 00724, 00834
Unisat	00132, 00200, 00243
United	01251
Universum	00114, 00115, 00173, 00299, 00397, 00571, 00607, 00675, 00742, 01087, 01099, 01251
US Digital	01535
USDTV	01535
Van Hunen	01161
Variosat	00173
Vega	00369
Ventana	00200
Vestel	00114, 00742, 01251
Victor	00492
Visionic	01105, 01206, 01279, 01283
Visiosat	00114, 00142, 00690, 00710, 00713
Vivid	01162
Voom	00869
Vortec	00421
VTech	00321, 00351, 00690, 00818
Welltech	00157

Wetekom	00157, 00501, 00605, 00829
Wewa	00455
Wibo	00243
Wintel	00299, 01161
Wisi	00173, 00299, 00321, 00351, 00372, 00396, 00455, 00501, 00607, 00638, 00690
Woorisat	00520
Worldsat	00114, 00123, 00668, 00710, 01012, 01251, 01323, 01480
Xcom	00123, 00668, 00832
Xcom Multimedia	00668
XMS	01075
Xrypton	00369
Xsat	00123, 00668, 00713, 00847, 01214, 01323
Xtreme	01300
Yes	00887
Zaunkonig	00692
Zehnder	00114, 00115, 00321, 00331, 00369, 00520, 00742, 00818, 01075, 01191, 01232, 01251, 01334, 01412
Zenith	00856, 01856
Zinwell	01173
Zodiac	00396, 00613
Zwergnase	00243, 00794

## CD

Acoustic Research	30420
ADC	30018
Adcom	30155, 30234
Advantage	30032
Aiwa	30012, 30124, 30157, 31690
Akai	30156, 30766, 31688
Arcam	30157
Audio Alchemy	30194
Audio Dynamics	30018

Audio Pro	30437
Audio Research	30157
Audio-Technica	30170
Audiolab	30157
Audiomeca	30157
Audioton	30157
Bestar	30164
BSR	30194, 30245
Burmester	30420
Bush	30245
Cairn	30157
California Audio Labs	30029, 30303
Cambridge	30157
Carrera	30194
Carver	30157, 30179, 30437
CCE	30157
CDC	30420
CEC	30174, 30420
Classic	31297
Condor	30164, 30194
Copland	30393
Crown	30122
Cyrus	30157
DAK	30245
DBX	30018, 30254
Denon	30003, 30626, 30766, 30873, 31234, *[31867], 31868
DKK	30000
DMX Electronics	30157
Dual	30003, 30194, 30196
Dynamic Bass	30179
EEC	30194
Elektra	30437
Emerson	30155, 30164, 30305, 30469
Fisher	30088, 30174, 30179, 30342, 31325
Garrard	30245, 30280, 30393, 30420, 30425
GE	30009

Genexxa	30032, 30164, 30305, 30426
Goldmund	30157
GoldStar	30417, 31208
Goodmans	30245, 30280, 30305
GPX	31296
Grundig	30157
Harman/Kardon	30157, 30173, 30426, 31202
Hitachi	30032, 30155, 30038
Inkel	30180, 30196, 30437
Integra	30101
Intersound	30245
IR	30000
JVC	30072, 30655, 31294, 31697
Kenwood	30028, 30036, 30037, 30157, 30190, 30626, 30681, 30826
KLH	31318, 31711
Kodak	30287
Korsun	31484
Koss	31317
Krell	30157
Kyocera	30018
LG	31208
Linn	30157
Loewe	30157
Luxman	30093, 30393
LXI	30305
Magnavox	30157, 30305
Marantz	30029, 30157, 30180, 30626
Mark	30194
Mark Levinson	31484
Matsui	30157
McIntosh	30287
MCS	30029, 30043
Memorex	30032, 30155, 30164, 30175, 30180, 30305
Meridian	30157
Micromega	30157

Miro	30000
Mission	30157
Mitsubishi	30156
MTC	30420
Musical Fidelity	30393, 30437
Myryad	30157
NAD	30000, 31208
Nagaoka	30018
Naim	30157
Nakamichi	30147
NEC	30043, 30234
Nikko	30164, 30170, 30174
NSM	30157
Oak	30145
Onkyo	30101, 30868, 31685
Optimus	30000, 30032, 30037, 30087, 30145, 30175, 30179, 30194, 30196, 30280, 30305, 30342, 30420, 30426, 30437, 30468, 31063, 31075
Orion	30393
Panasonic	30029, 30207, 30303, 30752, 31682
Parasound	30194, 30420
Penney	30043
Perform Hifi	30420
Philips	30157, 30287, 30626
Pioneer	30032, 30101, 30305, 30468, 31062, 31063, 31087
PMG	30164
Polk Audio	30157
Poppy	30164
Proceed	30420
Proton	30157
QED	30157
Quad	30157
Quasar	30029
Radiola	30157
RadioShack	31075

RCA	30009, 30032, 30053, 30155, 30179, 30305, 30420, 30468, 30764, 31062
Realistic	30155, 30164, 30175, 30179, 30180, 30420
Restek	30157
Revox	30157
Roadstar	30461
Roksan	30420
Rotel	30157, 30420
Royal	30164, 30420
SAE	30157
Sansui	30157, 30202, 30305
Sanyo	30087, 30179, 30342
SAST	30157
Scott	30155, 30164, 30305
Sears	30305
Sharp	30037, 30180, 30861, 31658, 31684
Sherwood	30180, 30196, 30426, 31067
Shure	30043
Siemens	30157, 30180
Silsonic	30036, 30888
Simaudio	30157
Sonic Frontiers	30157
Sony	30000, 30100, 30185, 30490, 30604, 30605, 31364
Soundesign	30145, 30425
STS	30018
Sugden	30157
Symphonic	30305
TAG McLaren	30157
Tandy	30032
Tascam	30420
TDK	31208
Teac	30174, 30180, 30393, 30420
Tec	30245
Technics	30029, 30207, 30303
Thomson	30053

Thorens	30157
Thule Audio	30157
Tivoli Audio	31553
Tokai	30164, 30420
Toshiba	31693
Traxdata	30626
Universum	30053, 30157, 30437
Vector Research	30194, 30417
Victor	30072
Wards	30000, 30032, 30053, 30087, 30157, 30179
Yamaha	30000, 30032, 30036, 30037, 30170, 30187, 30888, 31292
Yoko	30194
Yorx	30461
Zonda	30157

## CDR

Classic	31297
Denon	30626, 30766, 31868
Fisher	31325
GPX	31296
Harman/Kardon	31202
JVC	30072, 31294
Kenwood	30626
LG	31208
Marantz	30626
NAD	31208
Philips	30626
Pioneer	31062, 31087
RCA	30053, 30420
Sony	30000, 30100, 31364
TDK	31208
Teac	30420
Yamaha	30888, 31292

## TAPE

Aiwa	20029, 20197, 20200, 21315
Akai	20283, 20439
Arcam	20076
Carver	20029
Denon	20076, 20371, 21311, 21471
Fisher	20074
Garrard	20308, 20309, 20375, 20439
Genexxa	20439
GoldStar	20353, 20375
Grundig	20029, 20229, 20375
Harman/Kardon	20029, 20182, 21314
Inkel	20070, 20071, 20337
JVC	20244, 20273, 20274, 20303, 20304, 20310, 21309
Kenwood	20070, 20071, 20092, 20233, 20234, 21364
LG	20375
Luxman	20308, 20309
Magnavox	20029
Marantz	20009, 20029
Memorex	20099
Mitsubishi	20283, 20439
Myryad	20029
Onkyo	20135, 20136, 20282
Optimus	20027, 20220, 20337, 20439
Orion	20308, 20309, 20353
Panasonic	20229
Philips	20029, 20229
Phonotrend	20337
Pioneer	20027, 20099, 20220, 21306, 21312
Polk Audio	20029
Radiola	20029
RCA	20027, 20220
Revox	20029, 20190
Sansui	20009, 20029
Sanyo	20074
Sharp	20231, 20371
Sherwood	20337

Siemens	20029
Sonic	20375
Sony	20170, 20234, 20243, 20291, 21313
TaeKwang	20439
Tandberg	20109
Teac	20280, 20283, 20289, 20308, 20309
Technics	20229, 20353
Thorens	20029
Universum	20375, 20439
Victor	20244, 20273, 20274
Wards	20027, 20029
Wharfedale	20439
Yamaha	20094, 20097

### **PVR ※1**

ABS	21972
Alienware	21972
CyberPower	21972
Dell	21972
DirecTV	20739
Gateway	21972
Hewlett Packard	21972
Howard Computers	21972
HP	21972
Hughes Network Systems	20739
Humax	20739
Hush	21972
iBUYPOWER	21972
Linksys	21972
Media Center PC	21972
Microsoft	21972
Mind	21972
Niveus Media	21972
Northgate	21972
Panasonic	20616
Philips	20618, 20739

RCA	20880
ReplayTV	20614, 20616
Sonic Blue	20614, 20616
Sony	20636, 21972
Stack 9	21972
Systemax	21972
Tagar Systems	21972
Tivo	20618, 20636, 20739
Toshiba	21008, 21972
Touch	21972
Viewsonic	21972
Voodoo	21972
ZT Group	21972

### **TV/DVD Combination ※2, ※3**

Advent	41016
Apex Digital	40830
Audiovox	41071, 41121, 41122
Axion	41071
Broksonic	40695
Bush	40516, 40713, 40884
Denver	41353, 41359
Emerson	41268
Go Vision	41071
Grundig	40695
Hitachi	41247
Jensen	41016
Konka	40719, 40720
Panasonic	41490
Philips	40854, 41260
Prima	41016
RCA	41022
Samsung	40899
Sansui	40695
Sova	41122
Sylvania	40675, 41268

Toshiba	40695
Bush ※3	10698, 11037
Denver ※3	10587
Sylvania ※3	10171

### TV/VCR Combination ※3, ※4

America Action ※3	10180
Audiovox ※3	10180
Emerson ※3	10236
Funai ※3	11977

※4

Aiwa	20000, 20479
America Action	20278
Audiovox	20278
Broksonic	20002, 20479, 21479
Citizen	21278
Colt	20072
Curtis Mathes	21035
Daewoo	21278
Emerson	20002, 20294, 20479, 21278, 21479
Funai	20000, 21333
GE	20240, 20807, 21035, 21060
GoldStar	21237
Harley Davidson	20000
Hitachi	20000
Lloyd's	20000
Magnasonic	21278
Magnavox	20000, 21781
Magnin	20240
Memorex	20162, 21237
MGA	20240
Mitsubishi	20043, 20807
Optimus	20162
Orion	20002, 20479, 21479
Panasonic	20162, 21035, 21308
Penney	20240, 21035, 21237

Philco	20479
Quasar	20162, 21035
RadioShack	20000
RCA	20240, 20807, 21035, 21060
Samsung	20432, 21014
Sansui	20000, 20479, 21479
Sanyo	20240, 21330
Sears	20000, 21237
Sharp	20807
Sony	20000, 21232, 21295
Sylvania	21781
Symphonic	20000
Teac	20000
Thomas	20000
Toshiba	20845, 21145, 21323
Zenith	20000, 20479, 21479

### TV/VCR/DVD Combination ※2, ※4

Akai	40899
Broksonic	40868
Emerson	40821
Funai	41334
Magnavox	40821
Panasonic	41362, 41462
RCA	41132
Sharp	40630
Superscan	40821
Sylvania	40821
Toshiba	41045
Sharp ※4	20807

### CABLE/PVR Combination ※1

Americast	00899
Digeo	01187
Freebox	01482
General Instrument	00476, 00810

Jerrold	00476, 00810
Motorola	00476, 00810, 01106, 01187, 01376
Nokia	01569
Pace	00237, 01877
Pioneer	00877, 01877
RCA	01256
Scientific Atlanta	00877, 01877
Sony	01006
Supercable	00276
Thomson	01256
Zenith	00899

### DBS/PVR Combination ※1

@sat	01300
Atsat	01300
British Sky Broadcasting	01175
Canal Satellite	01339
Comag	01412
Digiturk	01076
DirecTV	00099, 00392, 00639, 01076, 01142, 01377, 01392, 01442, 01443, 01444, 01640
Dish Network System	00775, 01505
Dishpro	00775, 01505
Dream Multimedia	01237
Echostar	00610, 00775, 01170, 01505
Euro1	01278
Expressvu	00775
Force	01194
Foxtel	01356
GbSAT	01214
Grundig	01150
Hughes Network Systems	01142, 01442, 01443, 01444
Humax	01176, 01427, 01568



Hyundai	01159
JVC	01170
Kathrein	01221, 01561
Maximum	01334
Motorola	00869
Nokia	01310, 01311
Opentel	01412
Pace	01423, 01623
Panasonic	01320
Philips	00099, 01142, 01442
Proscan	00392
RCA	01392
Rebox	01214
Sagem	01253, 01307
Samsung	01442
SKY	01175, 01848
Skyplus	01412
Sony	00639, 01640
Star Choice	00869
Strong	01158, 01300
Thomson	01900
Topfield	01206, 01545
TPS	01253, 01307
Zehnder	01075, 01412

- ※1 These preset codes can be recorded in the SAT/CBL mode.
- ※1 Ces codes de présélection peuvent être enregistrés en mode SAT/CBL.
- ※2 These preset codes can be recorded in the DVD mode.
- ※2 Ces codes de présélection peuvent être enregistrés en mode DVD.
- ※3 These preset codes can be recorded in the TV mode.
- ※3 Ces codes de présélection peuvent être enregistrés en mode TV.
- ※4 This preset code can be recorded in the VCR mode.
- ※4 Ces codes de présélection peuvent être enregistrés en mode VCR.

- \*[ ] : Preset codes set upon shipment from the factory.
- \*[ ] : Les codes pré-réglés diffèrent en fonction des livraisons de l'usine.

DVD preset codes / Codes pré-réglés DVD			
	41470 (default / défaut)	40490	
DENON Model No. / Modèle numéro	DVD-555	DVD-2910	DVD-800
	DVD-755	DVD-3800	DVD-1600
	DVD-900	DVD-3910	DVD-2000
	DVD-910	DVD-5900	DVD-2500
	DVD-955	DVD-5910	DVD-3000
	DVD-1000	DVD-9000	DVD-3300
	DVD-1200	DVM-715	
	DVD-1500	DVM-1800	
	DVD-1710	DVM-1805	
	DVD-1910	DVM-1815	
	DVD-2200	DVM-2815	
	DVD-2800	DVM-4800	
	DVD-2800II		
	DVD-2900		

**DENON**  
TOKYO, JAPAN  
[www.denon.com](http://www.denon.com)

Denon Brand Company, D&M Holdings Inc.  
Printed in Japan 00D 511 4413 009