

DENON

AVR-X2000

INTEGRATED NETWORK AV RECEIVER

Owner's Manual

[Front panel](#)[Display](#)[Rear panel](#)[Remote](#)[Index](#)

You can print more than one page of a PDF onto a single sheet of paper.

Contents

Accessories	6
Inserting the batteries.....	7
Operating range of the remote control unit.....	7
Features	8
High quality sound.....	8
High performance.....	8
Easy operation.....	9

Part names and functions

Front panel	10
Display	13
Rear panel	15
Remote control unit	17

Connections

Speaker connection	20
Speaker installation.....	20
Speaker connection.....	23
Connecting a TV	29
Connection 1 : TV equipped with an HDMI connector and compatible with the ARC (Audio Return Channel).....	30
Connection 2 : TV equipped with an HDMI connector.....	31

Connecting a playback device	32
Connecting a set-top box (Satellite tuner/cable TV).....	33
Connecting a DVD player.....	34
Connecting a video camcorder or other device.....	35
Connecting an iPod or USB memory device to the USB port	36
Connecting an FM antenna	38
Connecting to a home network (LAN)	39
Connecting the power cord	40

Playback

Basic operation	42
Turning the power on.....	42
Selecting the input source.....	42
Adjusting the master volume.....	43
Turning off the sound temporarily.....	43
Playing a DVD player/Blu-ray Disc player.....	43
Playing an iPod	44
Listening to music on an iPod.....	45
iPod Browse Mode settings.....	46
Performing repeat playback.....	47
Performing random playback.....	47
Playing a USB memory device	48
Playing files stored on USB memory devices.....	49



Listening to FM broadcasts	<u>51</u>	Listening to Spotify	<u>77</u>
Listening to FM broadcasts.....	<u>52</u>	Listening to Spotify	<u>77</u>
Tuning in by entering the frequency (Direct Tune).....	<u>53</u>	Adding to the FAVORITE STATION button	<u>81</u>
RDS search	<u>54</u>	Playing back content added to the FAVORITE STATION button.....	<u>82</u>
PTY search	<u>54</u>	AirPlay function	<u>83</u>
TP search	<u>55</u>	Playing songs from your iPhone, iPod touch or iPad.....	<u>83</u>
Radio Text	<u>56</u>	Playing iTunes music with this unit.....	<u>84</u>
Changing the tuning mode (Tune Mode)	<u>56</u>	Selecting multiple speakers (devices)	<u>84</u>
Listening to preset stations.....	<u>56</u>	Perform iTunes playback operations with the remote control unit of this unit.....	<u>85</u>
Presetting the current broadcast station (Preset Memory).....	<u>57</u>	Convenience functions	<u>86</u>
Tuning in to stations and presetting them automatically (Auto Preset Memory).....	<u>58</u>	Performing repeat playback	<u>87</u>
Specify a name for the preset broadcast station (Preset Name) ..	<u>58</u>	Performing random playback	<u>87</u>
Skipping preset broadcast stations (Preset Skip)	<u>59</u>	Registering to Favorites	<u>88</u>
Cancelling preset skip	<u>59</u>	Playing back content added in "Save to Favorites"	<u>88</u>
Listening to Internet Radio	<u>60</u>	Deleting content added to favorites.....	<u>89</u>
Listening to Internet Radio.....	<u>61</u>	Searching content with keywords (Text Search)	<u>89</u>
Playing the last played Internet Radio station	<u>62</u>	Playing back music and a favorite picture at the same time (Slideshow).....	<u>90</u>
Using vTuner to add Internet Radio stations to favorites.....	<u>63</u>	Setting the Slideshow Interval	<u>91</u>
Playing back files stored on a PC and NAS	<u>64</u>	Displaying your desired video during audio playback (Video Select)	<u>91</u>
Applying media sharing settings	<u>65</u>	Adjusting the picture quality for your viewing environment (Picture Mode).....	<u>92</u>
Playing back files stored on a PC and NAS	<u>66</u>	Playing the same music in all zones (All Zone Stereo)	<u>93</u>
Listening to Last.fm	<u>68</u>	Selecting a sound mode	<u>94</u>
Listening to Last.fm	<u>69</u>	Selecting a sound mode.....	<u>95</u>
Log Out	<u>72</u>	Direct playback.....	<u>96</u>
Viewing photographs on the Flickr site	<u>73</u>	Pure Direct playback	<u>96</u>
Viewing photographs shared by particular users	<u>74</u>		
Viewing all photographs on Flickr.....	<u>76</u>		



HDMI control function	<u>105</u>
Setting procedure.....	<u>105</u>
Sleep timer function	<u>106</u>
Using the sleep timer.....	<u>106</u>
Quick select function	<u>107</u>
Calling up the Quick Select.....	<u>107</u>
Changing the settings.....	<u>107</u>
Web control function	<u>108</u>
Controlling the unit from a web control.....	<u>108</u>
Playback in ZONE2 (Separate room)	<u>110</u>
Connecting ZONE2.....	<u>110</u>
Playback in ZONE2.....	<u>112</u>

Settings

Menu map	<u>114</u>
Menu operation.....	<u>120</u>
Inputting characters	<u>121</u>
Keyboard screen.....	<u>121</u>
Audio	<u>122</u>
Dialog Level.....	<u>122</u>
Subwoofer Level.....	<u>122</u>
Surround Parameter.....	<u>123</u>
Tone.....	<u>126</u>
Restorer.....	<u>126</u>
Audio Delay.....	<u>127</u>
Volume.....	<u>127</u>
Audyssey.....	<u>128</u>
Graphic EQ.....	<u>130</u>

Video	<u>131</u>
Picture Adjust.....	<u>131</u>
HDMI Setup.....	<u>132</u>
Output Settings.....	<u>134</u>
On Screen Display.....	<u>136</u>
TV Format.....	<u>136</u>
Inputs	<u>137</u>
Input Assign.....	<u>137</u>
Source Rename.....	<u>139</u>
Hide Sources.....	<u>139</u>
Source Level.....	<u>139</u>
Input Select.....	<u>140</u>
Speakers	<u>141</u>
Audyssey® Setup	<u>141</u>
Procedure for speaker settings (Audyssey® Setup).....	<u>143</u>
Error messages.....	<u>148</u>
Retrieving Audyssey® Setup settings.....	<u>149</u>
Manual Setup	<u>150</u>
Amp Assign.....	<u>150</u>
Speaker Config.....	<u>151</u>
Distances.....	<u>153</u>
Levels.....	<u>153</u>
Crossovers.....	<u>154</u>
Bass.....	<u>155</u>
Front Speaker Setup.....	<u>155</u>



Network	<u>156</u>
Information	<u>156</u>
IP Control	<u>156</u>
Friendly Name	<u>156</u>
Settings	<u>157</u>
Diagnostics	<u>158</u>
Maintenance Mode	<u>159</u>
General	<u>160</u>
Language	<u>160</u>
ZONE2 Setup	<u>160</u>
Zone Rename	<u>161</u>
Quick Select Names	<u>161</u>
Auto Standby	<u>162</u>
Front Display	<u>162</u>
Information	<u>162</u>
Usage Data	<u>164</u>
Firmware	<u>164</u>
Setup Lock	<u>166</u>
Specifying the zone used with the remote control unit	<u>167</u>

Tips

Contents	<u>168</u>
Tips	<u>169</u>
Troubleshooting	<u>171</u>
Resetting factory settings	<u>183</u>

Appendix

About HDMI	<u>184</u>
Video conversion function	<u>187</u>
Playing back USB memory devices	<u>189</u>
Playing back files stored on PC or NAS	<u>190</u>
Playing back Internet Radio	<u>191</u>
Personal memory plus function	<u>191</u>
Last function memory	<u>191</u>
Sound modes and channel output	<u>192</u>
Sound modes and surround parameters	<u>193</u>
Types of input signals, and corresponding sound modes	<u>196</u>
Explanation of terms	<u>199</u>
Trademark information	<u>205</u>
Specifications	<u>207</u>
Index	<u>209</u>
License	<u>212</u>



Thank you for purchasing this Denon product. To ensure proper operation, please read this owner's manual carefully before using the product. After reading this manual, be sure to keep it for future reference.

Accessories

Check that the following parts are supplied with the product.

① Getting Started



② CD-ROM (Owner's Manual)

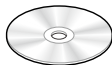

③ Safety Instructions

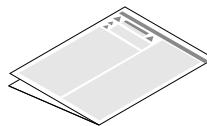

④ Power cord

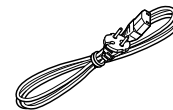

⑤ Remote control unit (RC-1183)

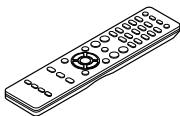

⑥ R03/AAA batteries



⑦ FM indoor antenna

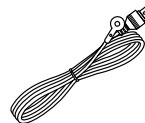

⑧ Setup and measurement microphone (ACM1HB)



⑨ Cable label

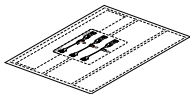

Inserting the batteries

- 1 Remove the rear lid in the direction of the arrow and remove it.

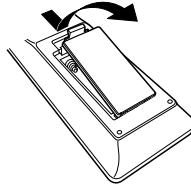

- 2 Load the two batteries properly as indicated by the \oplus and \ominus marks in the battery compartment.

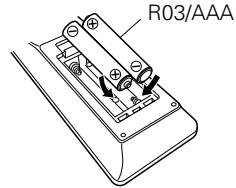

- 3 Put the rear cover back on.

NOTE

- When inserting the batteries, be sure to do so in the proper direction, following the \oplus and \ominus marks in the battery compartment.
- To prevent damage or leakage of battery fluid:
 - Do not use a new battery together with an old one.
 - Do not use two different types of batteries.
- Remove the batteries from the remote control unit if it will not be in use for long periods.
- If the battery fluid should leak, carefully wipe the fluid off the inside of the battery compartment and insert new batteries.

Operating range of the remote control unit

Point the remote control unit at the remote sensor when operating it.

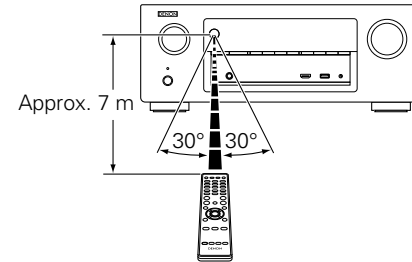

Features

High quality sound

- **With discrete circuit technology, the power amplifier provides identical quality for all 7-channels (125 Watts x 7-channels)**

For optimum realism and stunning dynamic range, the power amplifier section features discrete power devices (not integrated circuitry).

By using high current, high power discrete power devices, the amplifier is able to easily drive high quality speakers.

High performance

- **Digital video processor upscales analog video signals (SD resolution) to HD (720p/1080p) and 4K (👉 [page 184](#))**

This unit features a sophisticated video processor that can upscale standard definition (SD) analog video content from legacy sources such as a VCR to HD and is able to output at 4K Ultra HD resolution (3840 x 2160 pixels) for compatibility with newly available high 4K TVs.

- **Supports Internet Radio, music, and photograph streaming Supports AirPlay® (👉 [page 83](#))**

You can enjoy a wide variety of content, including listening to Internet Radio, playing audio files stored on your PC, and displaying photographs stored on your PC on our television.

This unit also supports Apple AirPlay which lets you stream your music library from an iPhone®, iPad®, iPod touch® or iTunes®.

- **Compatible with “Denon Remote App” for performing basic operations of the unit with an iPad, iPhone or Android* smartphone** “Denon Remote App” is application software that allows you to perform basic operations with an iPad, iPhone, Android smartphone or Android tablet such as turning the unit ON/OFF, controlling the volume, and switching the source.

* Download the appropriate “Denon Remote App” for iOS and Android devices. This unit needs to be connected to your LAN and the iPhone/iPod touch or other device needs to be connected to the same network by Wi-Fi (wireless LAN).

- **HDMI connections enable quick connection to various digital AV devices (7 inputs, 1 output)**

The unit is equipped with 7 HDMI input connectors for connecting devices with HDMI connectors, such as a Blu-ray Disc player, game console, HD digital camcorder, HDTVs, etc.

- **Supports HDMI (3D, ARC, Deep Color, “x.v.Color”, Auto Lip Sync, 4K) and HDMI control function (👉 [page 184](#))**

Advanced HDMI features are supported, including 3D passthrough, Audio Return Channel, Auto Lip Sync, Deep Color and “x.v.Color”, and HDMI CEC control functions. If a 4K digital video signal is input, it is passed through the unit unchanged, and the GUI overlay will adjust the resolution accordingly.



- **Direct play for iPod and iPhone via USB** (👉 [page 36](#))

Music data from an iPod or iPhone can be played back if you connect the USB cable supplied with the iPod via the USB port of this unit, and also an iPod and iPhone can be controlled with the remote control that comes with this unit.

- **Multi-Room audio**

Enjoy the same music in your home theater and another room at the same time (👉 [page 93](#)).

Easy operation

- **“Setup Assistant” provides easy-to-follow setup instructions**

First select the language when prompted. Then simply follow the instructions displayed on the TV screen to set up the speakers, network, etc.

- **Easy to use Graphical User Interface**

This unit is equipped with an easy to see Graphical User Interface that uses menu displays and features colorful icons and easy to understand controls for maximum ease of use.



Part names and functions

Front panel

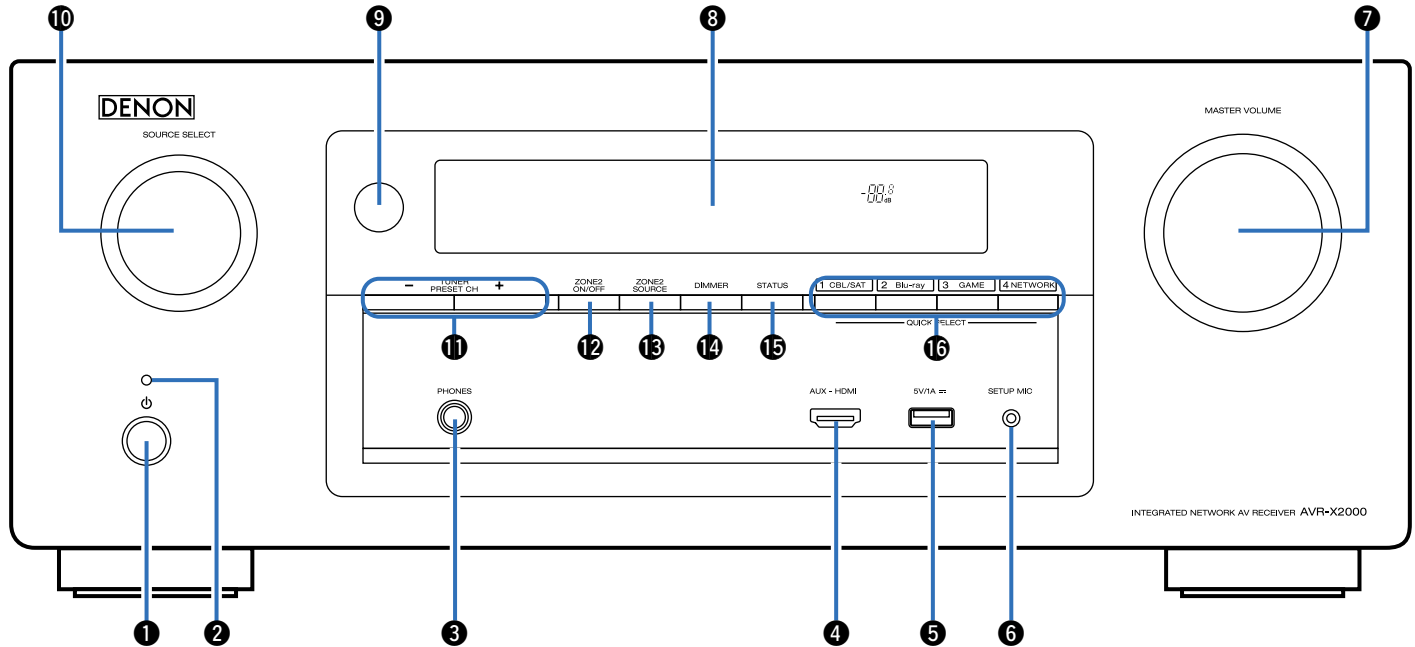

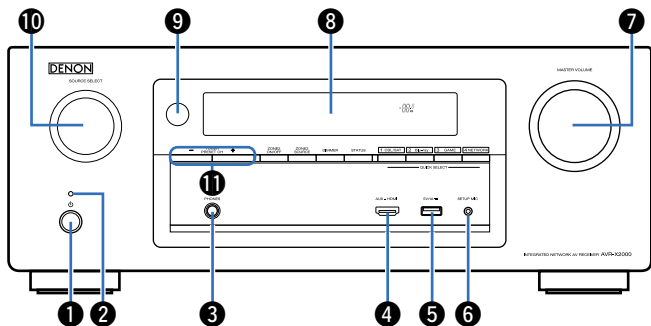

1 Power operation button (⏻)

This turns the power of MAIN ZONE on/off (standby) (☞ page 42).

2 Power indicator

This is lit as follows according to the power status:

- Power on : Green
- Normal standby : Off
- When “HDMI Pass Through” (☞ page 133) or “HDMI Control” (☞ page 133) is set to “On” : Red
- When “IP Control” (☞ page 156) is set to “Always On” : Red

3 Headphones jack (PHONES)

Used to connect headphones.

When the headphones are plugged into this jack, audio will no longer be output from the connected speakers.

NOTE

- To prevent hearing loss, do not raise the volume level excessively when using headphones.

4 AUX-HDMI connector

Used to connect devices such as video camcorders and game consoles (☞ page 35).

5 USB port

Used to connect USB storages (such as USB memory devices) and the USB cable supplied with iPod (☞ page 36).

6 SETUP MIC jack

Used to connect the supplied Setup and measurement microphone (☞ page 144).

7 MASTER VOLUME knob

This adjusts the volume level (☞ page 43).

8 Display

This displays various pieces of information (☞ page 13).

9 Remote control sensor

This receives signals from the remote control unit (☞ page 7).

10 SOURCE SELECT knob

This selects the input source (☞ page 42).

11 Tuner preset buttons (TUNER PRESET CH +, -)

These select preset FM radio stations (☞ page 56).

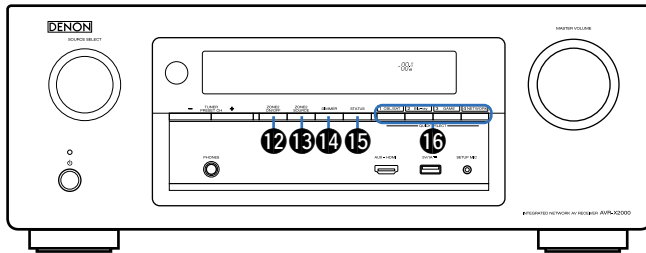

**12 ZONE2 ON/OFF button**

This turns the power of ZONE2 on/off (👉 [page 112](#)).

13 ZONE2 SOURCE button

This selects the input source for ZONE2 (👉 [page 112](#)).

14 DIMMER button

Each press of this switches the brightness of the display (👉 [page 162](#)).

15 STATUS button

Each press of this switches the status information that is shown on the display (👉 [page 46](#)).

16 QUICK SELECT buttons

With a single press of any of these buttons, you can call up various settings you've registered to each button such as the input source, volume level and sound mode settings (👉 [page 107](#)).



Display

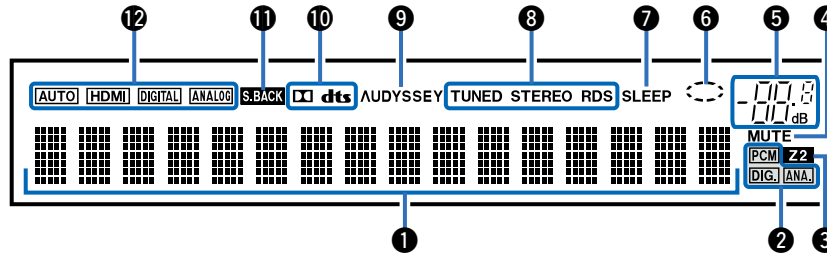

❶ Information display

The input source name, sound mode, setting values and other information are displayed here.

❷ Input signal indicators

❸ MULTI ZONE indicators

This lights up when ZONE2 (separate room) power is turned on ([page 112](#)).

❹ MUTE indicator

This blinks while the sound is muted ([page 43](#)).

❺ Master volume indicator

❻ Circle indicator

Circle indicator is displayed when the input source is “NETWORK” or “iPod/USB” when you are playing back music.

❼ Sleep timer indicator

This lights when the sleep mode is selected ([page 106](#)).

❽ Tuner reception mode indicators

These light according to the reception conditions when the input source is set to “TUNER”.

STEREO : In FM mode, this lights up when receiving stereo broadcasts.

TUNED : Lights up when the broadcast is properly tuned in.

RDS : Lights up when receiving RDS broadcasts.

❾ Audyssey® indicator

This indicator lights when the “MultEQ® XT” ([page 128](#)), “Dynamic EQ” ([page 128](#)) or “Dynamic Volume” ([page 129](#)) setting is set to other than “Off”.



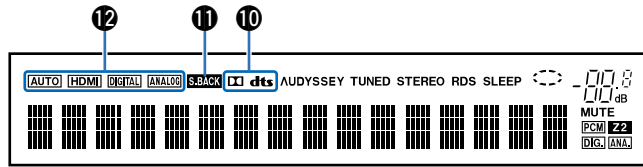

10 Decoder indicator

These light when Dolby or DTS signals are input or when the Dolby or DTS decoder is running.

11 Surround back indicator

This lights when audio signals are being output from the surround back speakers (🔗 [page 152](#)).

12 Input mode indicators

Set the audio input modes for the different input sources (🔗 [page 140](#)).



Rear panel

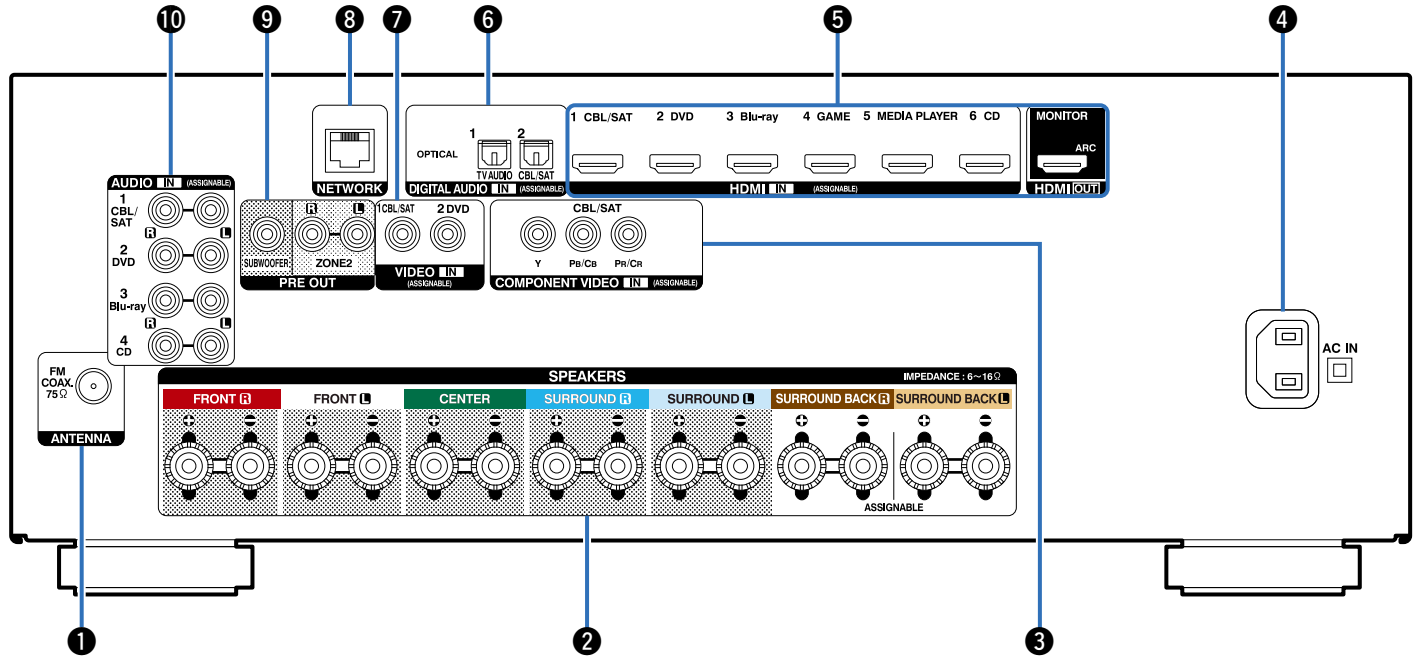

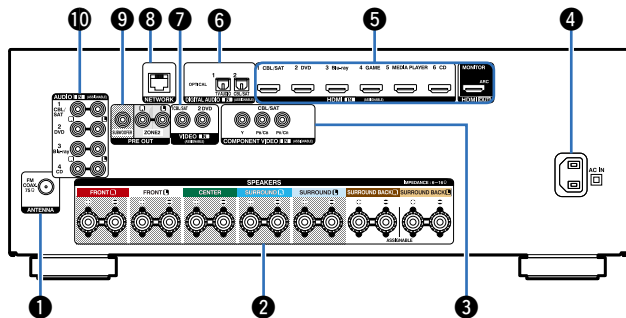

1 FM antenna terminals (ANTENNA)

Used to connect FM antennas (🔗 [page 38](#)).

2 Speaker terminals (SPEAKERS)

Used to connect speakers (🔗 [page 23](#)).

3 Component video connectors (COMPONENT VIDEO)

Used to connect devices equipped with component video connectors (🔗 [page 33](#)).

4 AC inlet (AC IN)

Used to connect the power cord (🔗 [page 40](#)).

5 HDMI connectors

Used to connect devices equipped with HDMI connectors (🔗 [page 30, 31, 33, 34](#)).

6 Digital audio connectors (DIGITAL AUDIO)

Used to connect devices equipped with digital audio connectors (🔗 [page 33](#)).

7 Video connectors (VIDEO)

Used to connect devices equipped with video connectors (🔗 [page 33, 34](#)).

8 Network connector (NETWORK)

Used to connect this unit to the network (🔗 [page 39](#)).

9 PRE OUT connectors

Used to connect a subwoofer with a built-in amplifier or an external power amplifier (🔗 [page 24, 111](#)).

10 Analog audio connectors (AUDIO)

Used to connect devices equipped with analog audio connectors (🔗 [page 33, 34](#)).

NOTE

- Do not touch the inner pins of the connectors on the rear panel. Electrostatic discharge may cause permanent damage to the unit.



Remote control unit

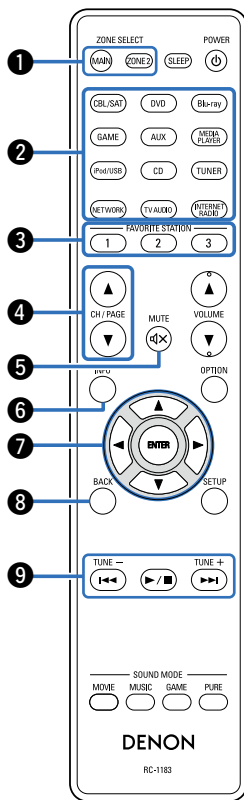

1 ZONE SELECT buttons (MAIN, ZONE2)

These switch the zone (MAIN ZONE, ZONE2) that is operated through the remote control unit (☞ page 112, 120).

2 Input source select buttons

These select the input source (☞ page 42, 112).

3 FAVORITE STATION buttons (1 – 3)

With a single press of these, you can call up registered radio stations and contents (☞ page 81).

4 Channel/page search buttons (CH/PAGE ▲▼)

These select preset radio stations or switch pages (☞ page 56).

5 MUTE button (M)

This mutes the output audio (☞ page 43, 113).

6 Information button (INFO)

This displays the status information on the TV screen (☞ page 163).

7 Cursor buttons (▲▼◀▶)

These select items (☞ page 120).

8 BACK button

This returns to the previous screen (☞ page 120).

9 System buttons

These perform playback related operations (☞ page 44).

- Skip buttons (◀◀, ▶▶)
- Play/pause button (▶/||)

Tuning up / Tuning down buttons (TUNE +, -)

These operate the tuner (☞ page 52).



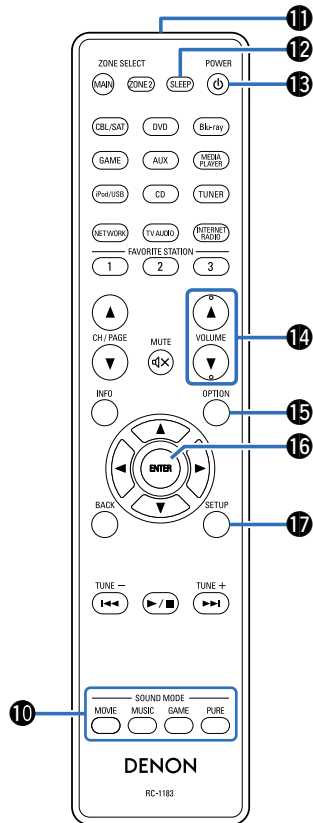

10 SOUND MODE buttons

These select the sound mode ([page 94](#)).

- MOVIE button
- MUSIC button
- GAME button
- PURE button

11 Remote control signal transmitter

This transmits signals from the remote control unit ([page 7](#)).

12 SLEEP button

This sets the sleep timer ([page 106](#)).

13 POWER button (⏻)

This turns the power on/off ([page 42, 112](#)).

14 VOLUME buttons (▲▼)

These adjust the volume level ([page 43, 112](#)).

15 OPTION button

This displays the option menu on the TV screen ([page 86](#)).

16 ENTER button

This determines the selection ([page 120](#)).

17 SETUP button

This displays the menu on the TV screen ([page 120](#)).



Connections

Speaker connection (👉 page 20)

Connecting a TV (👉 page 29)

Connecting a playback device (👉 page 32)

Connecting an iPod or USB memory device to the USB port (👉 page 36)

Connecting an FM antenna (👉 page 38)

Connecting to a home network (LAN) (👉 page 39)







Connecting the power cord (👉 page 40)

NOTE

- Do not plug in the power cord until all connections have been completed. However, when the "Setup Assistant" is running, follow the instructions in the "Setup Assistant" (📖 page 7) screen for making connections. (During "Setup Assistant" operation, the input/output connectors do not conduct current.)
- Do not bundle power cords together with connection cables. Doing so can result in noise.

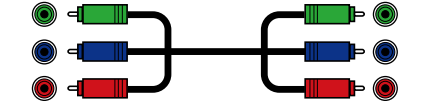
■ Cables used for connections

Provide necessary cables according to the devices you want to connect.

Speaker cable	
Subwoofer cable	
HDMI cable	
Component video cable	
Video cable	
Optical cable	
Audio cable	
LAN cable	



Speaker connection

Install speakers and connect them to this unit (☞ page 20, 23).

Speaker installation

Determine the speaker system depending on the number of speakers you are using and install each speaker and subwoofer in the room. Here, we explain how to install the speakers using a typical example.

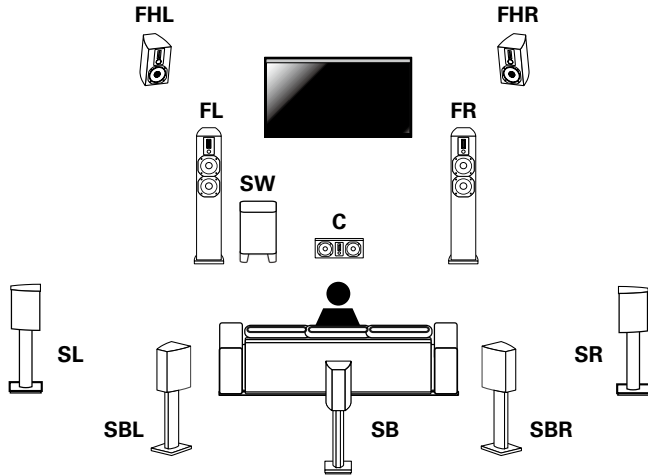

FL/FR : Place the FRONT left and right speakers an equal distance from the main listening position. The distance between each speaker and your TV should also be the same.

C : Place the CENTER speaker in between the front speakers and above or below your TV.

SL/SR : Place the SURROUND left and right speakers an equal distance to the left and right sides of the main listening position. If you don't have Surround Back speakers, move the surround speakers slightly behind your listening position.

SBL/SBR (SB) : Place the SURROUND BACK left and right speakers an equal distance from the main listening position and directly behind the main listening position. If you only have one Surround Back speaker, center it.

FHL/FHR : Place the FRONT HEIGHT left and right speakers just outside of the front left and right speakers. Mount them as close to the ceiling as possible and aim them towards the main listening position.

SW : Place the SUBWOOFER at a convenient location near the front speakers.





- This unit is compatible with Dolby Pro Logic IIz (see page 200) which offers an even wider and deeper surround sensation. When using Dolby Pro Logic IIz, install front height speakers.
- Use the illustration below as a guide for how high each speaker should be installed. The height does not need to be exactly the same.

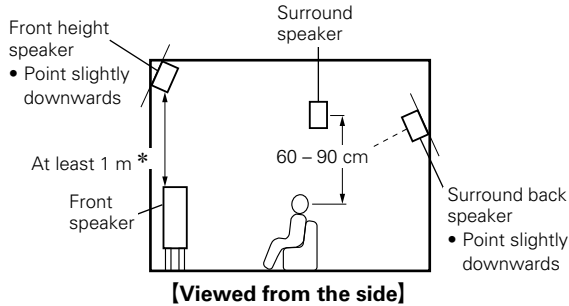

* Recommended for Dolby Pro Logic IIz

NOTE

- You cannot have audio output from the surround back speakers and front height speakers simultaneously.

■ When 7.1/6.1-channel speakers are installed using surround back speakers

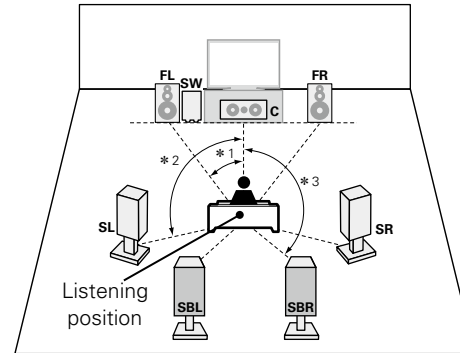

- *1 22° - 30°
- *2 90° - 110°
- *3 135° - 150°



- When using a single surround back speaker, place it directly behind the listening position.

[Speaker abbreviations]

FL	Front speaker (L)	SBL	Surround back speaker (L)
FR	Front speaker (R)	SBR	Surround back speaker (R)
C	Center speaker	FHL	Front height speaker (L)
SW	Subwoofer	FHR	Front height speaker (R)
SL	Surround speaker (L)		
SR	Surround speaker (R)		



■ When 7.1-channel speakers are installed using front height speakers

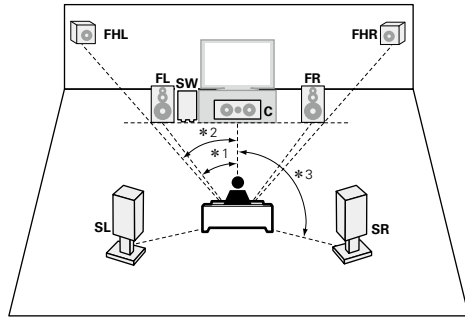

- *1 22° - 30°
- *2 22° - 45°
- *3 90° - 110°

■ When 5.1-channel speakers are installed

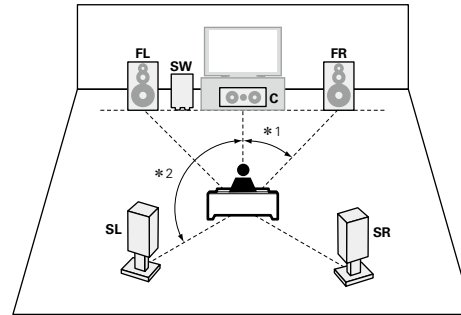

- *1 22° - 30°
- *2 120°



Speaker connection

Here we connect the speakers in the room to this unit.
This section explains how to connect them using typical examples.

NOTE

- Disconnect this unit's power plug from the power outlet before connecting the speakers. Also, turn off the subwoofer.
- Connect so that the speaker cable core wires do not protrude from the speaker terminal. The protection circuit may be activated if the core wires touch the rear panel or if the + and – sides touch each other (see page 203 "Protection circuit").
- Never touch the speaker terminals while the power cord is connected. Doing so could result in electric shock. When the "Setup Assistant" is running, follow the instructions in the "Setup Assistant" screen for making connections. (Power is not supplied to the speaker terminals while the "Setup Assistant" is running.)
- Use speakers with an impedance of 6 – 16 Ω /ohms.

■ Connecting the speaker cables

Carefully check the left (L) and right (R) channels and + (red) and – (black) polarities on the speakers being connected to this unit, and be sure to connect the channels and polarities correctly.

- 1 Peel off about 10 mm of sheathing from the tip of the speaker cable, then either twist the core wire tightly or terminate it.**



- 2 Turn the speaker terminal counterclockwise to loosen it.**

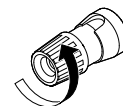

- 3 Insert the speaker cable's core wire to the hilt into the speaker terminal.**

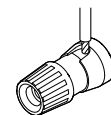

- 4 Turn the speaker terminal clockwise to tighten it.**

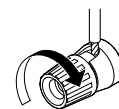

■ Connecting the subwoofer

Use a subwoofer cable to connect the subwoofer.

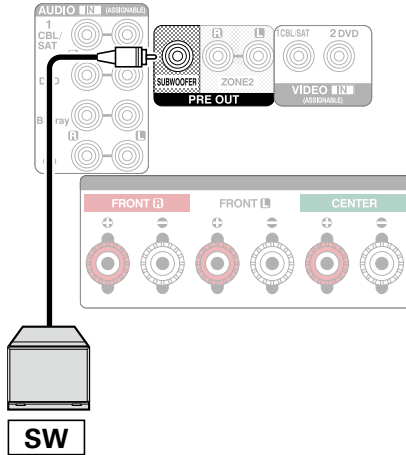

■ About the speaker cable label (supplied) for channel identification

The channel display section for speaker terminals on the rear panel is color-coded for each channel to be identifiable.

Speaker terminals	Color
FRONT L	White
FRONT R	Red
CENTER	Green
SURROUND L	Light blue
SURROUND R	Blue
SURROUND BACK L	Beige
SURROUND BACK R	Brown

Attach the speaker cable label for each channel to its speaker cable as shown in the diagram.

Then, make connection so that the color of the speaker terminal matches that of the speaker cable label.

[How to attach the speaker cable label]

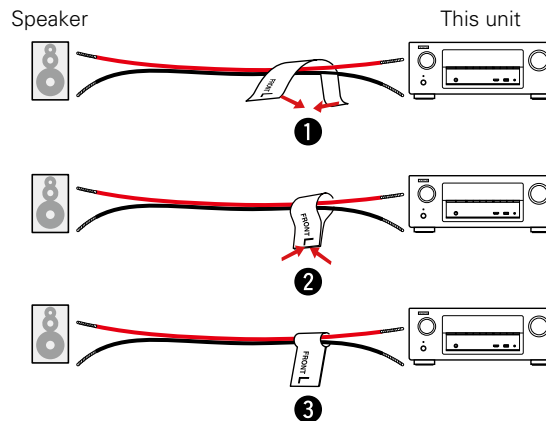

■ Standard speaker connection

The figure below shows an example of standard speaker connection.

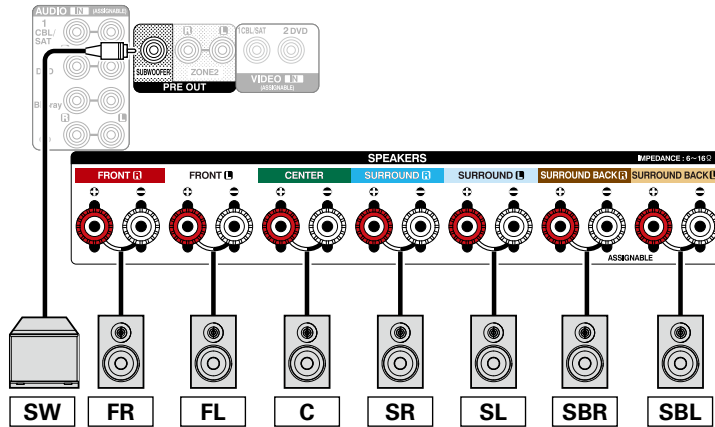

- When using this connection, also set "Assign Mode" in the menu to "Surround Back" (see page 150).
- When using a single surround back speaker, connect it to the SURROUND BACK L terminal.



■ About the front height or front B speaker connections

The speaker connected to the SURROUND BACK terminal differs depending on the mode selected for “Assign Mode” (☞ [page 150](#)) in the menu.

- For how to connect the front, center, and surround speaker and the subwoofer to this unit, see “Standard speaker connection” (☞ [page 26](#)).

[Connecting the front height speaker]

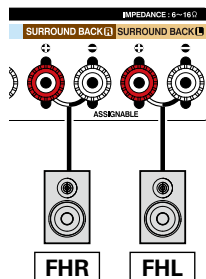

- When using this connection, also set “Assign Mode” in the menu to “Front Height” (☞ [page 150](#)).

[Connecting the front B speaker]

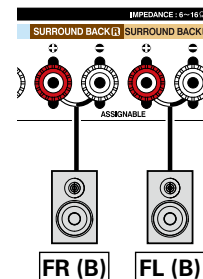

- When using this connection, also set “Assign Mode” in the menu to “Front B” (☞ [page 150](#)).



■ About the Bi-amp connection

Some audiophile loudspeakers can be connected to an amplifier with two separate amp-to-speaker connections per each speaker. One amplifier channel's output is hooked up to the speaker's bass driver (woofer), while the other amplifier drives the upper range transducers (tweeter, or in some cases midrange and tweeter). This connection method has one amplifier channel driving one half of the bi-amp speaker, and avoids electrical interference between the speaker's bass and treble drivers and the driving amplifier channels. You can assign 4 amp channels to connect to one pair of bi-amp capable speakers. Bi-amp capable speakers always have two sets of speaker input connector pairs, one for the bass range and one for the treble range. If you're unsure about whether or not your speakers are bi-amp capable, consult the owner's manual that came with the speakers.

- For how to connect the center, and surround speaker and the subwoofer to this unit, see "Standard speaker connection" (🔗 [page 26](#)).

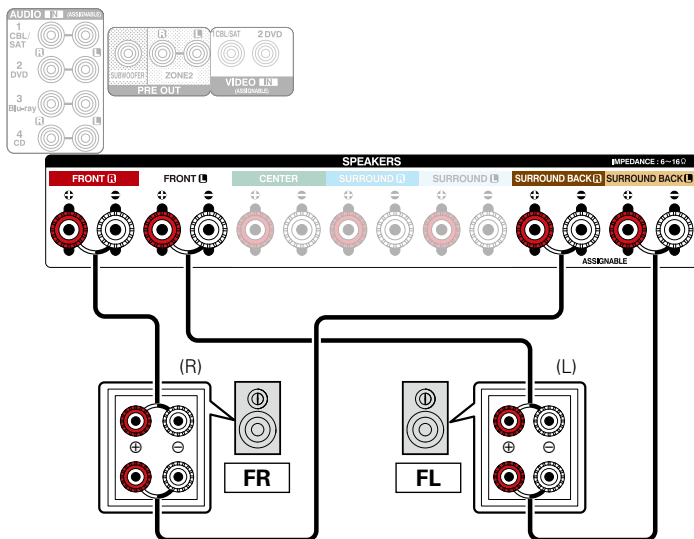

- When using this connection, also set "Assign Mode" in the menu to "Bi-AMP" (🔗 [page 150](#)).

NOTE

- When making bi-amp connections, be sure to remove the short-circuiting plate or wire between the speaker's woofer and tweeter terminals.



Connecting a TV

Connect a TV to this unit so that the input video is output to the TV. You can also enjoy audio from the TV on this unit.

How to connect a TV depends on the connectors and functions equipped on the TV.

ARC function plays TV audio on this unit by sending the TV audio signal to this unit via HDMI cable.

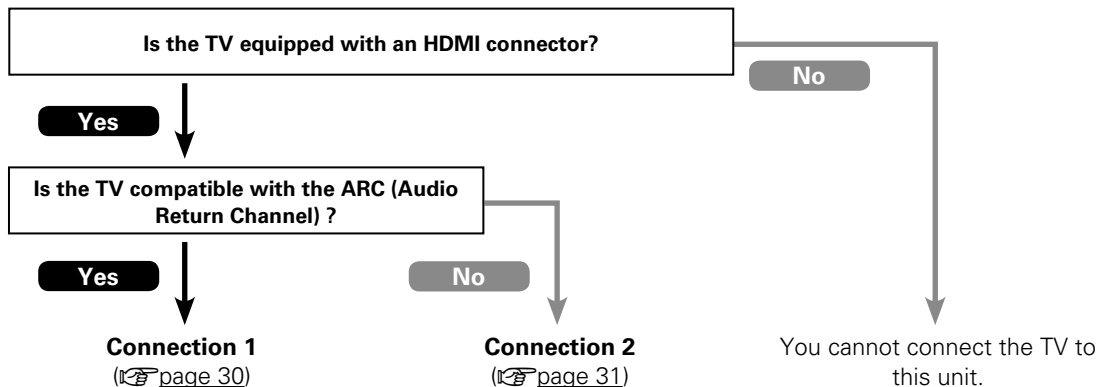

Connection 1 : TV equipped with an HDMI connector and compatible with the ARC (Audio Return Channel)

Use an HDMI cable to connect a TV that is compatible with the ARC function to this unit.
Set "HDMI Control" (see page 133) to "On" when using a TV that supports the ARC function.

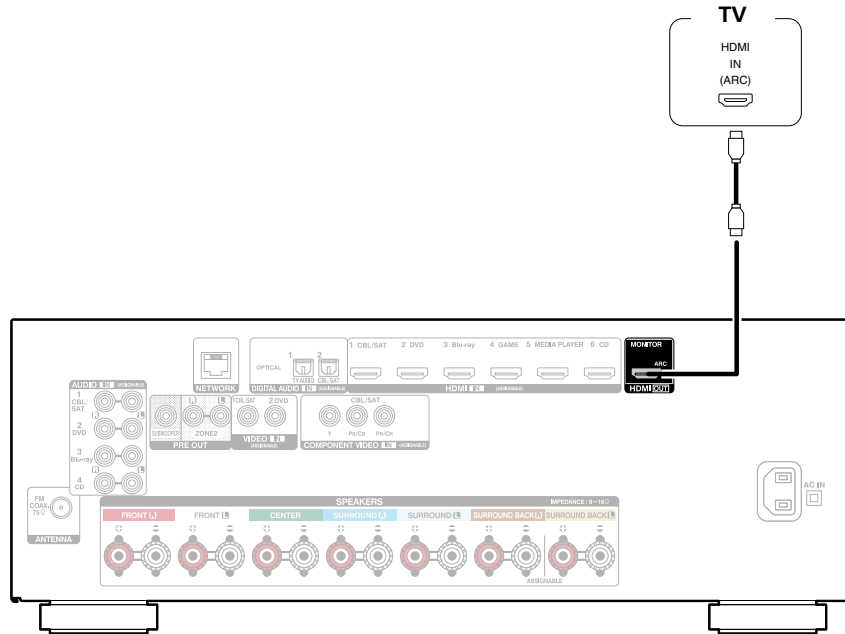

Connection 2 : TV equipped with an HDMI connector

Use an HDMI cable to connect the TV to this unit.

To listen to audio from TV on this unit, use an optical cable to connect the TV to this unit.

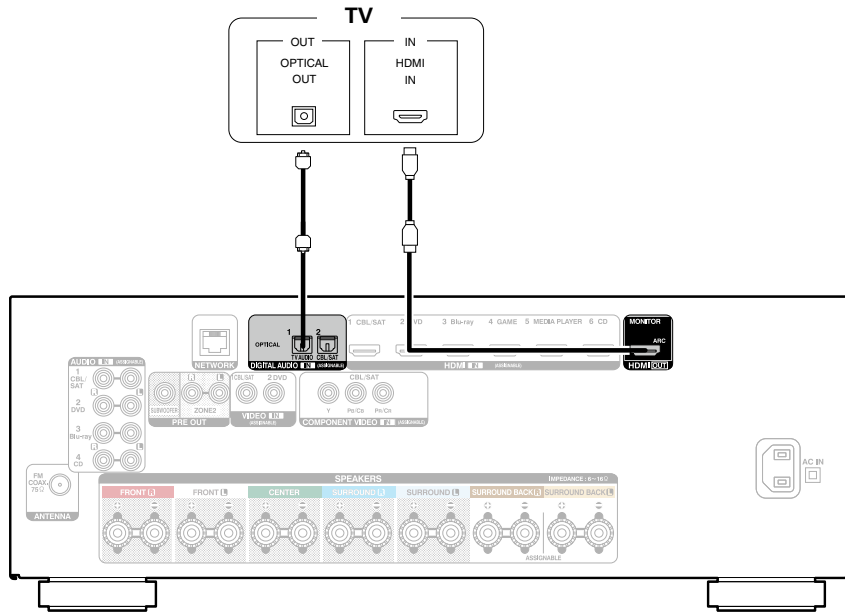

- To output audio signals that are input from the HDMI input connector to a TV connected via HDMI, set "HDMI Audio Out" (see page 132) to "TV".





Connecting a playback device

This unit is equipped with three types of video input connectors (HDMI, component video and composite video) and one type of video output connector (HDMI).

Select input connectors on this unit according to the connectors equipped on the device you want to connect.

If the device connected to this unit is equipped with an HDMI connector, it is recommended to use HDMI connections.

In the HDMI connection, audio and video signals can be transmitted through a single HDMI cable.

- Connecting a set-top box (Satellite tuner/cable TV) ( [page 33](#))
- Connecting a DVD player ( [page 34](#))
- Connecting a video camcorder or other device ( [page 35](#))



- Connect devices to this unit as indicated by the input sources printed on the audio/video input connectors of this unit.
- This unit can change the source that is assigned to the HDMI IN, DIGITAL AUDIO IN, COMPONENT VIDEO IN, VIDEO IN and AUDIO IN connectors.
How to change the source assigned to connectors ( [page 137](#) "Input Assign").



Connecting a set-top box (Satellite tuner/cable TV)

This explanation uses the connection with a satellite tuner/cable TV STB as an example.

Select input connectors on this unit according to the connectors equipped on the device you want to connect.

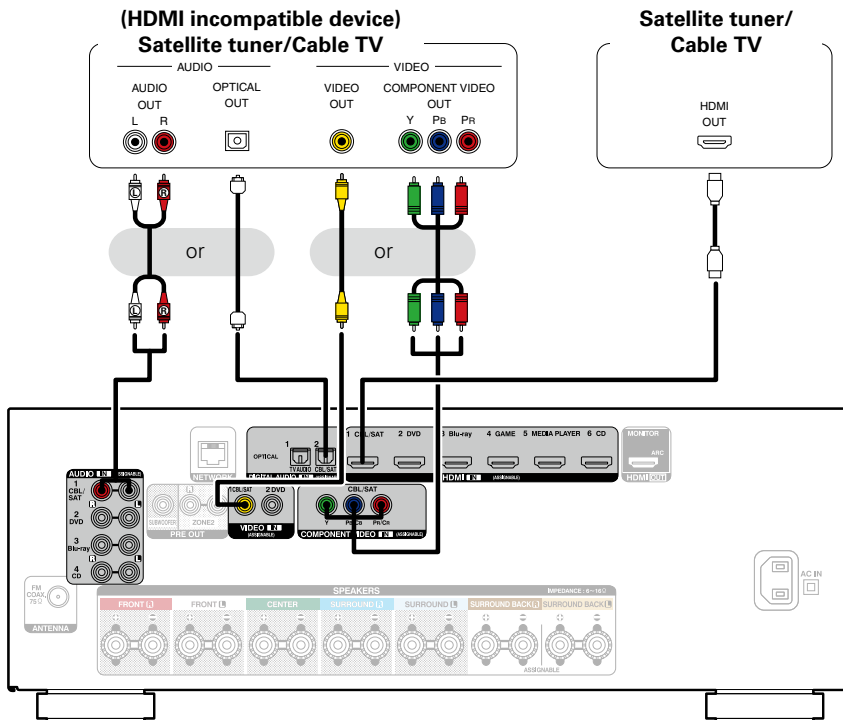

Connecting a DVD player

This explanation uses the connection with a DVD players as an example.
 Select input connectors on this unit according to the connectors equipped on the device you want to connect.

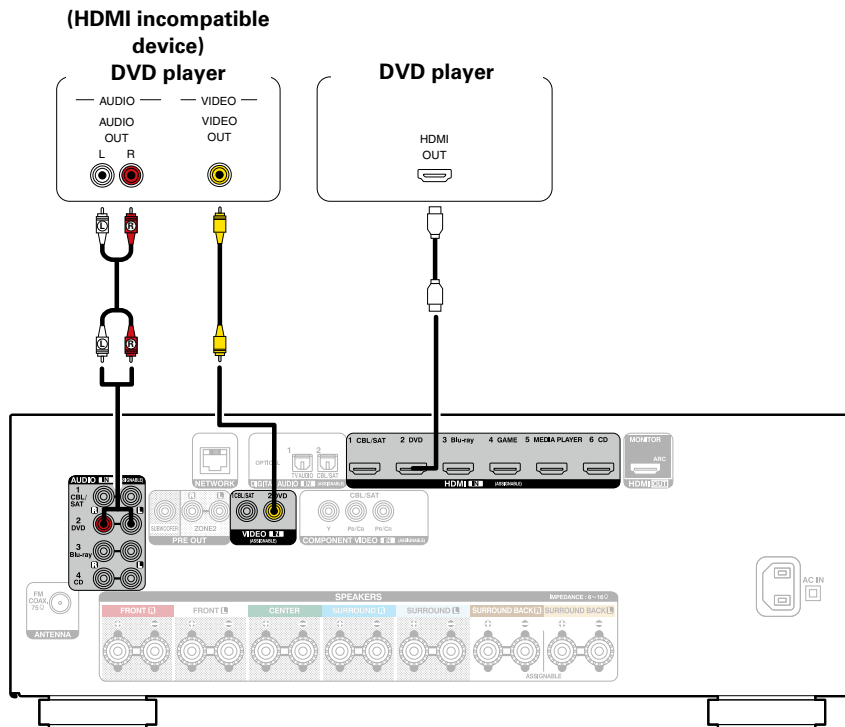

Connecting a video camcorder or other device

This explanation uses the connection with a video camcorders as an example.
Connect a playback device to this unit, such as a video camcorder or game console.

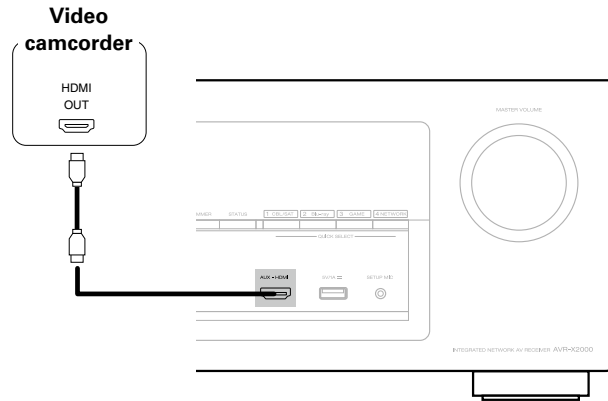

Connecting an iPod or USB memory device to the USB port

To connect an iPod to this unit, use the USB adapter cable that was supplied with the iPod.

For operating instructions see “Playing an iPod” (🔗 page 44) or “Playing a USB memory device” (🔗 page 48).

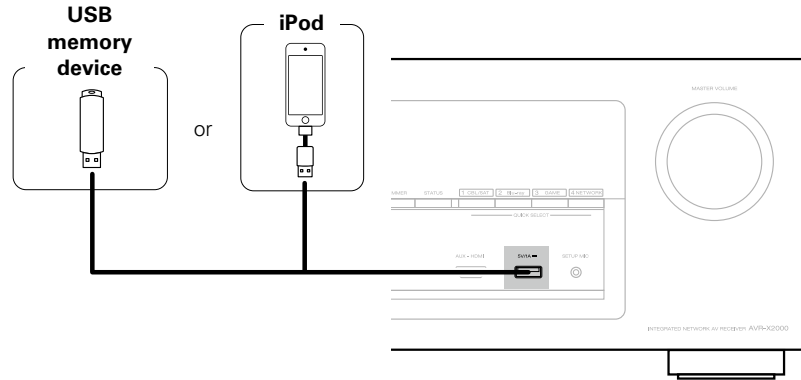

- Denon does not guarantee that all USB memory devices will operate or receive power. When using a portable USB hard disk drive (HDD) which came with an AC adapter, use that device's supplied AC adapter.

NOTE

- USB memory devices will not work via a USB hub.
- It is not possible to use this unit by connecting the unit's USB port to a PC via a USB cable.
- Do not use an extension cable when connecting a USB memory device. This may cause radio interference with other devices.



■ Supported iPod/iPhone models

• iPod classic



iPod classic
80GB



iPod classic
160GB (2007)



iPod classic
160GB (2009)

• iPod nano



iPod nano
3rd generation
(video)
4GB 8GB



iPod nano
4th generation (video)
8GB 16GB



iPod nano
5th generation (video camera)
8GB 16GB



iPod nano
6th generation
8GB 16GB



iPod nano
7th generation
16GB

• iPod touch



iPod touch
1st generation
8GB 16GB 32GB



iPod touch
2nd generation
8GB 16GB 32GB



iPod touch
3rd generation
32GB 64GB



iPod touch
4th generation
8GB 32GB 64GB



iPod touch
5th generation
32GB 64GB

• iPhone



iPhone
4GB 8GB 16GB



iPhone 3G
8GB 16GB



iPhone 3GS
8GB 16GB 32GB



iPhone 4
8GB 16GB 32GB



iPhone 4S
16GB 32GB 64GB



iPhone 5
16GB 32GB 64GB



Connecting an FM antenna

After connecting the antenna and receiving a broadcast signal (see page 52 “Listening to FM broadcasts”), fix the antenna with tape in a position where the noise level becomes minimal.

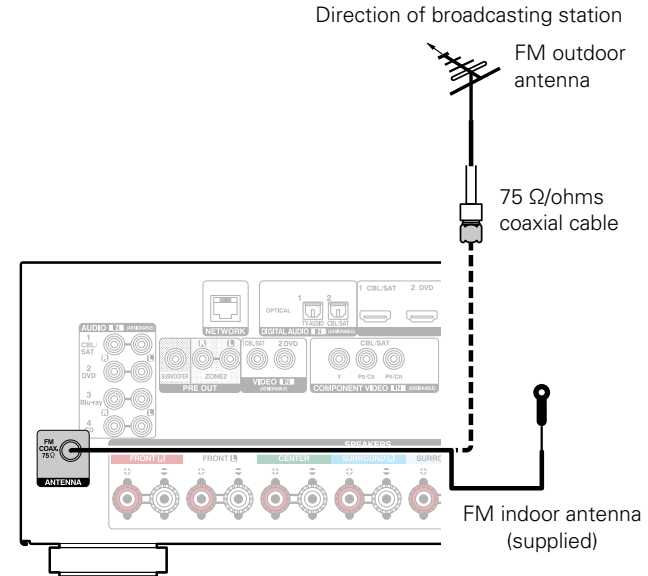

NOTE

- Do not connect two FM antennas simultaneously.
- If you are unable to receive a good broadcast signal, we recommend installing an outdoor antenna. For details, inquire at the retail store where you purchased the unit.



Connecting to a home network (LAN)

You can connect this unit to your home network (LAN) to perform various types of playbacks and operations as follows.

- Playback of network audio such as Internet Radio and from your media server(s)
- Playback of music content from online streaming services
- Using the Apple AirPlay function
- Operation on this unit via the network
- Firmware Update



- With this unit, it is possible to use the DHCP and Auto IP functions to make the network settings automatically.
- When using this unit connected to a network with no DHCP function, make the settings for the IP address, etc., at "Network" (☞ [page 156](#)).

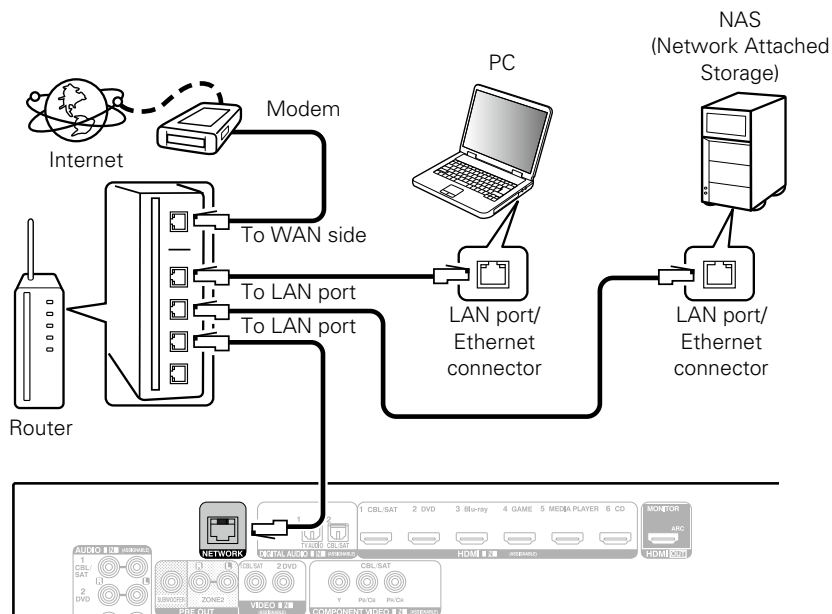

For connections to the Internet, contact an ISP (Internet Service Provider) or a computer shop.





- When using this unit, we recommend you use a router equipped with the following functions:
 - Built-in DHCP server
This function automatically assigns IP addresses on the LAN.
 - Built-in 100BASE-TX switch
When connecting multiple devices, we recommend a switching hub with a speed of 100 Mbps or greater.
- Use only a shielded STP or ScTP LAN cable which is easily available at electronics stores (CAT-5 or greater recommended).
- The normal shielded-type LAN cable is recommended. If a flat-type cable or unshielded-type cable is used, other devices could be affected by noise.

NOTE

- The types of routers that can be used depend on the ISP. Contact your ISP or a computer shop for details.
- This unit is not compatible with PPPoE. A PPPoE-compatible router is required if you have a contract for a type of line set by PPPoE.
- Do not connect an NETWORK connector directly to the LAN port/ Ethernet connector on your computer.

Connecting the power cord

After completing all the connections, insert the power plug into the power outlet.

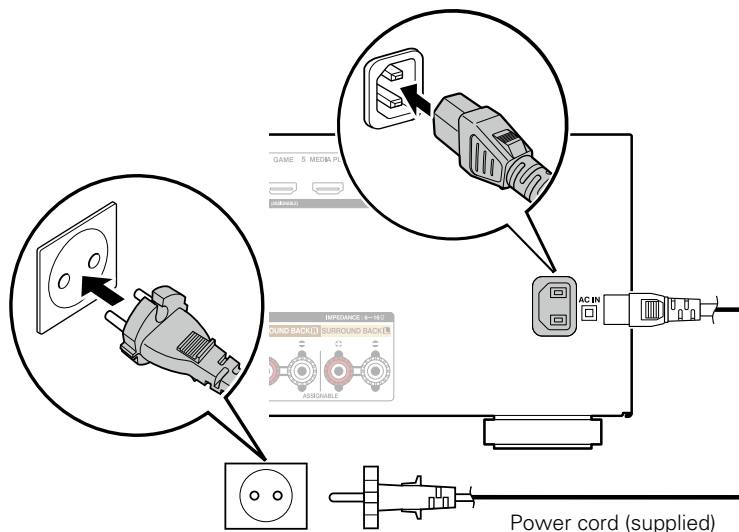

To household power outlet
(AC 230 V, 50/60 Hz)



Playback

Turning the power on (👉 page 42)

Selecting the input source (👉 page 42)

Adjusting the master volume (👉 page 43)

Turning off the sound temporarily (👉 page 43)

Playing a DVD player/Blu-ray Disc player (👉 page 43)

Playing an iPod (👉 page 44)

Playing a USB memory device (👉 page 48)

Listening to FM broadcasts (👉 page 51)

Listening to Internet Radio (👉 page 60)

Playing back files stored on a PC and NAS (👉 page 64)

Listening to Last.fm (👉 page 68)

Viewing photographs on the Flickr site (👉 page 73)

Listening to Spotify (👉 page 77)

Adding to the FAVORITE STATION button (👉 page 81)

AirPlay function (👉 page 83)

Convenience functions (👉 page 86)

Selecting a sound mode (👉 page 94)

HDMI control function (👉 page 105)

Sleep timer function (👉 page 106)

Quick select function (👉 page 107)

Web control function (👉 page 108)

Playback in ZONE2 (Separate room) (👉 page 110)



Basic operation

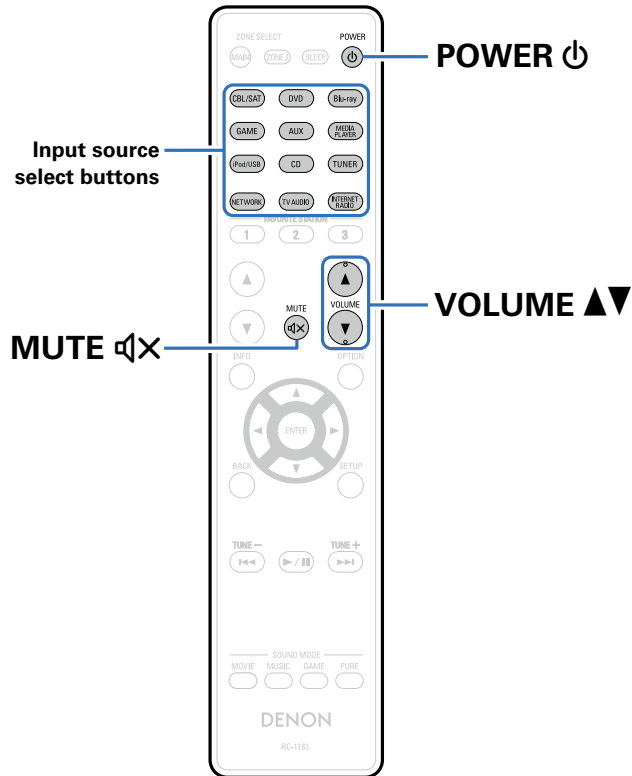

Turning the power on

1 Press **POWER** ⏻ to turn on power to the unit.



- You can also switch the power to standby by pressing ⏻ on the main unit.

Selecting the input source

1 Press the **input source select button** to be played back.
The desired input source can be selected directly.



- You can also select the input source by turning SOURCE SELECT knob on the main unit.





Adjusting the master volume

- 1 Use **VOLUME ▲▼** to adjust the volume.
 - The variable range differs according to the input signal and channel level setting.





- You can also adjust the master volume by turning MASTER VOLUME on the main unit.

Turning off the sound temporarily

- 1 Press **MUTE** .
 - “MUTE” indicator on the display flashes.
 -  appears on the TV screen.



- The sound is reduced to the level set at “Mute Level” ( page 127).
- To cancel, press MUTE  again. Muting can also be cancelled by adjusting the master volume.

Playing a DVD player/Blu-ray Disc player

The following describes the procedure for playing DVD player/Blu-ray Disc player.

- 1 **Prepare for playback.**
 - ① Turn on the power of the TV, subwoofer and player.
 - ② Change the TV input to the input of this unit.
- 2 **Press POWER**  to turn on power to the unit.
- 3 **Press DVD or Blu-ray to switch an input source for a player used for playback.**
- 4 **Play the DVD player or Blu-ray Disc player.**



Playing an iPod

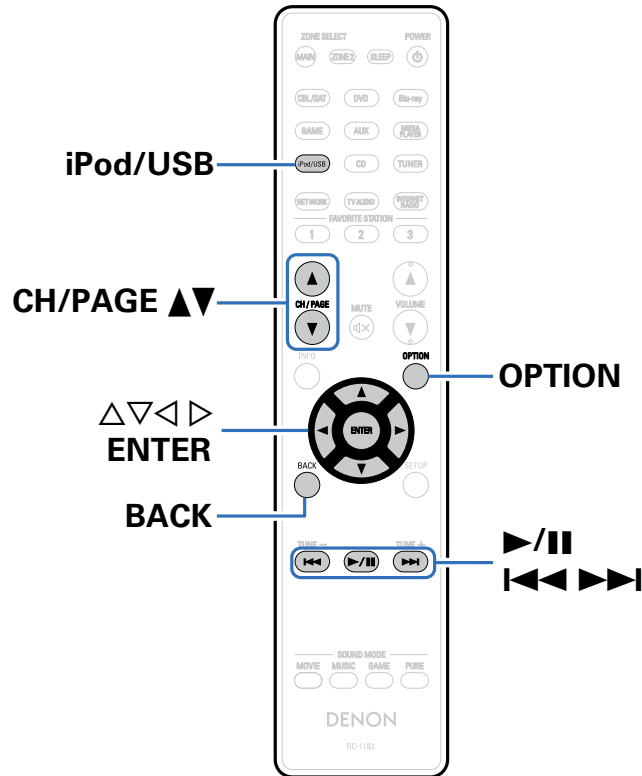

- You can use the USB cable provided with the iPod to connect the iPod with the unit's USB port and enjoy music stored on the iPod.
- For information on the iPod models that can be played back with this unit, see "Supported iPod/iPhone models" ([👉 page 37](#)).



Listening to music on an iPod

- 1 Connect the iPod to the USB port** ( [page 36](#)).
- 2 Press iPod/USB to switch the input source to “iPod/USB”.**

“Browse From iPod” is displayed on the display of this unit.

 - Nothing is displayed on the TV screen.
- 3 Operate iPod itself directly while seeing the iPod screen to play back music.**





- “iPod Browse Mode” has two modes, “From iPod” and “On-Screen”.
By default, “From iPod”, where you directly operate the iPod itself while looking at the iPod screen, is set.
- To change to “On-Screen”, where you perform operations while having the iPod information displayed on the TV screen, see “iPod Browse Mode settings” ( [page 46](#)).

NOTE

- Depending on the type of iPod and the software version, some functions may not operate.
- Note that Denon will accept no responsibility whatsoever for any problems arising with the data on an iPod when using this unit in conjunction with the iPod.

■ Playing the AirPlay ([page 83](#))

■ Operations available through the OPTION button

- iPod Browse Mode settings ( [page 46](#))
- Playing the same music in all zones (All Zone Stereo) ( [page 93](#))



iPod Browse Mode settings

In this mode, various lists and screens during playback on the iPod are displayed on the TV screen.

This section describes the steps up to playing back tracks on the iPod in "On-Screen".

1 Press OPTION when the input source is "iPod/USB".

The option menu screen is displayed.

2 Select "iPod Browse Mode", then press ENTER.

The "iPod Browse Mode" screen is displayed.

3 Use < > to select "On-Screen", then press ENTER.

- Operations available for "On-Screen" and "From iPod" are listed below.

iPod Browse Mode		From iPod	On-Screen
Playable files	Music file	✓	✓
	Video file	*	
Active buttons	Remote control unit (This unit)	✓	✓
	iPod	✓	

* Only the sound is played.

4 Use $\Delta \nabla \triangleright$ to select the file to be played, then press ENTER.

Playback starts.

Operation buttons

Function



Playback / Pause



Skip to previous track/Skip to next track

ENTER

(Press and hold)

Fast-reverse / Fast-forward

Playback / Pause

(Press and hold)

Stop



Skip to previous track/Skip to next track

(Press and hold)

Fast-reverse / Fast-forward

CH/PAGE $\blacktriangle \blacktriangledown$

Switch to previous page/switch to next page in the list display



- The display switches between track title, artist name, and album title etc. each time the main unit's STATUS is pressed during playback with "iPod Browse Mode" set to "On-Screen".
- English letters, numbers and certain symbols are displayed. Incompatible characters are displayed as "." (period).

Operations available through the OPTION button

- Performing repeat playback (page 47)
- Performing random playback (page 47)
- Playing the same music in all zones (All Zone Stereo) (page 93)



Performing repeat playback

- 1 Press **OPTION** with “iPod Browse Mode” set to “On-Screen”.

The option menu screen is displayed.

- 2 Use $\Delta \nabla$ to select “Repeat”, then press **ENTER**.

- 3 Use $\triangleleft \triangleright$ to select repeat playback mode.

Off (Default) : Repeat playback mode is canceled.

One : A file being played is played repeatedly.

All : All files in the folder currently being played are played repeatedly.

- 4 Press **ENTER**.

The display returns to the playback screen.

Performing random playback

- 1 Press **OPTION** with “iPod Browse Mode” set to “On-Screen”.

The option menu screen is displayed.

- 2 Use $\Delta \nabla$ to select “Random”, then press **ENTER**.

- 3 Use $\triangleleft \triangleright$ to select random playback mode.

Off (Default) : Disable random playback.

On : Randomly play back all tracks in the current playback folder.

- 4 Press **ENTER**.

The display returns to the playback screen.



- During random playback, each time playback of a track is completed, another track is randomly selected for playback from tracks in the folder. Therefore, it's possible that you may hear a track played back more than once during random playback.



Playing a USB memory device

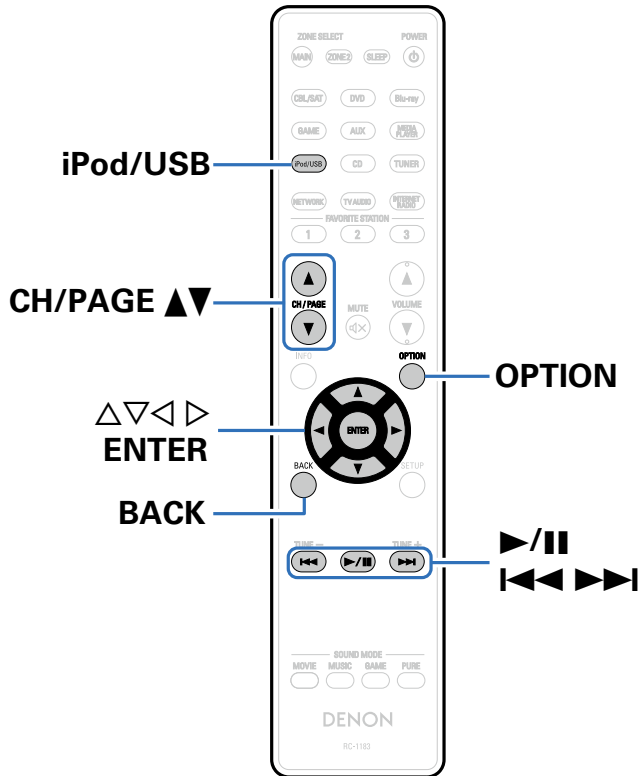

- Playing back music or viewing still picture (JPEG) files stored on a USB memory device.
- Only USB memory devices conforming to mass storage class and MTP (Media Transfer Protocol) standards can be played on this unit.
- This unit is compatible with USB memory devices in “FAT16” or “FAT32” format.
- This unit can play back the following files.
 - **WMA** (Windows Media Audio)
 - **MP3** (MPEG-1 Audio Layer-3)
 - **WAV**
 - **MPEG-4 AAC**
 - **FLAC** (Free Lossless Audio Codec)
 - **JPEG**
 - **ALAC** (Apple Lossless Audio Codec)



Playing files stored on USB memory devices

- 1 Connect the USB memory device to the USB port (🔗 page 36).
- 2 Press iPod/USB to switch the input source to “iPod/USB”.

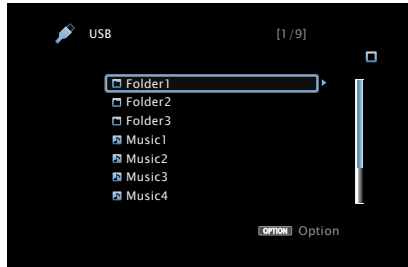

- 3 Use $\Delta \nabla \triangleright$ to select the file to be played, then press ENTER. Playback starts.

Operation buttons	Function
$\triangleright \parallel$	Playback / Pause
$\ll \triangleright \triangleright$	Skip to previous track/Skip to next track (Press and hold) Fast-reverse / Fast-forward*
ENTER	Playback / Pause (Press and hold) Stop
$\Delta \nabla$	Skip to previous track/Skip to next track (Press and hold) Fast-reverse / Fast-forward*
CH/PAGE $\blacktriangle \blacktriangledown$	Switch to previous page/switch to next page in the list display

* This function is available while an MP3 / WAV / AAC / FLAC file is being played back.









- When an MP3 music file includes album art data, the album art can be displayed while playing the file.
- This unit plays back picture (JPEG) files in the order in which they are stored in the folder.

NOTE

- Note that Denon will accept no responsibility whatsoever for any problems arising with the data on a USB memory device when using this unit in conjunction with the USB memory device.



■ Operations available through the OPTION button

- Performing repeat playback ( [page 87](#))
- Performing random playback ( [page 87](#))
- Searching content with keywords (Text Search) ( [page 89](#))
- Playing back music and a favorite picture at the same time (Slideshow) ( [page 90](#))
- Setting the Slideshow Interval ( [page 91](#))
- Adjusting the picture quality for your viewing environment (Picture Mode) ( [page 92](#))
- Playing the same music in all zones (All Zone Stereo) ( [page 93](#))



Listening to FM broadcasts

For antenna connections, see “Connecting an FM antenna” (📖 page 38).

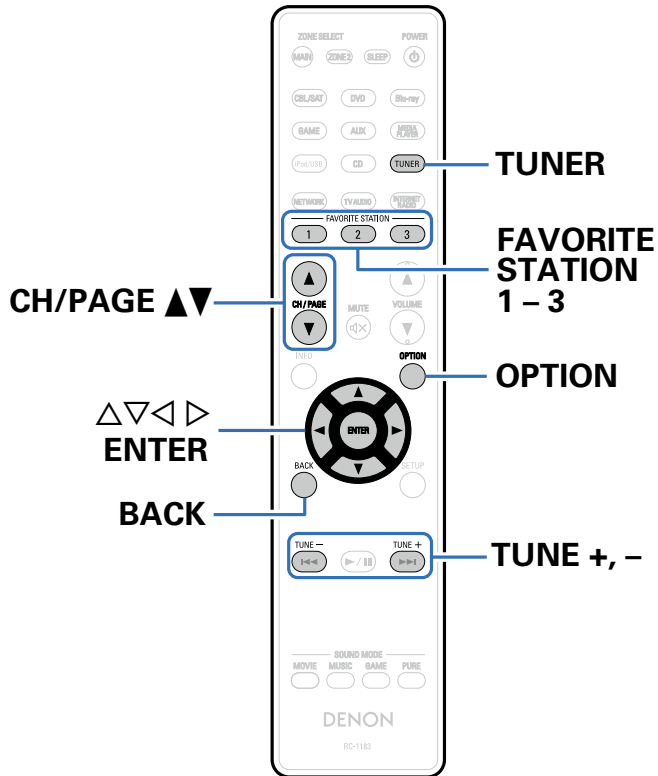

Listening to FM broadcasts

1 Press TUNER to switch the input source to “TUNER”.

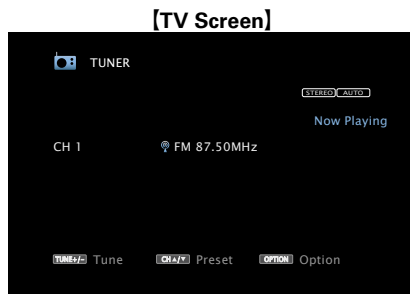

[Display of this unit]

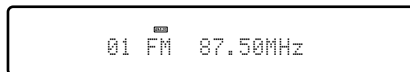

2 Press TUNE + or TUNE – to select the station you want to hear.

Scanning is performed until it finds an available radio station. When it finds a radio station, it stops the scan automatically and tunes in.













- The modes for receiving FM broadcasts consists of “Auto” mode that automatically searches available broadcast stations and “Manual” mode that lets you tune in using buttons to change the frequency. The default setting is “Auto”. You can also use “Direct Tune” to tune in by entering the frequency directly. In “Auto” mode, you cannot tune in to radio stations if the reception is not good. If this is the case, then use the “Manual” mode or “Direct Tune” to tune in.

Operation buttons	Function
TUNE +, –	Tuning (up/down)
CH/PAGE ▲▼	Preset channel selection
FAVORITE STATION 1 – 3	Call up FAVORITE STATION (Press and hold) Registering to FAVORITE STATION



■ Adding to the FAVORITE STATION button (page 81)

■ Operations available through the OPTION button

- Tuning in by entering the frequency (Direct Tune) ( page 53)
- RDS search ( page 54)
- PTY search ( page 54)
- TP search ( page 55)
- Radio Text ( page 56)
- Presetting the current broadcast station (Preset Memory) ( page 57)
- Changing the tuning mode (Tune Mode) ( page 56)
- Tuning in to stations and presetting them automatically (Auto Preset Memory) ( page 58)
- Specify a name for the preset broadcast station (Preset Name) ( page 58)
- Skipping preset broadcast stations (Preset Skip) ( page 59)
- Playing the same music in all zones (All Zone Stereo) ( page 93)

Tuning in by entering the frequency (Direct Tune)

You can enter the receiving frequency directly to tune in.

- 1 Press OPTION when the input source is "TUNER".**
The option menu screen is displayed.
- 2 Use Δ / ∇ to select "Direct Tune", then press ENTER.**
The screen that lets you enter the frequency is displayed.
- 3 Use Δ / ∇ to select a number and press \triangleright .**
 - If \triangleleft is pressed, the immediately preceding input is cancelled.
- 4 Repeat step 3 and enter the frequency of the radio station you want to hear.**
- 5 When setting is completed, press ENTER.**
The preset frequency is tuned in.



RDS search

RDS is a broadcasting service which allows a station to send additional information along with the regular radio program signal.

Use this function to automatically tune to FM stations that provide the RDS service.

Note that the RDS function only works when receiving RDS compatible stations.

- 1 Press OPTION when the input source is "TUNER".**
The option menu screen is displayed.
- 2 Use Δ / ∇ to select "RDS Search", then press ENTER.**
- 3 Press ENTER.**
The search for RDS stations begins automatically.



- If you use \triangleleft / \triangleright within 5 seconds after the broadcast station name is shown on the display, you can search for a different station.

PTY search

Use this function to find RDS stations broadcasting a designated program type (PTY).

PTY identifies the type of RDS program.

The program types and their displays are as follows:

NEWS	News	WEATHER	Weather
AFFAIRS	Current Affairs	FINANCE	Finance
INFO	Information	CHILDREN	Children's program
SPORT	Sports	SOCIAL	Social Affairs
EDUCATE	Education	RELIGION	Religion
DRAMA	Drama	PHONE IN	Phone In
CULTURE	Culture	TRAVEL	Travel
SCIENCE	Science	LEISURE	Leisure
VARIED	Varied	JAZZ	Jazz Music
POP M	Pop Music	COUNTRY	Country Music
ROCK M	Rock Music	NATION M	National Music
EASY M	Easy Listening Music	OLDIES	Oldies Music
LIGHT M	Light Classical	FOLK M	Folk Music
CLASSICS	Serious Classical	DOCUMENT	Documentary
OTHER M	Other Music		



- 1 Press OPTION when the input source is "TUNER".**
The option menu screen is displayed.
- 2 Use $\Delta \nabla$ to select "PTY Search", then press ENTER.**
- 3 Use $\Delta \nabla$ to call out the desired program type.**
- 4 Press ENTER.**
PTY search begins automatically.



- If you use $\triangleleft \triangleright$ within 5 seconds after the broadcast station name is shown on the display, you can search for a different station.

TP search

TP identifies programs that carry traffic announcements.

This allows you to easily find out the latest traffic conditions in your area before leaving home.

Use this function to find RDS stations broadcasting traffic programs (TP stations).

- 1 Press OPTION when the input source is "TUNER".**
The option menu screen is displayed.
- 2 Use $\Delta \nabla$ to select "TP Search", then press ENTER.**
- 3 Press ENTER.**
TP search begins automatically.



- If you use $\triangleleft \triangleright$ within 5 seconds after the broadcast station name is shown on the display, you can search for a different station.



Radio Text

RT allows RDS stations to send text messages that appear on the display. "Radio Text" appears on the display when radio text data is received.

- 1 Press OPTION when the input source is "TUNER".**
The option menu screen is displayed.
- 2 Use $\Delta \nabla$ to select "Radio Text", then press ENTER.**
- 3 Use $\triangleleft \triangleright$ to select "On", then press ENTER.**
 - While receiving an RDS broadcast station, the text data broadcast from the station is displayed.
 - If no text data is being broadcast, "NO TEXT DATA" is displayed.

Changing the tuning mode (Tune Mode)

You can change the mode for tuning into FM broadcasts. If you cannot tune in automatically with "Auto" mode, then change the mode to "Manual" and tune in manually.

- 1 Press OPTION when the input source is "TUNER".**
The option menu screen is displayed.
- 2 Use $\Delta \nabla$ to select "Tune Mode", then press ENTER.**
- 3 Use $\triangleleft \triangleright$ to select tuning mode, then press ENTER.**

Auto : Automatically search for and tune to a receivable radio station.

Manual : Manually change the frequency one step at a time each time the button is pressed.

Listening to preset stations

- 1 Use CH/PAGE $\blacktriangle \blacktriangledown$ to select the desired preset channel.**



- You can also select preset broadcast stations by pressing TUNER PRESET CH + or TUNER PRESET CH - on the main unit.



Presetting the current broadcast station (Preset Memory)

Your favorite broadcast stations can be preset so that you can tune them in easily. Up to 56 stations can be preset.

- 1 Tune in the broadcast station you want to preset** (👉 [page 52](#) “Listening to FM broadcasts”).
- 2 Press OPTION.**
The option menu screen is displayed.
- 3 Use Δ / ∇ to select “Preset Memory”, then press ENTER.**
The list of already preset channels is displayed.
- 4 Use Δ / ∇ to select the channel you want to preset, then press ENTER.**
The current broadcast station that is preset.
 - To preset other stations, repeat steps 1 to 4.

Channel	Default settings
1 – 8	87.50 / 89.10 / 98.10 / 108.00 / 90.10 / 90.10 / 90.10 / 90.10 / 90.10 MHz
9 – 16	90.10 / 90.10 / 90.10 / 90.10 / 90.10 / 90.10 / 90.10 / 90.10 / 90.10 MHz
17 – 24	90.10 / 90.10 / 90.10 / 90.10 / 90.10 / 90.10 / 90.10 / 90.10 / 90.10 MHz
25 – 32	90.10 / 90.10 / 90.10 / 90.10 / 90.10 / 90.10 / 90.10 / 90.10 / 90.10 MHz
33 – 40	90.10 / 90.10 / 90.10 / 90.10 / 90.10 / 90.10 / 90.10 / 90.10 / 90.10 MHz
41 – 48	90.10 / 90.10 / 90.10 / 90.10 / 90.10 / 90.10 / 90.10 / 90.10 / 90.10 MHz
49 – 56	90.10 / 90.10 / 90.10 / 90.10 / 90.10 / 90.10 / 90.10 / 90.10 / 90.10 MHz



Tuning in to stations and presetting them automatically (Auto Preset Memory)

A maximum of 56 radio stations can be automatically preset.

- 1 Press OPTION when the input source is "TUNER".**
The option menu screen is displayed.
- 2 Use $\Delta\nabla$ to select "Auto Preset Memory", then press ENTER.**
- 3 Press ENTER.**
The unit starts to tune in to radio stations automatically and preset them.
 - When presetting is completed, "Completed" is displayed for about 5 seconds and the option menu screen turns off.



- The preset memory is overwritten.

Specify a name for the preset broadcast station (Preset Name)

You can set the name to the preset broadcast station or change it. Up to eight characters can be input.

- 1 Press OPTION when the input source is "TUNER".**
The option menu screen is displayed.
- 2 Use $\Delta\nabla$ to select "Preset Name", then press ENTER.**
The Preset Name screen is displayed.
- 3 Use $\triangleleft\rangle$ to select the group of the broadcast station you want to name.**
- 4 Use $\Delta\nabla$ to select the broadcast station you want to name, then press ENTER.**
- 5 Use $\Delta\nabla$ to select a name label, then press ENTER.**
The screen that lets you edit the preset name is displayed.
 - If you select "Set Defaults", then the unit returns to displaying the frequency.
- 6 Enter the characters, then press "OK".**
 - For character input, see [page 121](#).



Skipping preset broadcast stations (Preset Skip)

When tuning preset broadcast stations, you can set groups or individual broadcast stations that you don't want to display in advance. The preset skip setting is useful when tuning in, because only your favorite stations are displayed.

- 1 Press OPTION when the input source is "TUNER".**
The option menu screen is displayed.
- 2 Use $\Delta \nabla$ to select "Preset Skip", then press ENTER.**
The Preset Skip screen is displayed.
- 3 To set the stations you want to skip by groups**
 - ① Use $\triangleleft \triangleright$ to select the group of broadcast stations you want to skip.**
 - ② Press Δ to select "Set No.* - * to Skip", then press ENTER.**
All broadcast stations in the group "* - *" you selected are not displayed.
(* are the selected group numbers)

- To set the stations you want to skip by stations**
 - ① Use $\triangleleft \triangleright$ to select the group of broadcast stations you want to skip.**
 - ② Use $\Delta \nabla$ to select the broadcast station you want to skip.**
 - ③ Use $\triangleleft \triangleright$ to select "Skip".**
The station you selected is not displayed.

Cancelling preset skip

- 1 While the Preset Skip screen is displayed, use $\triangleleft \triangleright$ to select a group containing a broadcast station to cancel the skip for.**
- 2 Use $\Delta \nabla$ to select a broadcast station to cancel the skip for.**
- 3 Use $\triangleleft \triangleright$ to select "On".**
The skip is cancelled.

NOTE

- Preset skip cannot be cancelled for groups.



Listening to Internet Radio

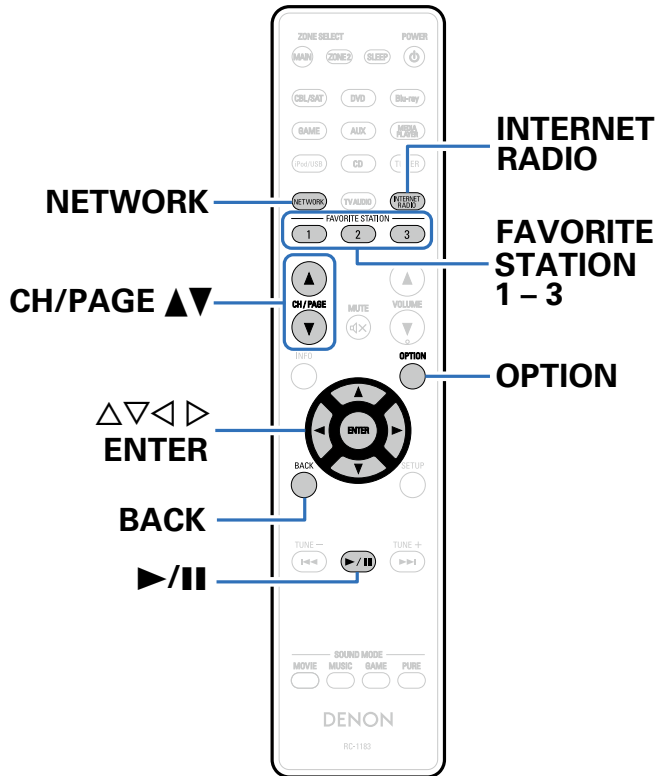

- Internet Radio refers to radio broadcasts distributed over the Internet. Internet Radio stations from around the world can be received.
- The broadcast station types and specifications supported by this unit for playback are as follows.
 - **WMA** (Windows Media Audio)
 - **MP3** (MPEG-1 Audio Layer-3)
 - **MPEG-4 AAC**



Listening to Internet Radio

- 1 Prepare for playback.**
 - Check the network environment, then turn on this unit's power (see page 39 "Connecting to a home network (LAN)").
- 2 Press NETWORK.**
 - You can also press INTERNET RADIO to select the input source "Internet Radio" directly.
- 3 Use $\Delta \nabla \triangleleft \triangleright$ to select "Internet Radio", then press ENTER.**

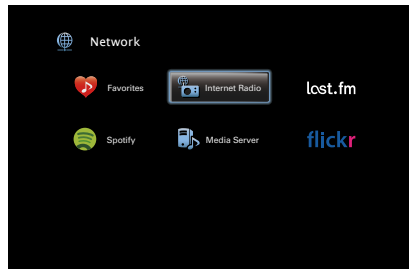

- 4 Use $\Delta \nabla$ to select the item you want to play, then press ENTER.**



***** (Country name) :

- Displays typical Internet Radio stations your country.

Search Stations :

- Displays all Internet Radio stations that this unit can tune in to.

Search Podcasts :

- Displays Internet Radio stations in the podcasts that this unit can tune in to.

Recommended Stations :

- Displays recommended Internet Radio stations.



radiodnon.com :

- Displays Internet Radio stations added to favorites in vTuner. For instructions on how to add to favorites in vTuner, see "Using vTuner to add Internet Radio stations to favorites" ( page 63).

Recently Played :



- Displays recently played Internet Radio stations. Up to 20 stations can be stored in "Recently Played".

Search by Keyword :

- Displays Internet Radio stations searched by keyword. For character input, see [page 121](#).

5 Use to select the station, then press ENTER.

Playback starts once buffering reaches "100%".

Operation buttons	Function
	Playback / Stop
ENTER	(Press and hold) Stop
CH/PAGE  	Switch to previous page/switch to next page in the list display
FAVORITE STATION 1 – 3	Call up FAVORITE STATION (Press and hold) Registering to FAVORITE STATION
INTERNET RADIO	Last played Internet Radio station



- The display switches between track title and radio station name etc. each time the main unit's STATUS is pressed.
- Any characters that cannot be displayed are replaced with "." (period).

NOTE

- The radio station database service may be suspended or be otherwise unavailable without notice.

Playing the last played Internet Radio station

1 Press INTERNET RADIO.

The source switches to "Internet Radio" and the last played radio station plays.



Using vTuner to add Internet Radio stations to favorites

There are many Internet Radio stations in the world, and this unit can tune into these stations. But finding the radio station you want to hear may be difficult, because there are too many stations. If this is the case, then please use vTuner, an Internet Radio station search website specifically designed for this unit. You can use your PC to search Internet Radio stations and add them as your favorites. This unit can play radio stations added to vTuner.

- 1 Check the MAC address of this unit (☞ page 156 "Information").**
 - The MAC address is necessary when you create an account for vTuner.
- 2 Use your PC to access the vTuner website (<http://www.radiodenon.com>).**
- 3 Enter the MAC address of this unit, then click "Go".**
- 4 Enter your E-mail address and a password of your choice.**

- 5 Select the search criteria (genre, region, language, etc.) of your choice.**
 - You can also enter a keyword to search for a station you want to hear.
- 6 Select the radio station of your choice from the list, and then click the Add to Favorites icon.**
- 7 Enter the name of the favorite group, then click "Go".**

A new favorite group that includes the selected radio station is created.

 - Internet Radio stations added to favorites in vTuner can be played from "radiodenon.com" (☞ page 62) with this unit.

■ Operations available through the OPTION button

- Registering to Favorites (☞ page 88)
- Searching content with keywords (Text Search) (☞ page 89)
- Playing back music and a favorite picture at the same time (Slideshow) (☞ page 90)
- Playing the same music in all zones (All Zone Stereo) (☞ page 93)



Playing back files stored on a PC and NAS

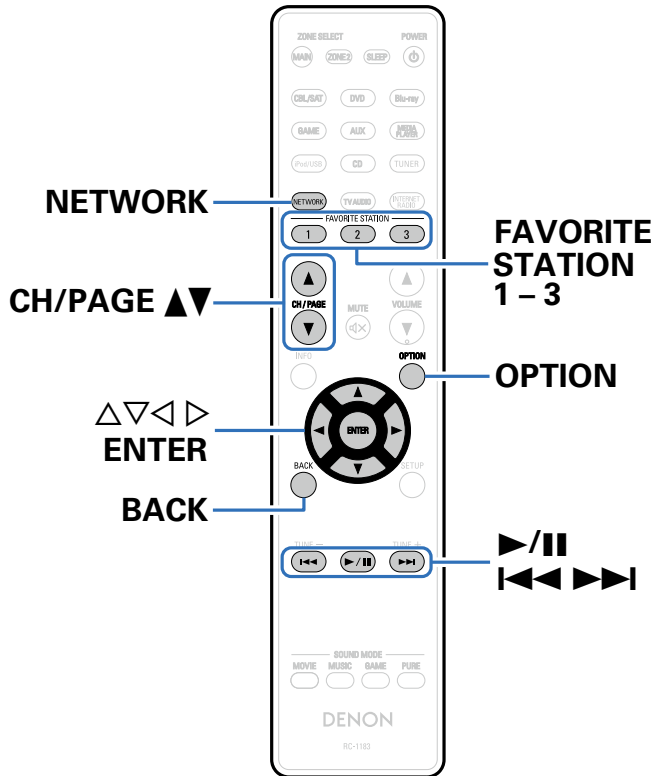

- This unit can play back music files and playlists (m3u, wpl) stored on a PC and on Network Attached Storage (NAS) that supports DLNA.
- The network audio playback function of this unit connects to the server using technologies shown below.
 - Windows Media Player Network Sharing Service
 - Windows Media DRM10
- This unit can play back the following files.
 - **WMA** (Windows Media Audio)
 - **MP3** (MPEG-1 Audio Layer-3)
 - **WAV**
 - **MPEG-4 AAC**
 - **FLAC** (Free Lossless Audio Codec)
 - **JPEG**
 - **ALAC** (Apple Lossless Audio Codec)



Applying media sharing settings

Here, we apply the settings to share music files stored on a PC and NAS on the network. If you are using a Media Server, be sure to apply this setting first.

■ When using Windows Media Player 12 (Windows 7 / Windows 8)

- 1 Start up Windows Media Player 12 on the PC.
- 2 Select "More streaming options..." in the "Stream".
- 3 Select "Allowed" in the drop-down list for "AVR-X2000".
- 4 Select "Allowed" in the drop-down list for "Media programs on this PC and remote connections...".
- 5 Click "OK" to finish.

■ When using Windows Media Player 11

- 1 Start up Windows Media Player 11 on the PC.
- 2 Select "Media Sharing" in the "Library".
- 3 Click the "Share my media" check box, select "AVR-X2000", and then click "Allow".
- 4 As you did in step 3, select the icon of the device (other PCs and mobile devices) you want to use as a media controller, and then click "Allow".
- 5 Click "OK" to finish.

■ Sharing media stored in NAS

Change settings on the NAS to allow this unit and other devices (PCs and mobile devices) used as media controllers to access the NAS. For details, see the owner's manual that came with the NAS.



Playing back files stored on a PC and NAS

Use this procedure to play music files, image files or playlists.

1 Prepare for playback.

- ① Check the network environment, then turn on this unit's power (☞ page 39 "Connecting to a home network (LAN)").
- ② Prepare the computer (☞ Computer's operating instructions).

2 Press NETWORK.

3 Use $\Delta \nabla \triangleleft \triangleright$ to select "Media Server", then press ENTER.

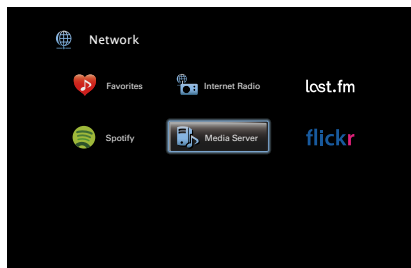

4 Use $\Delta \nabla$ to select the server including the file to be played, then press ENTER.

5 Use $\Delta \nabla \triangleright$ to select the file, then press ENTER. Playback starts once buffering reaches "100%".

Operation buttons	Function
$\blacktriangleright / \parallel$	Playback / Pause
$\blacktriangleleft \blacktriangleright$	Skip to previous track/Skip to next track (Press and hold) Fast-reverse / Fast-forward*
ENTER	Playback / Pause (Press and hold) Stop
$\Delta \nabla$	Skip to previous track/Skip to next track (Press and hold) Fast-reverse / Fast-forward*
CH/PAGE $\blacktriangle \blacktriangledown$	Switch to previous page/switch to next page in the list display
FAVORITE STATION 1 – 3	Call up FAVORITE STATION (Press and hold) Registering to FAVORITE STATION

* This function is available while an MP3 / WAV / AAC / FLAC file is being played back.













- The display switches between track title, artist name, and album title each time the main unit's STATUS is pressed.
- When a WMA (Windows Media Audio), MP3 or MPEG-4 AAC file includes album art data, the album art can be displayed while the music files are playing.
- If you use Ver.11 or later of Windows Media Player, the album art for WMA files can be displayed.
- WMA Lossless files can be played when using a server supporting transcoding, such as Windows Media Player Ver. 11 or later.
- This unit plays back picture (JPEG) files in the order in which they are stored in the folder.

NOTE

- When playing back music files with your PC or NAS connected through wireless LAN, audio may be interrupted depending on your wireless LAN environment. In this case, play back music files with your PC or NAS connected through wired LAN.
- Depending on the size of the still picture (JPEG) file, some time may be required for the file to be displayed.
- The order in which the tracks/files are displayed depends on the server specifications. If the tracks/files are not displayed in alphabetical order due to the server specifications, searching by the first letter may not work properly.

■ Operations available through the OPTION button

- Performing repeat playback ( page 87)
- Performing random playback ( page 87)
- Registering to Favorites ( page 88)
- Searching content with keywords (Text Search) ( page 89)
- Playing back music and a favorite picture at the same time (Slideshow) ( page 90)
- Setting the Slideshow Interval ( page 91)
- Displaying your desired video during audio playback (Video Select) ( page 91)
- Adjusting the picture quality for your viewing environment (Picture Mode) ( page 92)
- Playing the same music in all zones (All Zone Stereo) ( page 93)



Listening to Last.fm

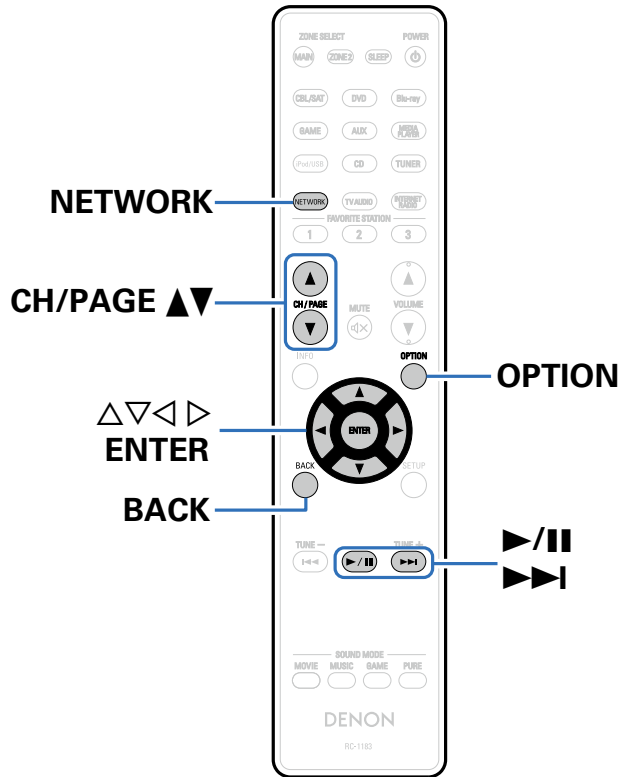

- Last.fm learns what you love... and it's a great way to discover new music.
Your new Denon AV receiver is very clever. You can create a free Last.fm profile when you start using your Denon AV receiver and magically keep track of all the songs you hear. When you sign in at <http://www.last.fm>, you can see your top music charts, view thousands of reviews, biographies and artwork, and get recommendations for local performances you won't want to miss. With an affordable subscription you can enjoy an endless choice of personalized ad-free radio stations. Check out <http://www.last.fm/subscribe> today for more details. Your subscription also gives you access to Last.fm radio on a great range of music products, including your Denon AV Receiver. This feature is not available in all countries. Visit <http://www.last.fm/hardware> to find out more.
- Last.fm radio is not available in all countries. Please check <http://www.last.fm/hardware> for more information. You'll also need a subscription. Get one today at <http://www.last.fm/subscribe>.



Listening to Last.fm

- 1 **Prepare for playback.**
 - Check the network environment, then turn on this unit's power (see page 39 "Connecting to a home network (LAN)").
- 2 **Press NETWORK.**
- 3 **Use $\Delta \nabla \leftarrow \rightarrow$ to select "Last.fm", then press ENTER.**

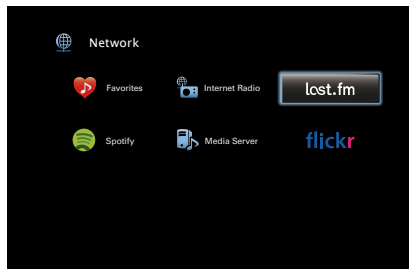

- 4 **If you have a Last.fm account, use $\Delta \nabla$ to select "I have a Last.fm account". Then press ENTER.**

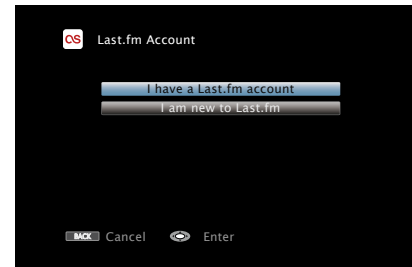

- If you do not have a Last.fm account, press ∇ to select "I am new to Last.fm". Then press ENTER. Create an account in accordance with the instructions on the screen.



5 Use Δ ∇ \triangleright to enter your username and password.

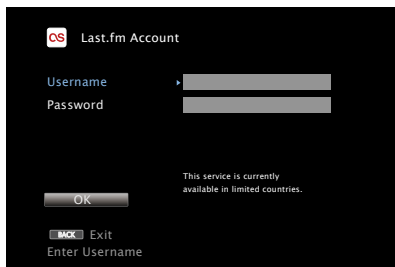

- For character input, see [page 121](#).
- The password should be no longer than 99 characters.
- Press BACK to cancel the input. When “Cancel Input?” is displayed, select “Yes”, then press ENTER.

6 After inputting the username and password, select “OK”, then press ENTER.

If the username and password match, the top menu for Last.fm is displayed.

7 Use Δ ∇ to select menu and then press ENTER.

Popular Stations :

- Play popular artists and tags in your area.

Your Recent Stations :

- Play your recent stations.

Your stations :

- You can play tracks from the following personalized stations (“Your Recommended Radio”, “Your Library”, “Your Friends’ Radio”, “Your Top Artists”.)

Search Stations :

- You can search station by Artist or Tag.

8 Use Δ ∇ to select a station, and press ENTER to start playback.

Playback starts and the following screen appears.

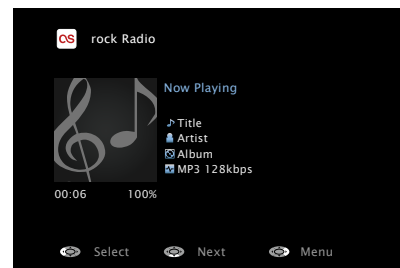

9 Press **▷** while a track is playing.

The Last.fm menu screen is displayed.

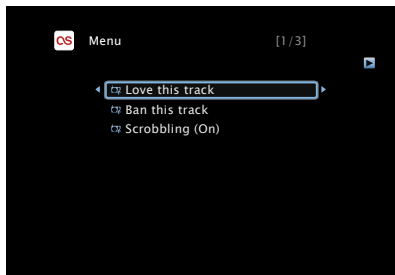

Love this track :

- Loving tracks improves your Last.fm recommendations, and you can optionally share them on popular social networks.

Ban this track :

- If you ban a track, we won't play it again. You can undo this on the Last.fm website.

Scrobbling :





- Scrobbling sends the tracks you played to your Last.fm account. You can see charts of the music you've been listening to, get recommendations for new music and events in your area and share your listening tastes with your friends. You can turn this service on or off using this option. The more you scrobble, the better your recommendations will become.

Operation buttons	Function
▷/ 	Playback
▷▷ 	Skip to next track
ENTER	(Press and hold) Stop
▽	Skip to next track
CH/PAGE ▲▼	Switch to previous page/switch to next page in the list display



- The display switches between track title and radio station name each time the main unit's STATUS is pressed.

■ Operations available through the OPTION button

- Performing repeat playback ( [page 87](#))
- Performing random playback ( [page 87](#))
- Displaying your desired video during audio playback (Video Select) ( [page 91](#))
- Adjusting the picture quality for your viewing environment (Picture Mode) ( [page 92](#))
- Playing the same music in all zones (All Zone Stereo) ( [page 93](#))



Log Out

Disassociate this unit from your Last.fm account.

- 1 Use \triangle / ∇ to select “Log Out”, then press ENTER.

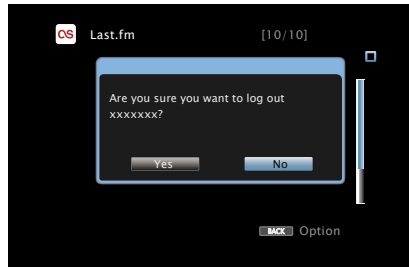

- 2 When the popup menu appears, use \triangleleft / \triangleright to select “Yes”, then press ENTER.



Viewing photographs on the Flickr site

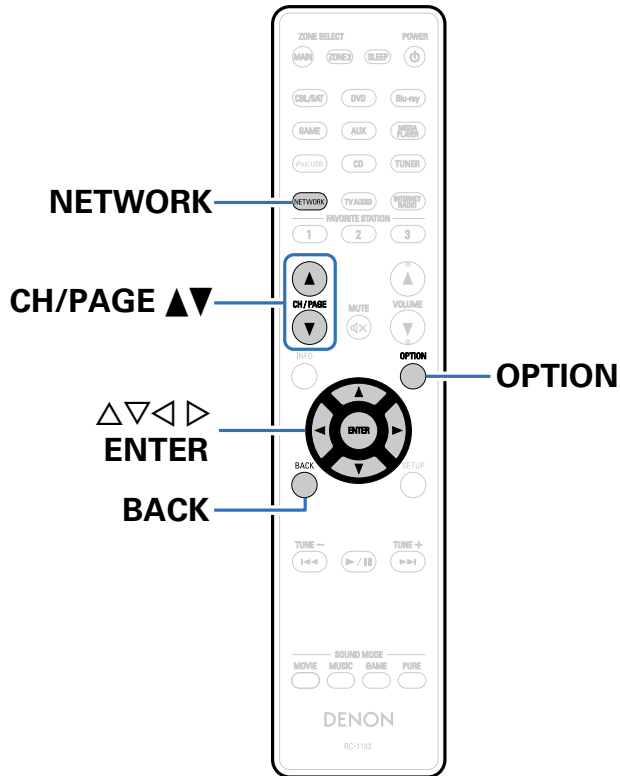

- Flickr is an online photograph sharing service that started in 2004. You can use this unit to view photographs that have been made public by Flickr users. You do not need an account to use Flickr. To view photographs that you recorded yourself, you need an account in order to upload these photographs to the Flickr server. For details, see the Flickr homepage.
<http://www.flickr.com/>
- You can view photographs shared by particular users, or all of the photographs shared on Flickr.



Viewing photographs shared by particular users

1 Prepare for playback.

- Check the network environment, then turn on this unit's power (☞ [page 39](#) "Connecting to a home network (LAN)").

2 Press NETWORK.

3 Use $\Delta \nabla \triangleleft \triangleright$ to select "Flickr", then press ENTER.

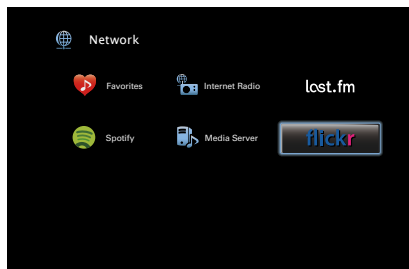

4 Use $\Delta \nabla$ to select "Add Flickr Contact", then press ENTER.

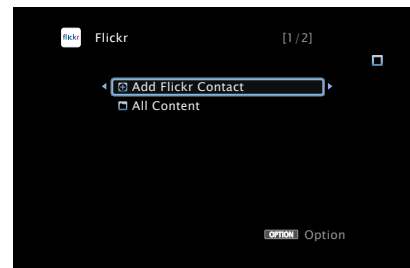

5 In "Contact", add the screen name (user name you want to view) you want to add.

- For character input, see [page 121](#).

6 After inputting the "Contact", press "OK".

The screen name is added to "Contact", and the screen name you entered in Step 5 is displayed on the top screen of Flickr.

- If you enter a screen name that does not exist, "The Flickr Contact you entered could not be found" is displayed. Check and enter the correct screen name.



7 Use $\Delta \nabla$ to select the screen name (user name you want to view) added to "Contact", then press ENTER.

8 Use $\Delta \nabla$ to select the folder, and then press ENTER.

Favorites :

- Displays the favorite photographs of the specified user.

Photostream :

- Displays a list of shared photographs.

PhotoSets :

- Displays the folder (photograph album) list.

Contacts :

- Displays the screen name used by the specified user in Contacts.

Remove this Contact :

- Deletes a user from Flickr Contact.

Add this Contact :

- Adds a user from Flickr Contact.

9 Use $\Delta \nabla \triangleright$ to select the photograph, and then press ENTER.

The selected photograph is displayed.

Operation buttons	Function
ENTER	Playback (Press and hold) Stop
$\Delta \nabla$	Display previous photograph/display next photograph
CH/PAGE $\blacktriangle \blacktriangledown$	Switch to previous page/switch to next page in the list display



Viewing all photographs on Flickr

- 1 Use Δ / ∇ to select "All Content", then press ENTER.

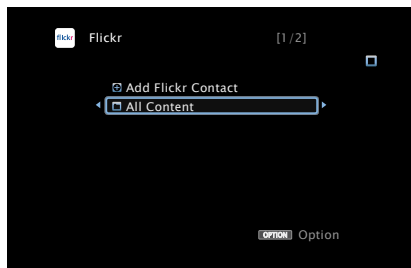

- 2 Use Δ / ∇ to select the folder, and then press ENTER.

Interestingness :

- Displays photographs that are popular from the number of user comments or number of times they are added as favorites.

Recent :

- Displays the most recently added photographs.

Search by text :

- Search for photographs by keyword.

- 3 Use Δ / ∇ to select the photograph, and then press ENTER.

The selected photograph is displayed.

NOTE

- Depending on the file format, some photographs may not be viewable.

Operations available through the OPTION button

- Setting the Slideshow Interval ([page 91](#))
- Displaying your desired video during audio playback (Video Select) ([page 91](#))
- Adjusting the picture quality for your viewing environment (Picture Mode) ([page 92](#))
- Playing the same music in all zones (All Zone Stereo) ([page 93](#))



Listening to Spotify

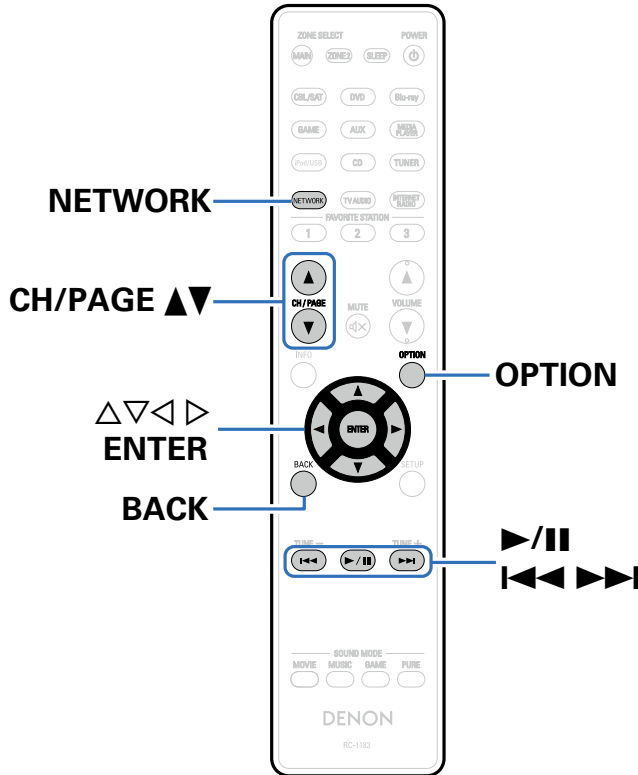

Introduce your Denon to a whole new world of music. With Spotify, you can enjoy instant access to millions of songs. A Spotify Premium subscription is required. For details, see the Spotify homepage. <http://www.spotify.com>

Listening to Spotify

1 Prepare for playback.

- ① Check the network environment, then turn on this unit's power (refer to page 39 "Connecting to a home network (LAN)").
- ② Complete step 5 and obtain a Spotify account.
 - If you already have a Spotify account, you do not need to obtain a new account. Use your existing Spotify account.

2 Press NETWORK.

3 Use ▲▼◀▶ to select "Spotify", then press ENTER.

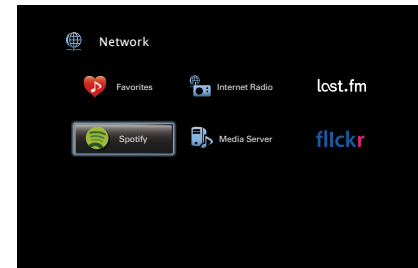

4 If you have a Spotify account, then press ENTER.

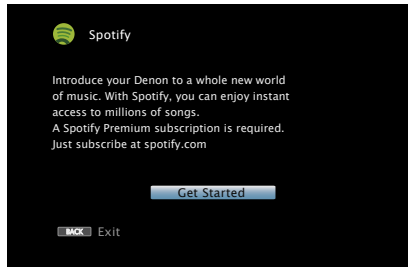

5 Use Δ ∇ \triangleright to enter your username and password.

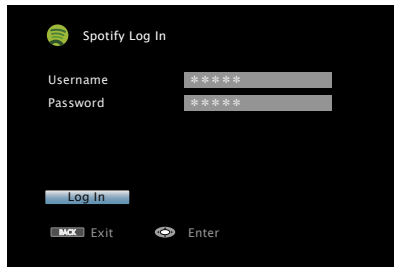

- For character input, see [page 121](#).
The types of characters that can be input are as shown below.

[Upper case characters/Numbers/Symbols]
 ABCDEFGHIJKLMNOPQRSTUVWXYZ
 ÄÅÁÂÃÄÅÆÇÐÈÉÊËÌÍÎÏÑÒÓÔÕÖØÙÚÛÜÝÞ
 0123456789
 ! " # \$ % & ' () * + , ; < = >

[Lower case characters/Numbers/Symbols]
 abcdefghijklmnopqrstuvwxyz
 äåáâãäåæçðèéêëìíîïñòóôõöøùúûüýþß
 0123456789
 . @ - _ / : ~ ? [\] ^ ' { | }

- The password should be no longer than 99 characters.
- Press BACK to cancel the input. When “Cancel Input?” is displayed, select “Yes”, then press ENTER.

6 After inputting the username and password, select “Log In”, then press ENTER.

If the username and password match, the top menu for Spotify is displayed.



7 Use $\Delta\nabla$ to select menu and then press ENTER.

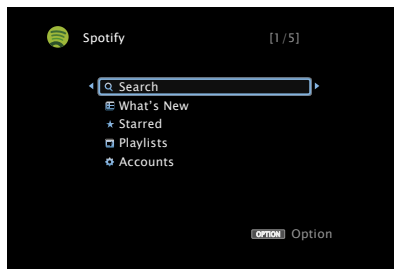

Search :

- Searches for tracks, artists and albums by entering keywords.

What's New :

- Displays the list of the latest albums.

Starred :

- Displays the list of the starred tracks.

Playlists :

- Displays the playlists for Spotify.

Accounts :

- Manages accounts (Log out, Add new user, Switch to user).

8 Use $\Delta\nabla$ to select a station, and press ENTER to start playback.

Playback starts and the following screen appears.

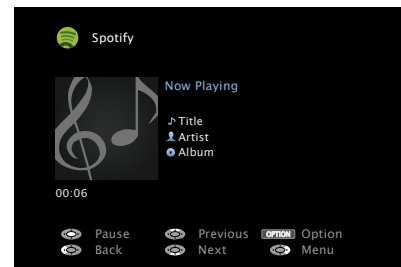

Operation buttons	Function
$\blacktriangleright/\parallel$	Playback / Pause
$\blacktriangleleft\blacktriangleleft\blacktriangleright\blacktriangleright$	Skip to previous track/Skip to next track (Press and hold) Fast-reverse / Fast-forward
ENTER	Playback / Pause (Press and hold) Stop
$\Delta\nabla$	Skip to previous track/Skip to next track (Press and hold) Fast-reverse / Fast-forward
CH/PAGE $\blacktriangle\blacktriangledown$	Switch to previous page/switch to next page in the list display



9 Press **▷** while a track is playing.

The Spotify menu screen is displayed.

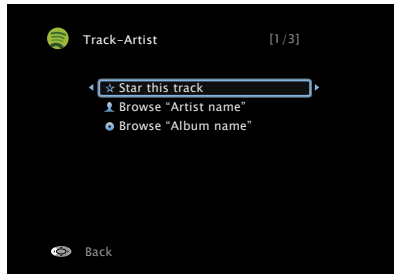

Star this track :

- Adds a star to the selected track.

Browse “Artist name” :

- Displays the list of albums by the artist of the track that is being played back.

Browse “Album name” :

- Displays the list of tracks on the album that is being played back.



- The display switches between track title, artist name, and album title each time the main unit’s STATUS is pressed.

■ Operations available through the OPTION button

- Performing repeat playback (🔍 page 87)
- Performing random playback (🔍 page 87)
- Displaying your desired video during audio playback (Video Select) (🔍 page 91)
- Adjusting the picture quality for your viewing environment (Picture Mode) (🔍 page 92)
- Playing the same music in all zones (All Zone Stereo) (🔍 page 93)



Adding to the FAVORITE STATION button

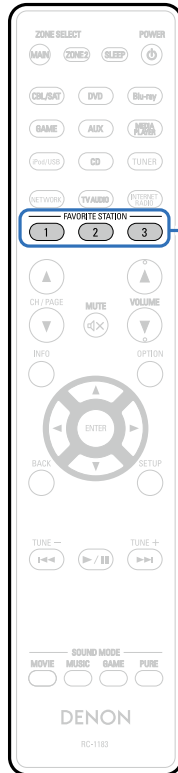

FAVORITE STATION 1 – 3

With a single press of these, you can call up registered radio stations and contents

You can add up to three types of content.

1 Press and hold one of the FAVORITE STATION 1 – 3 buttons for 3 seconds or longer while playing back a content or listening to a radio station.

The content you are playing back or the radio station you are listening to is registered to the pressed button.

- Contents that can be added to the FAVORITE STATION button differ depending on the input source.

Input source	Contents that can be added
TUNER	Radio station
Internet Radio	Top list of content / Internet Radio station
Media Server	Top list of content / Track of Media Server
Last.fm	Top list of content
Flickr	Top list of content
Spotify	Top list of content
Favorites	Top list of content / Internet Radio station / Track of Media Server



Playing back content added to the FAVORITE STATION button

You can easily call up content by pressing the FAVORITE STATION button.

1 Press one of the FAVORITE STATION 1 – 3 buttons that you added content to.

Playback starts.



- Internet Radio stations are already registered to the FAVORITE STATION 1 – 3 buttons. However, you may not be able to play the stations due to restrictions imposed by the radio stations.

NOTE

- The following operations update the database on the Media Server, which may make the added music files unplayable.
 - When you quit the Media Server and then restart it.
 - When music files are deleted or added on the Media Server.



AirPlay function

Music files stored on your iPhone, iPod touch, iPad or iTunes can be played on this unit via the network.

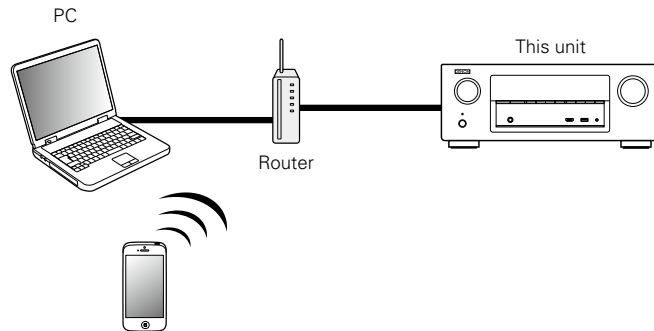

Playing songs from your iPhone, iPod touch or iPad

If you update your “iPhone/iPod touch/iPad” to iOS 4.2.1 or later, you can stream music stored in your “iPhone/iPod touch/iPad” directly to this unit.

- 1 Connect your iPhone, iPod touch or iPad Wi-Fi to the same network as this unit.**
 - For details, see your device’s manual.
- 2 Play the song on your iPhone, iPod touch or iPad.**
 - ▶ is displayed on the iPhone, iPod touch or iPad screen.
- 3 Tap the AirPlay icon ▶.**
- 4 Select the speaker you want to use.**

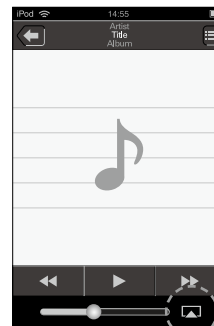

Playing iTunes music with this unit

- 1 Install iTunes 10, or later, on a Mac or Windows PC that is connected to the same network as this unit.**
- 2 Turn this unit ON.**
Set "IP Control" (🔗 page 156) to "Always On" for this unit.
- 3 Launch iTunes and click the AirPlay icon  displayed the window and select this unit from the list.**

NOTE

- When "IP Control" is set to "Always On", the unit consumes more standby power.



- 4 Choose a song and click play in iTunes.**
The music will stream to this unit.

Selecting multiple speakers (devices)

It is possible to play iTunes songs on your home's AirPlay compatible speakers (devices) other than those of this unit.

- 1 Click the AirPlay icon  and select "Multiple".**
- 2 Check the speakers you want to use.**

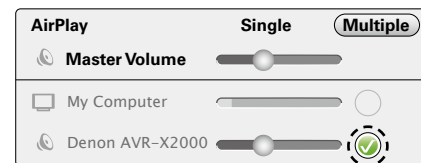

NOTE

- In playback using the AirPlay function, the sound is output at the iPhone, iPod touch, iPad or iTunes volume setting level. You should turn down the iPhone, iPod touch, iPad or iTunes volume prior to playback and then adjust it to a suitable level.



Perform iTunes playback operations with the remote control unit of this unit

With this unit's remote control unit, you can perform iTunes song play, pause, and auto search (cue) operations.

- 1 Select "Edit" – "Preferences..." on the menu.
- 2 Select "Devices" in the iTunes setting window.
- 3 Check "Allow iTunes audio control from remote speakers", and then click "OK".



-  is displayed on the menu screen while AirPlay is being operated.
- Source input will be switched to "NETWORK" when AirPlay playback is started.
- You can stop AirPlay playback by pressing the < or choosing other input source.
- To see song and artist names together, press STATUS on the main unit.
- For information about how to use iTunes, also see the Help for iTunes.
- The screen may differ depending on the OS and software versions.

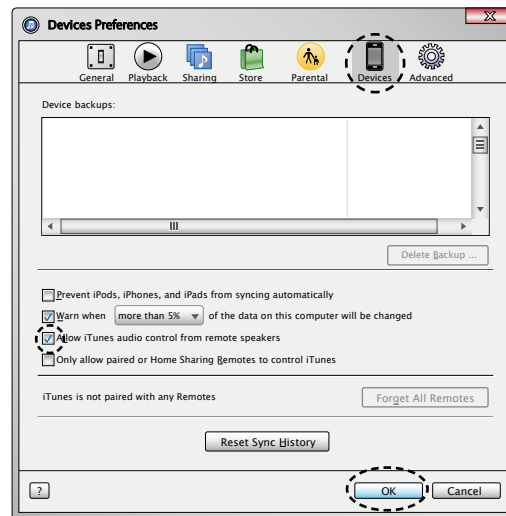

Convenience functions

This section explains how to use convenient functions that can be used for each input source.

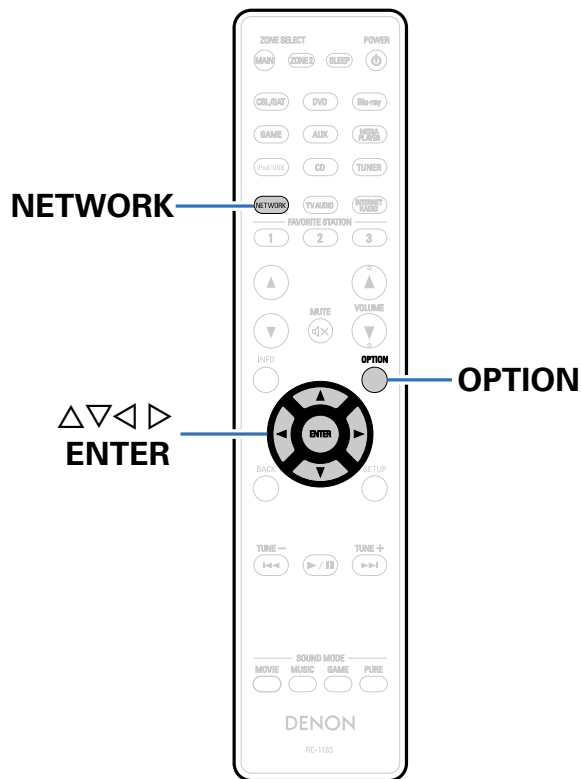

Performing repeat playback

□ Supported input sources : USB / Media Server / Spotify

- 1 While content is playing, press OPTION.**
The option menu screen is displayed.
- 2 Use $\Delta \nabla$ to select "Repeat", then press ENTER.**
- 3 Use $\triangleleft \triangleright$ to select repeat playback mode.**

Off (Default) : Repeat playback mode is canceled.

One : A file being played is played repeatedly.

All : All files in the folder currently being played are played repeatedly.

- 4 Press ENTER.**
The display returns to the playback screen.

Performing random playback

□ Supported input sources : USB / Media Server / Spotify

- 1 While content is playing, press OPTION.**
The option menu screen is displayed.
 - 2 Use $\Delta \nabla$ to select "Random", then press ENTER.**
 - 3 Use $\triangleleft \triangleright$ to select random playback mode.**

Off (Default) : Disable random playback.

On : Randomly play back all tracks in the current playback folder.

 - 4 Press ENTER.**
The display returns to the playback screen.
-  During random playback, each time playback of a track is completed, another track is randomly selected for playback from tracks in the folder. Therefore, it's possible that you may hear a track played back more than once during random playback.



Registering to Favorites

You can add up to 100 items as favorites for Internet Radio and Media Server.

❑ **Supported input sources : Internet Radio / Media Server**

1 While content is playing, press OPTION.

The option menu screen is displayed.

2 Use $\Delta \nabla$ to select “Save to Favorites”, then press ENTER.

“Favorite added” is displayed, and the current content is added to favorites.

- The display returns to the playback screen when the procedure is completed.

Playing back content added in “Save to Favorites”

1 Press NETWORK.

2 Use $\Delta \nabla \triangleleft \triangleright$ to select “Favorites”, then press ENTER.

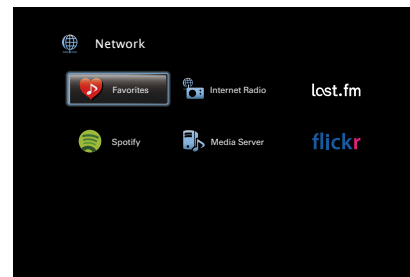

3 Use $\Delta \nabla$ to select the content you want to play, and then press ENTER.

Playback starts.



Deleting content added to favorites

- 1** Press **NETWORK**.
- 2** Use $\Delta \nabla \triangleleft \triangleright$ to select **"Favorites"**, then press **ENTER**.
- 3** Use $\Delta \nabla$ to select the content you want to delete from favorites, then press **OPTION**.
The option menu screen is displayed.
- 4** Use $\Delta \nabla$ to select **"Remove from Favorites"**, then press **ENTER**.
"Favorite removed" is displayed, and the selected content is deleted from favorites.
 - The display returns to the original screen when the procedure is completed.

Searching content with keywords (Text Search)

- Supported input sources : USB / Internet Radio / Media Server

- 1** While content is playing, press **OPTION**.
The option menu screen is displayed.
- 2** Use $\Delta \nabla$ to select **"Text Search"**, then press **ENTER**.
The keyboard input screen is displayed.
- 3** Enter the first character of the Internet Radio station or file you want to search for, and then press **"OK"**.
 - For character input, see [page 121](#).
- 4** Use $\Delta \nabla$ to select the content you want to play, and then press **ENTER**.
Playback starts.



- "Text Search" searches for Internet Radio stations or files that start with the entered first character from the displayed list.

NOTE

- "Text Search" may not work for some lists.



Playing back music and a favorite picture at the same time (Slideshow)

❑ Supported input sources : USB

1 Play back a still picture.

- Playing back still pictures stored on USB memory devices ( page 49).

2 Play back a music file (page 49).

3 Press OPTION.



The option menu screen is displayed.

4 Use Δ / ∇ to select “Slideshow”, then press ENTER.

The option menu disappears, and the picture you were viewing is shown on the screen.

❑ Supported input sources : Internet Radio / Media Server

1 Play back a still picture.

- Playing back still pictures stored on Media Server ( page 64).
- Playing back still pictures stored on Flickr ( page 73).

2 Play back a music file of Media Server or Internet Radio station (page 61, 66).

3 Press OPTION.

The option menu screen is displayed.

4 Use Δ / ∇ to select “Slideshow”, then press ENTER.

The option menu disappears, and the picture you were viewing is shown on the screen.



Setting the Slideshow Interval

Set the playback interval when playing back a slideshow of still image (JPEG) files stored on a USB memory stick or media server, or on the Flickr website.

❑ **Supported input sources : USB / Media Server / Flickr**

- 1 While the list is displayed, press OPTION.**
The option menu screen is displayed.
- 2 Use $\Delta \nabla$ to select "Slideshow Interval", then press ENTER.**
- 3 Use $\triangleleft \triangleright$ to set the display time.**

Off : The slide show is not played back.

5s (Default) – 60s : Set the time for displaying a single picture when playing back images in the slide show.

- 4 Press ENTER.**

Displaying your desired video during audio playback (Video Select)

This unit can display video from a different source on TV during audio playback.

You can set this for each input source.

❑ **Supported input sources : iPod/USB / CD* / TUNER / NETWORK**
 * Available when none of HDMI, component video or video connector is assigned.

- 1 Press OPTION during audio playback.**
The option menu screen is displayed.
- 2 Use $\Delta \nabla$ to select "Video Select", then press ENTER.**
- 3 Use $\triangleleft \triangleright$ to select the Video Select mode.**

Off (Default) : Disable Video Select mode.

On : Enable Video Select mode.

- 4 If you selected "On" in step 3, press ∇ and select "Source".**
- 5 Use $\triangleleft \triangleright$ to select the input source for video you want to play back, and press ENTER.**



Adjusting the picture quality for your viewing environment (Picture Mode)

- ❑ **Supported input sources : CBL/SAT / DVD / Blu-ray / GAME/ AUX / MEDIA PLAYER / iPod/USB / NETWORK / CD* / TV AUDIO***

* You can set the picture mode when an HDMI, component video or video connector is assigned.

- 1 Press OPTION during video playback.**
The option menu screen is displayed.
- 2 Use Δ / ∇ to select "Picture Mode", then press ENTER.**

- 3 Use \triangleleft / \triangleright to select picture mode.**

Off : No picture quality adjustment is done with this unit.

Standard : The standard mode suited for most living room viewing environments.

Movie : A mode suited for watching movies in a dark room such as a theater room.

Vivid : A mode that makes graphic images for games, etc. brighter and more vivid.

Streaming : A mode suited for low bit rate video sources.

Custom : Adjusts the picture quality manually.

- 4 Press ENTER.**



Playing the same music in all zones (All Zone Stereo)

You can play back music in another room (ZONE2) simultaneously that is played back in MAIN ZONE.

It is useful when you want to enjoy the same music at the same time in multiple rooms during home party or when you want to play back the same BGM in the entire house.

- 1 Turn on the power for the multi-zones (ZONE2) that you want to playback using All Zone Stereo mode in advance.**
- 2 Press MAIN to switch the zone mode.**
MAIN lights.
- 3 Press OPTION.**
The option menu screen is displayed.
- 4 Use $\Delta \nabla$ to select "All Zone Stereo", then press ENTER.**
- 5 Use $\triangleleft \triangleright$ to select "On", then press ENTER.**
The input source for the multi-zones (ZONE2) is switched to the same as the one for MAIN ZONE, and playback in the All Zone Stereo mode starts.

■ Stopping the All Zone Stereo mode

- 1 During playback in All Zone Stereo mode, press OPTION.**
The option menu screen is displayed.
- 2 Use $\Delta \nabla$ to select "All Zone Stereo", then press ENTER.**
- 3 Use $\triangleleft \triangleright$ to select "Off", then press ENTER.**



- The All Zone Stereo mode is also stopped when you:
 - Turn MAIN ZONE off.
 - Change the input source for MAIN ZONE.
 - Change the sound mode.
- When "HDMI Audio Out" ( [page 132](#)) is set to "TV", the All Zone Stereo mode is not available.



Selecting a sound mode

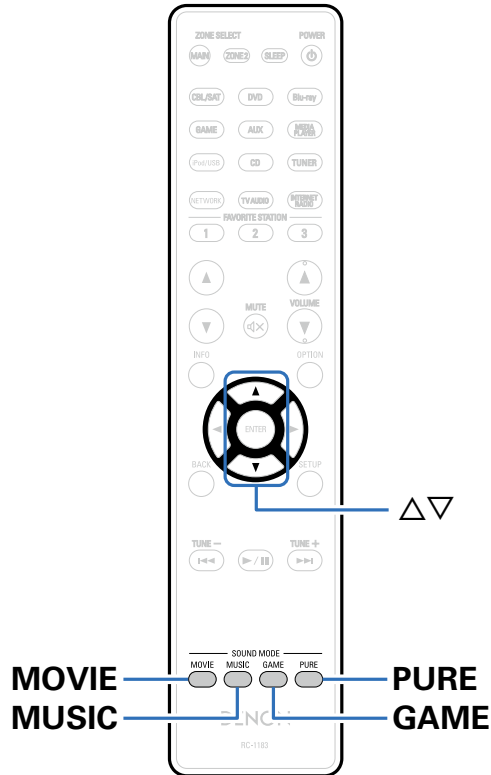

This unit allows you to enjoy various kinds of surround and stereo playback modes.

Multi-channel audio formats are provided on popular movie and music disc formats such as Blu-ray and DVD, as well as being supported by digital broadcasting, and even by streaming movies and music from internet-based subscription services.

This unit supports playback of almost all of these multi-channel audio formats. It also supports surround playback of audio formats other than multi-channel audio such as 2-channel stereo audio.



- For audio formats recorded on a disc, see the disc jacket or label.



Selecting a sound mode

1 Press MOVIE, MUSIC or GAME to select a sound mode.

MOVIE : Switches to the sound mode suitable for enjoying movies and TV programs.

MUSIC : Switches to the sound mode suitable for enjoying music.

GAME : Switches to the sound mode suitable for enjoying games.



- The MOVIE, MUSIC, or GAME button memorizes the last sound mode selected for its button. Pressing MOVIE, MUSIC, or GAME recalls the same sound mode as the one selected at the previous playback.
- If the content played back does not support the previously selected sound mode, the most appropriate sound mode for the content is automatically selected.

■ Switching the sound mode

- Press and hold MOVIE, MUSIC or GAME displays a list of the sound modes that can be selected. Each time you press MOVIE, MUSIC or GAME, the sound mode changes.
- While the list is displayed, you can also use Δ / ∇ to select a sound mode.
- Try out various sound modes and enjoy sound mode in your favorite mode.

[Example] When MOVIE is pressed and held

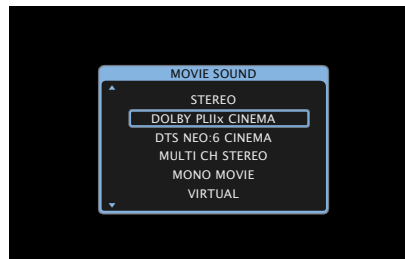

This unit provides not only sound modes that conform to the formats recorded on discs such as Dolby and DTS but also extended types of modes that match your speaker configuration including front height speakers and surround back speakers and “original sound modes” that create atmosphere of ROCK ARENA and JAZZ CLUB, etc.



Direct playback

Sound recorded in source is played as is.

- 1 **Press PURE to select “DIRECT”.**
Direct playback begins.

Pure Direct playback

This mode is for playback with higher sound quality than in “DIRECT” mode, by turning off the front panel display panel, which can eliminate faint low level noise from creeping into sensitive analog circuitry.

- 1 **Press PURE to select “PURE DIRECT”.**
The display goes dark, and Pure Direct playback begins.



- In DIRECT and PURE DIRECT sound modes, the following items cannot be adjusted.
 - Tone (🔧 page 126)
 - Restorer (🔧 page 128)
 - MultEQ® XT (🔧 page 128)
 - Dynamic EQ (🔧 page 128)
 - Dynamic Volume (🔧 page 129)

NOTE

- Video signals are only output when HDMI signals are played in the PURE DIRECT mode.
- When the PURE DIRECT mode has been selected, the display turns off after about 5 seconds.



■ Description of sound mode types

Dolby sound mode

Sound mode type	Description
DOLBY PLIIx*1	This mode can be selected when the Dolby Pro Logic IIx decoder is used to play back 2-channel sources in 6.1/7.1-channel surround sound including the surround back channel(s). By adding the surround back channel(s), a more enveloping surround environment is produced, compared to Dolby Pro Logic II. There are three playback modes: "Cinema" mode that is optimized for movie playback, "Music" mode that is optimized for music playback, and "Game" mode that is optimized for game play.
DOLBY PLII	This mode can be selected when the Dolby Pro Logic II decoder is used to play back 2-channel sources in 5.1-channel surround sound with an enveloping surround sound experience.
DOLBY PLIIz*2	This mode can be selected when the Dolby Pro Logic IIz decoder is used to play back 2-channel sources in 7.1-channel surround sound with added front height channels. By adding front height channels, the front soundstage becomes dramatically taller, simulating the effect of listening in a large movie theater or concert hall.
DOLBY DIGITAL	This mode can be selected when playing sources recorded with Dolby Digital.
DOLBY DIGITAL EX*1	Using the Dolby Digital EX decoder, this mode plays Dolby Digital sources in 6.1/7.1-channel surround sound with added surround back channel(s). By adding surround back speaker(s), sounds can be heard coming at you from behind and not just from the sides.
DOLBY TrueHD	This mode can be selected when playing sources recorded in Dolby TrueHD.
DOLBY DIGITAL Plus	This mode can be selected when playing sources recorded with Dolby Digital Plus.

*1 This can be selected when "Speaker Config." – "Surr. Back" ( [page 152](#)) is not set to "None".

*2 This can be selected when "Speaker Config." – "Front Height" ( [page 152](#)) is not set to "None".



DTS sound mode

Sound mode type	Description
DTS NEO:6	This mode can be selected when a DTS NEO:6 decoder is used to play back 2-channel source in 6.1/7.1-channel surround sound including the surround back channel. There is a "Cinema" mode optimized for movie playback, and a "Music" mode optimized for music playback.
DTS SURROUND	This mode can be selected when playing sources recorded in DTS.
DTS ES DSCRT6.1*1	This mode is suitable for playing discs recorded in DTS-ES. The surround back channel added using the discrete method is played as an independent channel. Since all channels are independent, the 360-degree spacial expressiveness and sound localization are enhanced.
DTS ES MTRX6.1*2	This mode is suitable for playing discs recorded in DTS-ES. The surround back channel added to the surround-left and surround-right channels by a matrix encoder at software recording time is decoded by this unit's matrix decoder and played from each channel (surround left, surround right, surround back).
DTS 96/24	This mode can be selected when playing sources recorded in DTS 96/24.
DTS-HD	This mode can be selected when playing sources recorded in DTS-HD.
DTS Express	This mode can be selected when playing sources recorded in DTS Express.

*1 This mode can be selected when only one surround back speaker is used and no front height speaker is used.

*2 This can be selected when "Speaker Config." – "Surr. Back" ( page 152) is not set to "None".

PCM multi-channel sound mode

Sound mode type	Description
MULTI CH IN	This mode can be selected when playing multi-channel PCM sources.



Original sound mode

Sound mode type	Description
MULTI CH STEREO	This mode is for enjoying stereo sound from all speakers. Stereo audio (2-channel) sources are played back via the front (L/R) speakers, the surround speakers and if connected the surround back speakers.
ROCK ARENA	This mode simulates the expansive sound of a live concert in an arena.
JAZZ CLUB	This mode puts you right in the middle of an intimate jazz club.
MONO MOVIE	This mode works with monaural audio sources and delivers a surround sound effect. For optimum channel balance and surround sound effects, connect the monaural source to both of the front (L/R) audio inputs.
VIDEO GAME	This mode provides an exciting, dynamic surround sound effect with your favorite action video games.
MATRIX	This mode adds a spacious surround sound effect with stereo music sources.
VIRTUAL	This mode lets you experience an expansive surround sound effect when playing back through just the front (L/R) speakers only, and when listening with stereo headphones.



Stereo sound mode

Sound mode type	Description
STEREO	<p>This mode plays 2-channel stereo audio with no additional surround sound processing.</p> <ul style="list-style-type: none"> • Sound is output from the front left and right speakers, and subwoofer if connected. • When multi-channel signals are inputted, they are mixed down to 2-channel audio and are played back with no additional surround sound processing.

Direct sound mode

Sound mode type	Description
DIRECT	<p>This mode provides a direct input-to-output path with minimal audio processing, bypassing any unnecessary stages for purest sound.</p>
PURE DIRECT	<p>This mode provides the direct audio signal path benefit of the Direct mode along with disabling additional stages that might possibly have an affect on sound quality.</p> <p>In Pure Direct mode, the following elements are turned off:</p> <ul style="list-style-type: none"> • The front panel display and its driver circuitry are shut down. The display will temporarily come on when adjusting the volume, etc., but will turn off again once the adjustment has been made. • The analog video input/output switcher and processor is disabled.



■ Sound mode

- The following sound modes can be selected using the MOVIE, MUSIC, GAME, and PURE buttons.
- Adjust the sound field effect with the menu “Surround Parameter” (see page 123) to enjoy surround sound the way you like it.

Input signal	Sound mode	NOTE	Sound mode		
			MOVIE	MUSIC	GAME
2-channel *1	STEREO		<input type="radio"/>	<input type="radio"/>	<input type="radio"/>
	DOLBY PLII/IIx Cinema	*2	<input type="radio"/>		
	DOLBY PLII/IIx Music	*2		<input type="radio"/>	
	DOLBY PLII/IIx Game	*2			<input type="radio"/>
	DOLBY PLIIz	*2	<input type="radio"/>	<input type="radio"/>	<input type="radio"/>
	DTS NEO:6 Cinema	*2	<input type="radio"/>		
	DTS NEO:6 Music	*2		<input type="radio"/>	
	MULTI CH STEREO		<input type="radio"/>	<input type="radio"/>	<input type="radio"/>
	MONO MOVIE		<input type="radio"/>		
	ROCK ARENA			<input type="radio"/>	
	JAZZ CLUB			<input type="radio"/>	
	MATRIX			<input type="radio"/>	
	VIDEO GAME				<input type="radio"/>
VIRTUAL			<input type="radio"/>	<input type="radio"/>	<input type="radio"/>

*1 2-channel also includes analog input.

*2 This mode plays back 2-channel sources in 5.1 or 7.1-channel playback. It cannot be selected when headphones are used, or when only front speakers are used.



Input signal	Sound mode	NOTE	Sound mode		
			MOVIE	MUSIC	GAME
Multi-channel *3	STEREO		<input type="radio"/>	<input type="radio"/>	<input type="radio"/>
	DOLBY DIGITAL		<input type="radio"/>	<input type="radio"/>	<input type="radio"/>
Dolby Digital	DOLBY DIGITAL EX		<input type="radio"/>	<input type="radio"/>	<input type="radio"/>
	DOLBY DIGITAL + PLIIx Cinema		<input type="radio"/>		
	DOLBY DIGITAL + PLIIx Music			<input type="radio"/>	
	DOLBY DIGITAL + PLIIz		<input type="radio"/>	<input type="radio"/>	<input type="radio"/>
Dolby TrueHD	DOLBY TrueHD		<input type="radio"/>	<input type="radio"/>	<input type="radio"/>
	DOLBY TrueHD + EX		<input type="radio"/>	<input type="radio"/>	<input type="radio"/>
	DOLBY TrueHD + PLIIx Cinema		<input type="radio"/>		
	DOLBY TrueHD + PLIIx Music			<input type="radio"/>	
	DOLBY TrueHD + PLIIz		<input type="radio"/>	<input type="radio"/>	<input type="radio"/>
Dolby Digital Plus	DOLBY DIGITAL Plus		<input type="radio"/>	<input type="radio"/>	<input type="radio"/>
	DOLBY DIGITAL Plus + EX		<input type="radio"/>	<input type="radio"/>	<input type="radio"/>
	DOLBY DIGITAL Plus + PLIIx Cinema		<input type="radio"/>		
	DOLBY DIGITAL Plus + PLIIx Music			<input type="radio"/>	
DTS	DOLBY DIGITAL Plus + PLIIz		<input type="radio"/>	<input type="radio"/>	<input type="radio"/>
	DTS SURROUND		<input type="radio"/>	<input type="radio"/>	<input type="radio"/>
	DTS ES DSCRT 6.1		<input type="radio"/>	<input type="radio"/>	<input type="radio"/>
	DTS ES MTRX 6.1		<input type="radio"/>	<input type="radio"/>	<input type="radio"/>
	DTS 96/24		<input type="radio"/>	<input type="radio"/>	<input type="radio"/>
	DTS + PLIIx Cinema		<input type="radio"/>		
	DTS + PLIIx Music			<input type="radio"/>	
	DTS + PLIIz		<input type="radio"/>	<input type="radio"/>	<input type="radio"/>
DTS + NEO:6		<input type="radio"/>	<input type="radio"/>	<input type="radio"/>	

*3 Some sound modes cannot be selected, depending on the audio format or number of channels of the input signal. For details, see "Types of input signals, and corresponding sound modes" (📖 page 196).



Input signal	Sound mode	NOTE	Sound mode		
			MOVIE	MUSIC	GAME
DTS-HD / DTS Express	DTS-HD HI RES		<input type="radio"/>	<input type="radio"/>	<input type="radio"/>
	DTS-HD MSTR		<input type="radio"/>	<input type="radio"/>	<input type="radio"/>
	DTS Express		<input type="radio"/>	<input type="radio"/>	<input type="radio"/>
	DTS-HD + PLIIx Cinema		<input type="radio"/>		
	DTS-HD + PLIIx Music			<input type="radio"/>	
	DTS-HD + PLIIz		<input type="radio"/>	<input type="radio"/>	<input type="radio"/>
	DTS-HD + NEO:6		<input type="radio"/>	<input type="radio"/>	<input type="radio"/>
PCM multi-channel	MULTI CH IN		<input type="radio"/>	<input type="radio"/>	<input type="radio"/>
	MULTI CH IN 7.1		<input type="radio"/>	<input type="radio"/>	<input type="radio"/>
	MULTI IN + PLIIx Cinema		<input type="radio"/>		
	MULTI IN + PLIIx Music			<input type="radio"/>	
	MULTI IN + PLIIz		<input type="radio"/>	<input type="radio"/>	<input type="radio"/>
	MULTI IN + NEO:6		<input type="radio"/>	<input type="radio"/>	<input type="radio"/>
Multi-channel *3	MULTI CH STEREO		<input type="radio"/>	<input type="radio"/>	<input type="radio"/>
	MONO MOVIE		<input type="radio"/>		
	ROCK ARENA			<input type="radio"/>	
	JAZZ CLUB			<input type="radio"/>	
	MATRIX			<input type="radio"/>	
	VIDEO GAME				<input type="radio"/>
	VIRTUAL		<input type="radio"/>	<input type="radio"/>	<input type="radio"/>

*3 Some sound modes cannot be selected, depending on the audio format or number of channels of the input signal. For details, see "Types of input signals, and corresponding sound modes" (page 196).



■ Views on the display

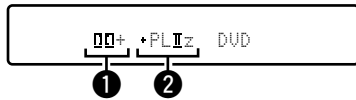

- 1 Shows a decoder to be used.
 - A DOLBY DIGITAL Plus decoder is displayed as "DOLBY DIGITAL Plus".
- 2 Shows a decoder that creates sound output.
 - "+ PLIIz" indicates that the PLIIz decoder is being used, and that front height channel sound is being created.



HDMI control function

A recent addition to the HDMI standard is CEC (Consumer Electronics Control), which allows control signals from one device to communicate with another device via the HDMI cable connection. Not all HDMI-equipped devices have this capability.

Setting procedure

1 Set the HDMI output connector corresponding with the HDMI control function.

Set "HDMI Control" (☞ [page 133](#)) to "On".

2 Turn the power on for all the devices connected by HDMI cable.

3 Set the HDMI control function for all devices connected by HDMI cable.

- Please consult the operating instructions for the connected devices to check the settings.
- Carry out steps 2 and 3 should any of the devices be unplugged.

4 Switch the television input to the HDMI input connected to this unit.

5 Switch the input source of this unit to check that video from the player connected by HDMI is played back correctly.

6 When you turn the TV's power to standby, check that the power of this unit also goes to standby.

NOTE

- Some functions may not operate depending on the connected TV or player. Check the owner's manual of each device for details beforehand.



Sleep timer function

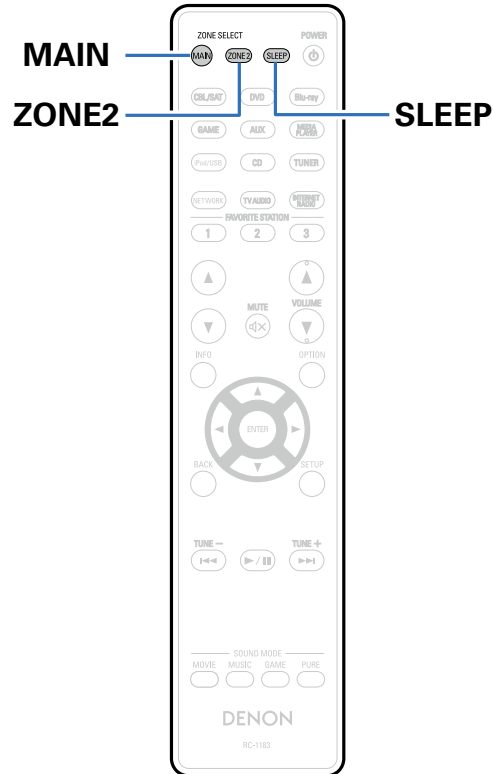

You can have the power automatically switched to standby once a set time has elapsed. This is convenient for viewing and listening while going to sleep.

The sleep timer function can be set for each zone.

Using the sleep timer

- 1 Press MAIN or ZONE2 to switch the zone mode.**
The button for the selected zone is lit.
- 2 Press SLEEP and display the time you want to set.**
 - The SLEEP indicator on the display lights.
 - You can set the sleep timer in the range from 10 to 120 minutes in steps of 10 minutes.

■ To cancel the sleep timer

Press SLEEP to set "Off".

The SLEEP indicator on the display turns off.



- The sleep timer is also cancelled when this unit is set to the standby mode or the MAIN ZONE or ZONE2 power is turned off.

NOTE

- The sleep timer function cannot turn off the power of devices connected to this unit. To turn off the power of those connected devices, set up sleep timers on the connected devices themselves.



Quick select function

You can save settings such as the input source selection, volume level, and sound mode at the QUICK SELECT 1 – 4 buttons. You can simply press one of the set QUICK SELECT buttons for subsequent playback to switch to various saved settings all at once. By saving frequently used settings at the QUICK SELECT 1 – 4 buttons, you will always be able to easily call up the same playback environment.

Calling up the Quick Select

- 1 **Press QUICK SELECT.**
The Quick Select settings for the button you pressed are called up.

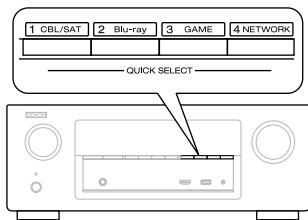

- The default settings of each Quick Select function are as shown below.

Button	Input source	Volume
QUICK SELECT 1	CBL/SAT	40
QUICK SELECT 2	Blu-ray	40
QUICK SELECT 3	GAME	40
QUICK SELECT 4	NETWORK	40

Changing the settings

- 1 **Set the items below to the settings you want to save.**
 - ① Input source* ([🔗 page 42](#))
 - ② Volume ([🔗 page 43](#))
 - ③ Sound mode ([🔗 page 94](#))
 - ④ Audyssey (Audyssey MultEQ® XT, Audyssey Dynamic EQ®, Audyssey Dynamic Volume®) ([🔗 page 128](#))
- 2 **Press and hold the desired QUICK SELECT until “Quick * Memory” appears on the display.**
The current settings will be memorized.
* The number for the QUICK SELECT button you pressed is displayed.

Changing the Quick Select Name

You can change the Quick Select names displayed on the TV or unit of this display to the desired names.

For the name change method, see “Quick Select Names” ([🔗 page 161](#)).



Web control function

You can control this unit from a web control screen on a web browser.

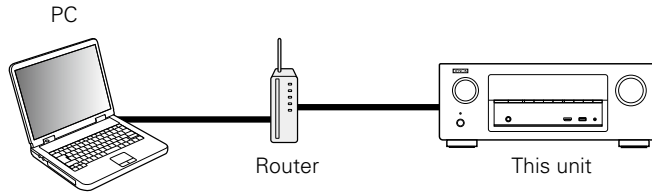

- This unit and the PC need to be connected to the network properly (🔗 page 39 “Connecting to a home network (LAN)”) in order to use the web control function.
- Depending on the settings of your security-related software, you may not be able to access this unit from your PC. If this is the case, then change the settings of the security-related software.

Controlling the unit from a web control

- 1 Switch the “IP Control” (🔗 page 156) setting to “Always On”.
- 2 Check the IP address of this unit with “Information” (🔗 page 156).

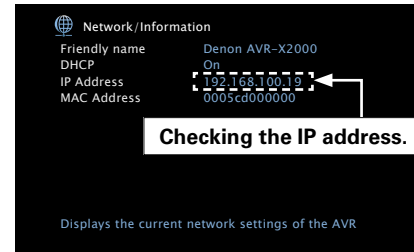

- 3 Start up the web browser.



4 Enter the IP address of this unit in browser's address box.

For example, if the IP address of this unit is "192.168.100.19", enter "http://192.168.100.19".

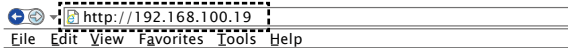

- You can use the Web control function with Internet Explorer 8 or later to memorize and call up various settings on this unit.
To memorize settings, click "SAVE" on the Setup Menu screen.
To call up settings, click "LOAD" on the Setup Menu screen.

5 When the top menu is displayed, click on the menu item you want to operate.

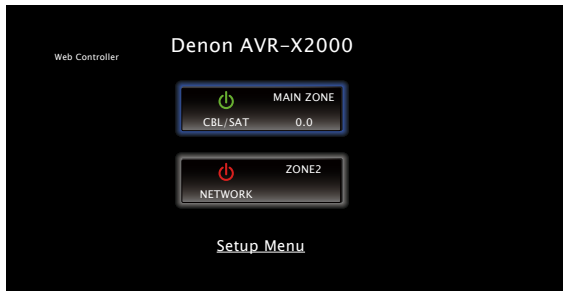

Playback in ZONE2 (Separate room)

You can operate this unit to enjoy audio in a room (ZONE2) that is different from the room where this unit is placed (MAIN ZONE).

You can simultaneously play back the same source in both the MAIN ZONE and ZONE2. You can also play back separate sources in the MAIN ZONE and ZONE2.

Connecting ZONE2

You can use the following two methods to play back audio in ZONE2.

- Connection through the speaker output terminals (🔗 page 110)
- Connection using an external amplifier (🔗 page 111)

■ Connection 1 : Connection through the speaker output terminals

- Set the "Assign Mode" (🔗 page 150) setting to "ZONE2", and outputs ZONE2 audio from SURROUND BACK speaker terminals (The default setting is "Surround Back").
- If you set the "Assign Mode" (🔗 page 150) setting to "ZONE2", the main zone home theater system can play back up to 5.1-channels. Even if you play back audio recorded in 6.1 or 7.1-channels, this unit automatically downmixes the audio to 5.1-channels.

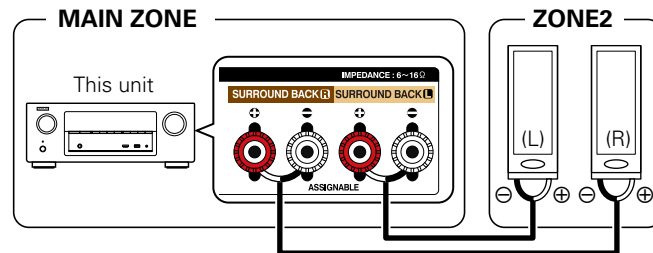

■ Connection 2 : Connection using an external amplifier

The audio signals of this unit's ZONE2 audio output connectors are output to the ZONE2 amplifiers and played on these amplifiers.

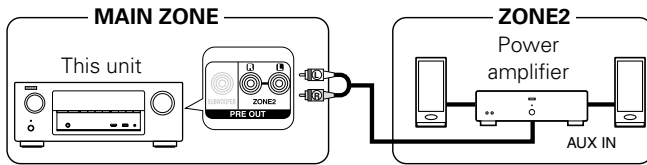

- We recommend using high quality pin-plug (RCA type) cables for audio connections in order to prevent noise.
- If you select a same input source for MAIN ZONE and ZONE2, audio playback may be restricted.



Playback in ZONE2

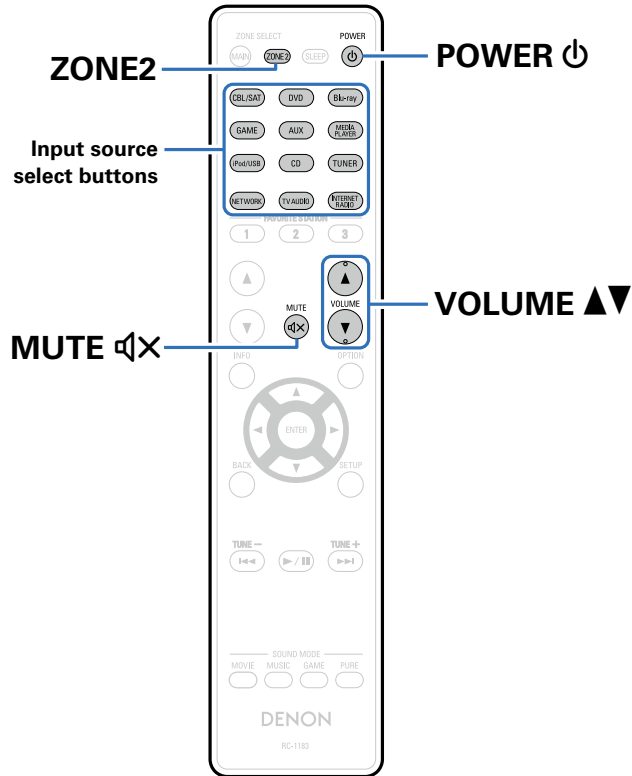

1 Press ZONE2 to switch the zone mode to the ZONE2.

2 Press POWER  to turn on the ZONE2 power.

The **Z2** indicator on the display lights.



- Also press input source select button when in standby mode, the power turns on.
- When POWER  is pressed, ZONE2 turns off.
- Power in ZONE2 can be turned on or off by pressing ZONE2 ON/OFF on the main unit.

3 Press the input source select button to select the input source to be played.

The audio signal of the selected source is output to ZONE2.

- In ZONE2, you can select iPod/USB, TUNER, NETWORK or an input source with an analog audio input connector.
 - To perform an operation with the main unit, press ZONE2 SOURCE.
- Each time you press ZONE2 SOURCE, the input source changes.

■ Adjusting the volume

Use VOLUME   to adjust the volume.

- At time of purchase, "Volume Limit" ( [page 161](#)) is set to "70 (-10dB)".





- Turn MASTER VOLUME after pressing ZONE2 SOURCE on the main unit to adjust the sound volume.



■ Turning off the sound temporarily

Press MUTE .

The sound is reduced to the level set at “Mute Level” ( page 161) in the menu.

- To cancel, either adjust the volume or press MUTE  again.
- You can also adjust the volume level to cancel the muting.



Settings

Menu map

For menu operation, connect a TV to this unit and display the menu on the TV screen. For menu operations, see the following page. By default, this unit has recommended settings defined. You can customize this unit based on your existing system and your preferences.

■ Audio

Setting items	Description	Page
Dialog Level	This setting adjusts the output level to clarify the dialogue output from the center channel.	122
Subwoofer Level	This setting adjusts the volume level for the subwoofer.	122
Subwoofer	Turn subwoofer output on and off.	122
Subwoofer Level	This setting adjusts the volume level for the subwoofer.	122
Surround Parameter	Adjusts surround sound parameters.	123
Cinema EQ	Gently softens the upper treble range of movie soundtracks to reduce possible harshness and improve clarity.	123
Loudness Management	This sets whether to output as specified in "Dynamic Compression" or output directly without compressing the dynamic range of audio recorded in the disc.	123
Dynamic Compression	Compress dynamic range (difference between loud and soft sounds).	123
Low Frequency Effects	Adjust the low frequency effects level (LFE).	124
Center Image	Distributes the dialogue output from the center channel to the front left and right channels and widens the sound image in the front.	124
Panorama	Assign front L/R signals to also go to the surround channels for wider sound.	124
Dimension	Shift sound image center to front or rear to adjust playback balance.	124
Center Width	Distributes the dialogue output from the center channel to left and right channels and widens the sound image in the front.	125
Delay Time	Adjust the audio delay time against video to extend the sound field image.	125
Effect Level	Adjust the sound effect level of the current sound mode.	125
Room Size	Determine size of acoustic environment.	125
Height Gain	Control the front height channel volume.	125



Setting items	Description	Page
Tone	Adjusts the tonal quality of the sound.	126
Tone Control	Set the tone control function to on/off.	126
Bass	Adjust bass.	126
Treble	Adjust treble.	126
Restorer	Expands the low and high frequency components of compressed audio content such as MP3 files to enable richer audio playback.	126
Audio Delay	Compensates for incorrect timing between video and audio.	127
Volume	Set the MAIN ZONE (room where the unit is located) volume setting.	127
Scale	Set how volume is displayed.	127
Limit	Make a setting for maximum volume.	127
Power On Level	Define the volume setting that is active when the power is turned on.	127
Mute Level	Set the amount of attenuation when muting is on.	127
Audyssey	Makes Audyssey MultEQ [®] XT, Audyssey Dynamic EQ [®] and Audyssey Dynamic Volume [®] settings.	128
MultEQ[®] XT	MultEQ [®] XT compensates for both time and frequency characteristics of the listening area based on Audyssey [®] Setup measurement results.	128
Dynamic EQ	Solves the problem of deteriorating sound quality as volume is decreased by taking into account human perception and room acoustics. Works with MultEQ [®] XT.	128
Reference Level Offset	Audyssey Dynamic EQ [®] is referenced to the standard film mix level.	129
Dynamic Volume	Solves the problem of large variations in volume level between TV, movies and other content (between quiet passages and loud passages, etc.) by automatically adjusting to the user's preferred volume setting.	129
Graphic EQ	Uses the graphic equalizer to adjust the tone of each speaker.	130
Speaker Selection	Select whether to adjust tones for individual speakers or for all speakers.	130
Adjust EQ	Adjust tonal balance for each frequency band. Adjust the speaker selected in "Speaker Selection".	130
Curve Copy	Copy "Audyssey Flat" curve from MultEQ [®] XT.	130



■ Video

Setting items	Description	Page
Picture Adjust	Adjusts the video quality.	131
Picture Mode	Select the desired picture mode according to the video content and your viewing environment.	131
Contrast	Adjust picture contrast.	131
Brightness	Adjust picture brightness.	131
Saturation	Adjust picture chroma level (color saturation).	131
Hue	Adjust green and red balance. Also called Tint.	131
Noise Reduction	Reduce overall video noise.	132
Enhancer	Emphasize picture sharpness.	132
HDMI Setup	Makes settings for HDMI video/audio output.	132
Auto Lip Sync	Make automatic compensation for timing shift in audio and video output.	132
HDMI Audio Out	Select HDMI audio output device.	133
HDMI Pass Through	Selects how the AV receiver will pass HDMI signals to the HDMI output in standby power mode.	133
HDMI Control	You can link operations with devices connected to HDMI and compatible with HDMI Control.	133
Pass Through Source	The AV receiver will "pass through" the sources HDMI signal when in standby.	133
Power Off Control	Links the power standby of this unit to external devices.	133
Output Settings	Makes settings for video output.	134
Video Mode	Make settings for video processing.	134
Video Conversion	The input video signal is converted automatically in conjunction with the connected TV.	134
i/p Scaler	Sets the video input signal for which i/p Scaler processing is performed.	134
Resolution	Set the output resolution.	135
Progressive Mode	Set an appropriate progressive conversion mode for the source video signal.	135
Aspect Ratio	Set the aspect ratio for the video signals output to the HDMI.	135
On Screen Display	Select the on-screen display user interface preferences.	136
Volume	Sets where to display the master volume level.	136
Info	Displays status of operation temporarily when the sound mode is changed, or input source is switched.	136
Now Playing	Sets how long each menu is displayed when the input source is "NETWORK", "iPod/USB", or "TUNER".	136
TV Format	Set the video output signal format for the TV you are using.	136



■ Inputs

Setting items	Description	Page
Input Assign	Changes input connector assignment.	137
Source Rename	Changes the display name for input source.	139
Hide Sources	Remove from the display input sources that are not used.	139
Source Level	Adjusts the playback level of the audio input.	139
Input Select	Sets the audio input mode and decode mode.	140
Input Mode	Set the audio input modes for input sources.	140
Decode Mode	Set the audio decode mode for input source.	140

■ Speakers

Setting items	Description	Page
Audyssey® Setup	The acoustic characteristics of the connected speakers and listening room are measured and the optimum settings are made automatically.	141
Manual Setup	Perform when setting the speakers manually or when changing settings made in Audyssey® Setup.	150
Amp Assign	Select power amplifier usage method to match your speaker system.	150
Speaker Config.	Indicate speaker presence and select speaker size categories based on bass reproduction capability.	151
Distances	Set distance from listening position to speakers.	153
Levels	Set the volume of the test tone to be the same when it is output from each speaker.	153
Crossovers	Set the maximum frequency of the bass signal output from each channel to the subwoofer.	154
Bass	Set subwoofer and LFE signal range playback.	155
Front Speaker Setup	Set the front speaker A/B to use for every sound mode.	155



■ Network

Setting items	Description	Page
Information	Display network information.	156
IP Control	Enables network communication in standby power mode.	156
Friendly Name	The Friendly Name is the name of this unit displayed on the network. You can change the Friendly Name according to your preferences.	156
Settings	Make settings for wired LAN.	157
Diagnostics	Used to check the network connection.	158
Maintenance Mode	Use when receiving maintenance from a Denon service engineer or custom installer.	159

■ General

Setting items	Description	Page
Language	Sets the language for display the menu on the TV screen.	160
ZONE2 Setup	Makes settings for audio playback with multi-zone (ZONE2).	160
Lch Level	Adjust the left channel output level.	160
Rch Level	Adjust the right channel output level.	160
Volume Level	Set the volume output level.	160
Volume Limit	Make a setting for maximum volume.	161
Power On Volume	Define the volume setting that is active when the power is turned on.	161
Mute Level	Set the amount of attenuation when muting is on.	161
Zone Rename	Change the display title of each zone to one you prefer.	161
Quick Select Names	Change the "Quick Select" display title to one you prefer.	161
Auto Standby	Sets the time for switching to auto standby when there are no audio or video signals input into this unit.	162
Front Display	Makes settings related to the display on this unit.	162



Setting items	Description	Page
Information	Show information about receiver settings, input signals, etc.	162
Audio	Shows information about audio input signals.	162
Video	Shows information about video input signal and HDMI Monitor.	163
ZONE	Shows information about each zone.	163
Firmware	Displays system information.	163
Notifications	Displays and sets notifications from Denon.	163
Usage Data	Selects whether or not to send anonymous usage data to Denon.	164
Firmware	Checks for the latest firmware information about updates and upgrades, updates the firmware, and sets up the notification message display.	164
Update	Update the firmware of the receiver.	164
Notifications	Sets whether or not to display a notification message when new firmware is released.	165
Add New Feature	Display new features that can be downloaded to this unit and perform an upgrade.	165
Setup Lock	Protect settings from inadvertent changes.	166

■ Setup Assistant

Setting items	Description	Page
Begin Setup	Perform basic installation/connections/settings from the beginning according to the guidance indicated on the TV screen.	 7
Language Select	Perform settings item by item according to the guidance indicated on the TV screen.	
Speaker Setup		
Speaker Calibration		
Network Setup		
Input Setup		



Menu operation

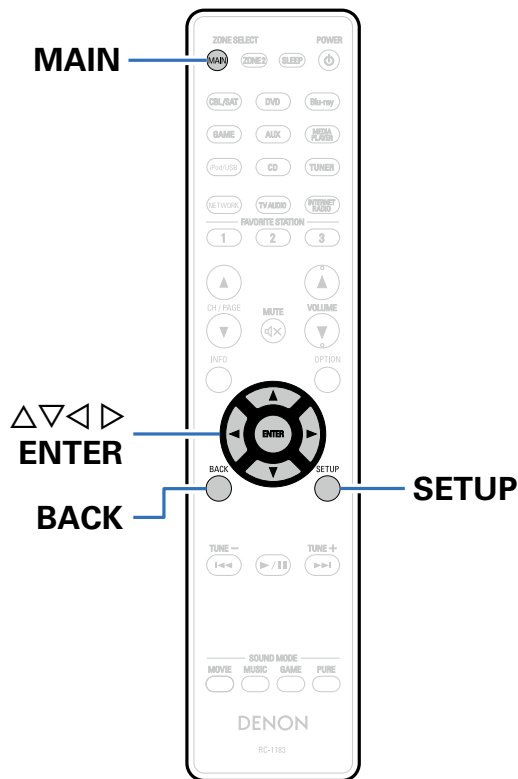

- 1 Press MAIN to switch the zone mode.**
MAIN lights.
- 2 Press SETUP.**
The menu is displayed on the TV screen.
- 3 Use $\Delta \nabla \triangleleft \triangleright$ to select the menu to be set or operated, then press ENTER.**
- 4 Use $\triangleleft \triangleright$ to change to desired setting.**
- 5 Press ENTER to enter the setting.**
 - To return to the previous item, press BACK.
 - Exiting the Menu, press SETUP while the menu is displayed. The menu display disappears.



Inputting characters

On this unit, you can change the name displayed on the following screens to the names that you prefer.

- Preset Name (🔗 page 58)
- Text Search (🔗 page 89)
- Source Rename (🔗 page 139)
- Friendly Name (🔗 page 156)
- Zone Rename (🔗 page 161)
- Quick Select Names (🔗 page 161)
- Character input for the network functions (🔗 page 61, 68, 73, 77, 157)

Keyboard screen

1 Display the screen for inputting characters.

[Example] Source Rename screen



2 Select a character to be changed.

- ① Use $\Delta \nabla \triangleleft \triangleright$ to select “←” or “→”.
- ② Press ENTER to place the cursor at the character to be changed.

Each time ENTER is pressed, the cursor moves by one character.

3 Select a character to be input with $\Delta \nabla \triangleleft \triangleright$ then press ENTER.

4 Repeat steps 2 and 3 to change the name.

5 Use $\Delta \nabla \triangleleft \triangleright$ to select “OK”, then press ENTER.



Audio

Make audio-related settings.

Dialog Level

This setting adjusts the output level to clarify the dialogue output from the center channel.

■ Level

-12.0dB – +12.0dB (Default : 0.0dB)

Subwoofer Level

This setting adjusts the volume level for the subwoofer.

■ Subwoofer

Turn subwoofer output on and off.

On (Default) : The subwoofer is used.

Off : The subwoofer is not used.



- This can be set when the sound mode is "DIRECT" and the "Subwoofer Mode" ( [page 155](#)) is "LFE+Main".

■ Subwoofer Level

This setting adjusts the volume level for the subwoofer.

-12.0dB – +12.0dB (Default : 0.0dB)



Surround Parameter

You can adjust the surround audio sound field effects to match your preferences.

The items (parameters) that can be adjusted depend on the signal being input and the currently set sound mode. For details on the adjustable parameters, see “Sound modes and surround parameters” (🔍 page 193).



- Some setting items cannot be set while playback is stopped. Make the settings during playback.

■ Cinema EQ

Gently softens the upper treble range of movie soundtracks to reduce possible harshness and improve clarity.

On : “Cinema EQ” is used.

Off (Default) : “Cinema EQ” is not used.

■ Loudness Management

This sets whether to output as specified in “Dynamic Compression” or output directly without compressing the dynamic range of audio recorded in the disc.

On (Default) : Outputs using the settings made in “Dynamic Compression” and “Dialogue normalization function” (🔍 page 162) are enabled.

Off : “Dynamic Compression” settings and “Dialogue Normalization” are disabled, and the signals on the disk are output as is.



- This can be set in the Dolby TrueHD mode.

■ Dynamic Compression

Compress dynamic range (difference between loud and soft sounds).

Auto : Automatic dynamic range compression on/off control according to source.

Low / Medium / High : These set the compression level.

Off : Dynamic range compression is always off.



- You can set “Auto” only for the Dolby TrueHD source.
- The default setting is “Off”. When the input signal is Dolby TrueHD source, the default setting is “Auto”.



■ Low Frequency Effects

Adjust the low-frequency effects level (LFE).

-10dB – 0dB (Default)



- For proper playback of the different sources, we recommend setting to the values below.
- Dolby Digital sources : 0dB
- DTS movie sources : 0dB
- DTS music sources : -10dB

■ Center Image

Distributes the dialogue output from the center channel to the front left and right channels and widens the sound image in the front.

0.0 – 1.0 (Default : 0.3)



- You can set this when the sound mode is set to DTS NEO:6 Music.
- The smaller the value, the more dialogue is concentrated on the center channel. The larger the value, the more dialogue is distributed to front left and right channels, and the more the sound image widens in the front.

■ Panorama

Assign front L/R signals to also go to the surround channels for wider sound.

On : Set.

Off (Default) : Do not set.



- You can set this when the sound mode is Dolby PLII/IIx in the "Music" mode.

■ Dimension

Shift sound image center to front or rear to adjust playback balance.

0 – 6 (Default : 3)



- You can set this when the sound mode is Dolby PLII/IIx in the "Music" mode.
- As you set a smaller number, the surround sound field shifts backward; as you set a larger number, the surround sound field shifts forward.



■ Center Width

Distributes the dialogue output from the center channel to left and right channels and widens the sound image in the front.

0 – 7 (Default : 3)



- You can set this when the sound mode is Dolby PLII/IIx in the “Music” mode.
- The smaller the value, the more dialogue is concentrated on the center channel. The larger the value, the more dialogue is distributed to front left and right channels, and the more the sound image widens in the front.

■ Delay Time

Adjust the audio delay time against video to extend the sound field image.

0ms – 300ms (Default : 30ms)



- You can set this when the sound mode is “MATRIX”.

■ Effect Level

Adjust the sound effect level of the current sound mode.

1 – 15 (Default : 10)



- Set to a lower level if the positioning and sense of phase of the surround signals seems unnatural.

■ Room Size

Determine size of acoustic environment. You can set this when the sound mode is one of the original sound modes.

Small : Simulate acoustics of a small room.

Medium small : Simulate acoustics of a medium-small room.

Medium (Default) : Simulate acoustics of a medium room.

Medium large : Simulate acoustics of a medium-large room.

Large : Simulate acoustics of a large room.



- “Room Size” does not indicate the size of the room in which sources are played.

■ Height Gain

Control the front height channel volume.

Low : Reduce the front height channel volume.

Normal (Default) : Front height channel sound is output with standard sound volume.

High : Increase the front height channel volume.



- You can set this in the “PLIIz” sound mode or when using the PLIIz decoder.

■ Set Defaults

The “Surround Parameter” settings are returned to the default settings.



Tone

Adjust the tonal quality of the sound.

■ Tone Control

Set the tone control function to on/off.

On : Allow tone adjustment (bass, treble).

Off (Default) : Playback without tone adjustment.

■ Bass

Adjust bass.

-6dB – +6dB (Default : 0dB)

■ Treble

Adjust treble.

-6dB – +6dB (Default : 0dB)



- This cannot be set when the sound mode is set to "DIRECT" or "PURE DIRECT".

Restorer

Compressed audio formats such as MP3, WMA (Windows Media Audio) and MPEG-4 AAC reduce the amount of data by eliminating signal components that are hard for the human ear to hear. The "Restorer" function generates the signals eliminated upon compression, restoring the sound to conditions near those of the original sound before compression. It also restores the original bass characteristics for a rich and expanded tonal range.

■ Mode

High : Optimized mode for compressed sources with very weak highs (64 kbps and under).

Medium : Apply suitable bass and treble boost for all compressed sources (96 kbps and under).

Low : Optimized mode for compressed sources with normal highs (96 kbps and over).

Off : Do not use "Restorer".



- This item can be set with analog signals or PCM signal (Sample Rate = 44.1/48 kHz) is input.
- "Restorer" settings are stored for each input source.
- This item default setting for "NETWORK" and "iPod/USB" is "Low". All others are set to "Off".
- This cannot be set when the sound mode is set to "DIRECT" or "PURE DIRECT".



Audio Delay

While viewing video, manually adjust the time to delay audio output so that the video and audio are synchronized.

0ms (Default) – **200ms**



- This item can be set within the range of 0 to 100 ms when “Auto Lip Sync” (🔗 [page 132](#)) is set to “On” and when a TV compatible with Auto Lip Sync is connected.
- Store “Audio Delay” for each input source.
- Audio Delay for game mode can be set when “Video Mode” (🔗 [page 134](#)) is set to “Auto” or “Game”.

Volume

Set the MAIN ZONE (room where the unit is located) volume setting.

■ Scale

Set how volume is displayed.

0 – 98 (Default) : Display in the range 0 (Min) to 98.

–79.5dB – 18.0dB : Display –dB (Min), in the range –79.5 dB to 18.0 dB.



- The “Scale” setting applies to all zones.

■ Limit

Make a setting for maximum volume.

60 (–20dB) / 70 (–10dB) / 80 (0dB)

Off (Default)

■ Power On Level

Define the volume setting that is active when the power is turned on.

Last (Default) : Use the memorized setting from the last session.

Mute : Always use the muting on condition when power is turned on.

1 – 98 (–79dB – 18dB) : The volume is adjusted to the set level.

■ Mute Level

Set the amount of attenuation when muting is on.

Full (Default) : The sound is muted entirely.

–40dB : The sound is attenuated by 40 dB down.

–20dB : The sound is attenuated by 20 dB down.



Audyssey

Set Audyssey MultEQ® XT, Audyssey Dynamic EQ® and Audyssey Dynamic Volume®. These can be selected after Audyssey® Setup has been performed. For additional information on Audyssey technology, please see [page 199](#).



- “MultEQ® XT”, “Dynamic EQ” and “Dynamic Volume” settings are stored for each input source.
- “MultEQ® XT”, “Dynamic EQ” and “Dynamic Volume” cannot be set when the sound mode is set to “DIRECT” or “PURE DIRECT”.

■ MultEQ® XT

MultEQ® XT compensates for both time and frequency characteristics of the listening area based on Audyssey® Setup measurement results. Selection is done from three types of compensation curves. We recommend the “Audyssey” setting.

Audyssey (Default) : Optimize the frequency response of all speakers.

Audyssey Byp. L/R : Optimize frequency response of speakers except front L and R speakers.

Audyssey Flat : Optimize frequency response of all speakers to flat response.

Graphic EQ : Apply frequency response set with “Graphic EQ” ([page 130](#)).

Off : Turn “MultEQ® XT” equalizer off.



- When using headphones, “MultEQ® XT” is automatically set to “Off”.

■ Dynamic EQ

Solves the problem of deteriorating sound quality as volume is decreased by taking into account human perception and room acoustics. Works with MultEQ® XT.

On (Default) : Use Dynamic EQ.

Off : Do not use Dynamic EQ.



- When the menu “Dynamic EQ” setting is “On”, it is not possible to do “Tone Control” ([page 126](#)) adjustment.



■ Reference Level Offset

Audyssey Dynamic EQ® is referenced to the standard film mix level. It makes adjustments to maintain the reference response and surround envelopment when the volume is turned down from 0 dB. However, film reference level is not always used in music or other non-film content. Dynamic EQ Reference Level Offset provides three offsets from the film level reference (5 dB, 10 dB, and 15 dB) that can be selected when the mix level of the content is not within the standard. Recommended setting levels for content are shown below.

0dB (Film Ref) (Default) : Optimized for content such as movies.

5dB : Select this setting for content that has a very wide dynamic range, such as classical music.

10dB : Select this setting for jazz or other music that has a wider dynamic range. This setting should also be selected for TV content as that is usually mixed at 10 dB below film reference.

15dB : Select this setting for pop/rock music or other program material that is mixed at very high listening levels and has a compressed dynamic range.



- Setting is enabled when “Dynamic EQ” ([🔍 page 128](#)) is “On”.

■ Dynamic Volume

Solves the problem of large variations in volume level between TV, movies and other content (between quiet passages and loud passages, etc.) by automatically adjusting to the user’s preferred volume setting.

Heavy : Most adjustment to softest and loudest sounds.

Medium : Medium adjustment to loudest and softest sound.

Light : Least adjustment to loudest and softest sounds.

Off (Default) : Do not use “Dynamic Volume”.



- If “Dynamic Volume” is set to “Yes” in “Audyssey® Setup” ([🔍 page 141](#)), the setting is automatically changed to “Medium”.



Graphic EQ

Use the 9 band graphic equalizer to adjust the tone of each speaker.



- “Graphic EQ” can be set when “MultEQ® XT” ([page 128](#)) setting is “Graphic EQ”.
- Speakers for which “Graphic EQ” can be set differ according to the sound mode.

■ Speaker Selection

Select whether to adjust tones for individual speakers or for all speakers.

All

Left/Right (Default)

Each

■ Adjust EQ

Adjust tonal balance for each frequency band. Adjust the speaker selected in “Speaker Selection”.

- ① Select the speaker.
- ② Select the adjustment frequency band.
63Hz / 125Hz / 250Hz / 500Hz / 1kHz / 2kHz / 4kHz / 8kHz / 16kHz
- ③ Adjust the level.
-20.0dB – +6.0dB (Default : 0.0dB)

■ Curve Copy

Copy “Audyssey Flat” curve from “MultEQ® XT” ([page 128](#)).



- “Curve Copy” is displayed after Audyssey® Setup has been performed.

■ Set Defaults

The “Graphic EQ” settings are returned to the default settings.



Video

Make video-related settings.

Picture Adjust

Picture quality can be adjusted.



- Can be set when the “Video Conversion” (🔗 page 134) setting is “On”.
- Can be set when “HDMI”, “COMP” or “VIDEO” (🔗 page 138) is assigned for each input source.

Picture Mode

Select the desired picture mode according to the video content and your viewing environment.

Standard : The standard mode suited for most living room viewing environments.

Movie : A mode suited for watching movies in a dark room such as a theater room.

Vivid : A mode that makes graphic images for games, etc. brighter and more vivid.

Streaming : A mode suited for low bit rate video sources.

Custom : Adjusts the picture quality manually.

Off : No picture quality adjustment is done with this unit.



- You can also press OPTION to make these settings from “Picture Mode” (🔗 page 92) in the option menu.
- The default settings are as follows.
 - For “NETWORK” and “iPod/USB” input sources : Streaming
 - For input sources other than “NETWORK” and “iPod/USB” : Off

Contrast

Adjust picture contrast.

-6 – +6 (Default : 0)

Brightness

Adjust picture brightness.

0 (Default) **- +12**

Saturation

Adjust picture chroma level (color saturation).

-6 – +6 (Default : 0)

Hue

Adjust green and red balance. Also called Tint.

-6 – +6 (Default : 0)



■ Noise Reduction

Reduce overall video noise.

Low / Medium / High / Off (Default)

■ Enhancer

Emphasize picture sharpness.

0 (Default) – **+12**



- “Contrast”, “Brightness”, “Saturation”, “Hue”, “Noise Reduction” and “Enhancer” can be set when “Picture Mode” is set to “Custom”.
- “Picture Adjust” can not be set when 4K signals are input.

HDMI Setup

Make settings for HDMI video/audio output.

NOTE

- When “HDMI Pass Through” and “HDMI Control” is set to “On”, it consumes more standby power. If you are not using this unit for an extended period, it is recommended that you unplug the power cord from the power outlet.

■ Auto Lip Sync

Make automatic compensation for timing shift in audio and video output.

On (Default) : Compensated.

Off : Not compensated.

■ HDMI Audio Out

Select HDMI audio output device.

AVR (Default) : Play back through speakers connected to the unit.

TV : Play back through TV connected to the unit.



- When the HDMI control function is activated, priority is given to the TV audio setting (see page 105 “HDMI control function”).
- When the power of this unit is on and “HDMI Audio Out” is set to “TV”, audio is output as 2-channel from the HDMI OUT connector.



■ HDMI Pass Through

Selects how the AV receiver will pass HDMI signals to the HDMI output in standby power mode.

On : Passes the selected HDMI input through the AV receiver's HDMI output when the AV receiver is in standby power mode.

Off (Default) : No HDMI signals are passed through the AV receiver's HDMI output in standby power mode.

■ HDMI Control

You can link operations with devices connected to HDMI and compatible with HDMI Control.

On : Use HDMI control function.

Off (Default) : Do not use HDMI control function.



- Please consult the operating instructions for each connected device to check the settings.
- Refer to "HDMI control function" ( page 105) for more information about the HDMI control function.

NOTE

- If the "HDMI Control" settings have been changed, always reset the power to connected devices after the change.

■ Pass Through Source

The AV receiver will "pass through" the source's HDMI signal when in standby.

Last (Default) : Choose this option to "pass through" the last used HDMI input video source.

CBL/SAT / DVD / Blu-ray / GAME / AUX / MEDIA PLAYER / CD* : Choose this option to "pass through" the selected input source when in standby.

* "Pass Through Source" can be set when any of the HDMI connectors is assigned to "CD" for the input source in the "Input Assign" ( page 137) setting.



- "Pass Through Source" can be set when "HDMI Control" is set to "On" or "HDMI Pass Through" is set to "On".

■ Power Off Control

Links the power standby of this unit to external devices.

All (Default) : If power to a connected TV is turned off independently of the input source, power to this unit is automatically set to standby.

Video : With an input source being selected that is assigned either "HDMI", "COMP" or "VIDEO" ( page 138), when you turn the power of the TV off, power to this unit is automatically set to standby.

Off : This unit does not link with power to a TV.



Output Settings

Makes settings for video output.



- Can be set when each input source is assigned "HDMI", "COMP" or "VIDEO" (see page 138).
- "Resolution", "Progressive Mode" and "Aspect Ratio" can be set when "i/p Scaler" is set to anything other than "Off".
- "Output Settings" can not be set when 4K signals are input.

■ Video Mode

Make settings for video processing.

Auto (Default) : Process video automatically based on the HDMI content information.

Game : Always process video for game content.

Movie : Always process video for movie content.



- If "Video Mode" is set to "Auto", the mode is switched according to the input contents.

■ Video Conversion

The input video signal is converted automatically in conjunction with the connected TV (see page 187 "Video conversion function").

On (Default) : The input video signal is converted.

Off : The input video signal is not converted.

■ i/p Scaler

Sets the video input signal for which i/p Scaler processing is performed.

- When the input source is set other than to "iPod/USB" and "NETWORK"**

Analog (Default) : Use i/p (interlace-to-progressive) scaler function for analog video signals.

Analog & HDMI : Use i/p scaler function for analog and HDMI video signal.

HDMI : Use i/p scaler function for HDMI video signals.

Off : Do not use i/p scaler function.

- When the input source is set to "iPod/USB" and "NETWORK"**

On (Default) : Use i/p scaler function.

Off : Do not use i/p scaler function.



- "Analog & HDMI" can be set for input sources for which an HDMI input connector is assigned.
- Which items can be set depend on the input source assigned to each input connector.
- This function is not effective when the input signal is "x.v.Color", 3D, sYCC 601 color, Adobe RGB color, Adobe YCC 601 color or computer resolutions.



Resolution

Set the output resolution.

You can set "Resolution" separately for HDMI output of the analog video input and HDMI input.

Auto (Default) : The number of pixels the TV connected to the HDMI MONITOR OUT connector supports is detected automatically and the appropriate output resolution is set.

480p/576p / 1080i / 720p / 1080p / 1080p:24Hz / 4K :

Set the output resolution.



- When "i/p Scaler" is set to "Analog & HDMI", the resolution of both the analog video input signal and HDMI input signal can be set.
- When set to "1080p:24Hz", you can enjoy film-like pictures for film sources (in 24 Hz). For video sources and mixed sources, we recommend setting the resolution to "1080p".
- It is not possible to convert a 50 Hz signal into 1080p/24Hz. It is output at a resolution of 1080p/50Hz.

Progressive Mode

Set an appropriate progressive conversion mode for the source video signal.

Auto (Default) : The video signal is automatically detected and the appropriate mode is set.

Video : Select mode suitable for video playback.

Video and Film : Select mode suitable for video and 30-frame film material playback.



- This item can be set when "i/p Scaler" is set to anything other than "Off".

Aspect Ratio

Set the aspect ratio for the video signals output to the HDMI.

16:9 (Default) : Output at 16:9 aspect ratio.

4:3 : Output at 4:3 aspect ratio with black bars on the sides of a 16:9 TV screen (except for 480p/576p output).



- "Aspect Ratio" can be set when "i/p Scaler" is set to anything other than "Off".



On Screen Display

Select the on-screen display user interface preferences.

■ Volume

Sets where to display the master volume level.

Bottom (Default) : Display at the bottom.

Top : Display at the top.

Off : Turn display off.



- When the master volume display is hard to see when superimposed text (closed captioning) or movie subtitles are present, set to "Top".

■ Info

Displays status of operation temporarily when the sound mode is changed, or input source is switched.

On (Default) : Turn display on.

Off : Turn display off.

■ Now Playing

Sets the display time for the playback display when the input source is "NETWORK", "iPod/USB" or "TUNER".

Always On (Default) : Show display continuously.

Auto Off : Show display for 30 seconds after operation.

TV Format

Set the video signal format to be output for the TV you are using.

■ Format

PAL (Default) : Select PAL output.

NTSC : Select NTSC output.



- "Format" can also be set by the following procedure. However, the menu screen is not displayed.
 1. Press and hold the main unit's ZONE2 SOURCE and STATUS for at least 3 seconds.
"V.Format:<PAL>" appears on the display.
 2. Use the main unit's TUNER PRESET CH +, - and set the video signal format.
 3. Press the main unit's STATUS to complete the setting.

NOTE

- When a format other than the video format of the connected TV is set, the picture will not be displayed properly.



Inputs

Perform settings related to input source playback.

You do not have to change the settings to use the unit. Make settings when needed.

Input Assign

By making connections as indicated by the input sources printed on the audio/video input connectors of this unit, you can just press one of the input source select buttons to easily play back audio or video from a connected device.

If you have made connections that are different to the default settings, the HDMI input connectors, digital audio input connectors, analog audio input connectors, component video input connectors and video input connectors assigned to each input source can be changed using these items.

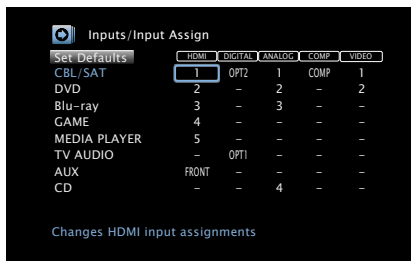

- By default, each item is set as follows.

Input source	HDMI	DIGITAL	ANALOG	COMP	VIDEO
CBL/SAT	1	OPT2	1	COMP	1
DVD	2	-	2	-	2
Blu-ray	3	-	3	-	-
GAME	4	-	-	-	-
MEDIA PLAYER	5	-	-	-	-
TV AUDIO	-	OPT1	-	-	-
AUX	FRONT	-	-	-	-
CD	-	-	4	-	-

TV set top box/satellite users please note

When using the optical digital audio output on a TV/satellite box :
To play the video signal assigned to "HDMI" combined with the audio signal assigned at "Input Assign" - "DIGITAL", you will also need to select "Digital" in the "Input Mode" (page 140).



■ HDMI

Set this to change the HDMI input connectors assigned to the input sources.

1 / 2 / 3 / 4 / 5 / 6 / FRONT : Assign an HDMI input connector to the selected input source.

– : Do not assign an HDMI input connector to the selected input source.



- When “HDMI Control” (🔑 page 133) is set to “On”, HDMI input connector cannot be assigned to “TV AUDIO”.

■ DIGITAL

Set this to change the digital audio input connectors assigned to the input sources.

OPT1 (Optical) / **OPT2** :

Assign a digital audio input connector to the selected input source.

– : Do not assign a digital audio input connector to the selected input source.

■ ANALOG

Set this to change the analog audio input connectors assigned to the input sources.

1 / 2 / 3 / 4 : Assign a analog audio input connector to the selected input source.

– : Do not assign a analog audio input connector to the selected input source.

■ COMP (Component video)

Set this to change the component video input connectors assigned to the input sources.

COMP : Assign the component video input connector to the selected input source.

– : Do not assign a component video input connector to the selected input source.

■ VIDEO

Set this to change the composite video input connectors assigned to the input sources.

1 / 2 : Assign the video input connector to the selected input source.

– : Do not assign a video input connector to the selected input source.

■ Set Defaults

The “Input Assign” settings are returned to the default settings.



Source Rename

Change the display name for input source.

This is convenient when the name of your device and the input source name of this unit are different. You can change the name to suit your needs. When the renaming is completed, the name is displayed on this unit's display and on the menu screen.

CBL/SAT / DVD / Blu-ray / GAME / AUX / MEDIA PLAYER / CD / TV AUDIO : Change the display name of the selected input source.

Set Defaults : The "Source Rename" settings are returned to the default settings.



- Up to 12 characters can be input. For character input, see [page 121](#).

Hide Sources

Remove from the display input sources that are not used.

Show (Default) : Use this source.

Hide : Do not use this source.

Source Level

This function corrects the playback level of the selected input source's audio input.

Make this setting if there are differences in the input volume levels between the different sources.

-12dB – +12dB (Default : 0dB)



Input Select

Set the audio input mode and decode mode of each input source.
The input modes available for selection may vary depending on the input source.

Input Mode

Set the audio input modes for the different input sources.

It is normally recommended to set the audio input mode to "Auto".

Auto (Default) : Automatically detect input signal and perform playback.

HDMI : Play only signals from HDMI input.

Digital : Play only signals from digital audio input.

Analog : Play only signals from analog audio input.



- When digital signals are properly input, the **DIG** indicator lights on the display.
If the **DIG** indicator does not light, check "Input Assign" (page 137) and the connections.
- If "HDMI Control" is set to "On" and a TV compatible with the ARC is connected via the HDMI MONITOR connectors, the input mode whose input source is "TV AUDIO" is fixed to ARC.

Decode Mode

Set the audio decode mode for input source.

Auto (Default) : Detect type of digital audio input signal and decode and play automatically.

PCM : Decode and play only PCM input signals.

DTS : Decode and play only DTS input signals.



- This item can be set for input sources for which "HDMI" or "DIGITAL" is assigned at "Input Assign" (page 137).
- Normally set this mode to "Auto". It is recommended to set "PCM" or "DTS" when audio is missing at the beginning or a noise occurs.



Speakers

The acoustic characteristics of the connected speakers and listening room are measured and the optimum settings are made automatically. This is called “Audyssey® Setup”.

You do not have to perform Audyssey® Setup when you have already performed Speaker Calibration in Setup Assistant.

To set up the speakers manually, use “Manual Setup” ( [page 150](#)) on the menu.

Audyssey® Setup

To perform measurement, place the Setup and measurement microphone in multiple locations all around the listening area. For best results, we recommend you measure in six or more positions, as shown in the illustration (up to eight positions).



- When performing Audyssey® Setup, Audyssey MultEQ® XT/Audyssey Dynamic EQ®/Audyssey Dynamic Volume® functions become active ( [page 128, 129](#)).

NOTE

- Make the room as quiet as possible. Background noise can disrupt the room measurements. Close windows and turn off the power on electronic devices (TVs, radios, air conditioners, fluorescent lights, etc.). The measurements could be affected by the sounds emitted by such devices.
- During the measurement process, place cell phones outside the listening room. Cell phone signals could disrupt the measurements.
- Do not stand between the speakers and Setup and measurement microphone or allow obstacles in the path while the measurements are being made. Do not hold the Setup and measurement microphone in your hand during measurements. This will cause inaccurate readings.
- During the measurement process, audible test tones will come from the speakers and subwoofer(s), but this is part of normal operation. If there is background noise in the room, these test signals will increase in volume.
- Operating VOLUME ▲▼ on the remote control unit or MASTER VOLUME on the main unit during the measurements will cancel the measurements.
- Measurement cannot be performed when headphones are connected. Unplug the headphones before performing Audyssey® Setup.



■ About Setup and measurement microphone placement

- Measurements are performed by placing the Setup and measurement microphone successively at multiple positions throughout the entire listening area, as shown in **[Example ①]**.
- Even if the listening environment is small as shown in **[Example ②]**, measuring at multiple points throughout the listening environment results in more effective correction.

[Example ①]

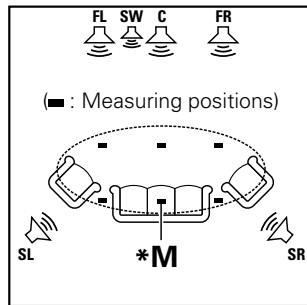

[Example ②]

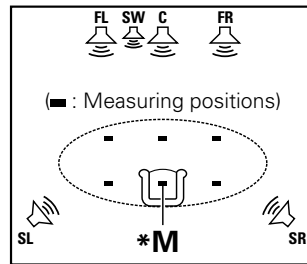

FL Front speaker (L)
FR Front speaker (R)
C Center speaker

SW Subwoofer
SL Surround speaker (L)
SR Surround speaker (R)

■ About the main listening position (*M)

The main listening position is the position where listeners would normally sit or where one would normally sit alone within the listening environment. Before starting Audyssey® Setup, place the Setup and measurement microphone in the main listening position. Audyssey MultEQ® XT uses the measurements from this position to calculate speaker distance, level, polarity, and the optimum crossover value for the subwoofer.



Procedure for speaker settings (Audyssey® Setup)

Preparation



Measurement



Calculation



Check



Store



Finish

1 Mount the Setup and measurement microphone on a tripod or stand and place it in the main listening position.

When you set the setup microphone, point the tip of it toward the ceiling, at the height of your ears in your listening position.

2 If using a subwoofer capable of the following adjustments, set up the subwoofer as shown below.

- When using a subwoofer with a direct mode
Set the direct mode to "On" and disable the volume adjustment and crossover frequency setting.
- When using a subwoofer without a direct mode
Make the following settings:
 - Volume : "12 o'clock position"
 - Crossover frequency : "Maximum/Highest Frequency"
 - Low pass filter : "Off"
 - Standby mode : "Off"



3 Connect the Setup and measurement microphone to the SETUP MIC jack of this unit.

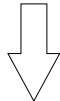
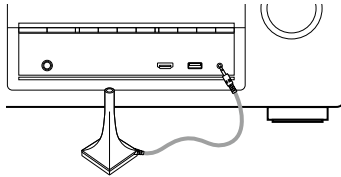

When the Setup and measurement microphone is connected, the following screen is displayed.

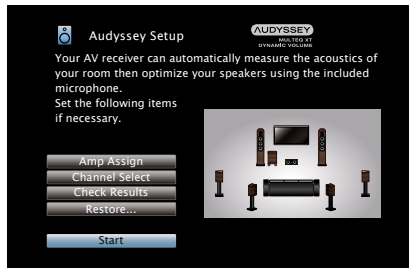

4 Select "Start" and then press ENTER.

Audyssey® Setup can also make the following settings.

• Amp Assign

The signals output from the SURROUND BACK speaker terminals can be switched in accordance with your speaker environment. Refer to "Amp Assign" (🔍 page 150).

• Channel Select

If channels that are not to be used are set in advance, measurement for the set channels is skipped, and measuring time can be reduced. You can also change the number of surround back speakers.

5 Select "Next" and then press ENTER.

6 Select "Begin Test" and then press ENTER.

- Measurement requires several minutes.

NOTE

• If "Caution!" is displayed on TV screen:

Go to "Error messages" (🔍 page 148). Check any related items, and perform the necessary procedures.

☐ When measuring has stopped

- ① Press BACK to display the popup screen.
- ② Press < to select "Yes", and then press ENTER.



7 The detected speakers are displayed.

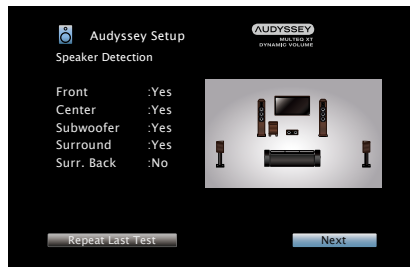

8 Select "Next" and then press ENTER.

9 Move the Setup and measurement microphone to position 2, select "Continue", and then press ENTER.

The measurement of the second position starts. Measurements can be made in up to eight positions.



- To skip measuring the second and subsequent listening position, press ∇ to select "Calculation" and press ENTER to proceed to step 12.



10 Repeat step 9, measuring positions 3 to 8.

11 Select "Calculation" and then press ENTER.

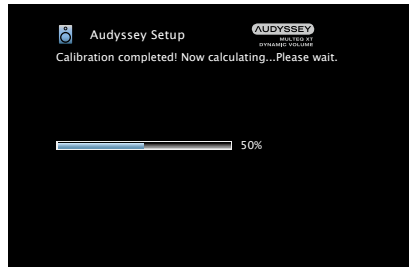

- Analysis takes several minutes to complete. The more speakers and measurement positions that there are, the more time it takes to perform the analysis.

12 Use Δ / ∇ to select the item you want to check, and then press ENTER.



- Subwoofers may measure a greater reported distance than the actual distance due to added electrical delay common in subwoofers.



13 Select "Store" and then press ENTER.

Save the measurement results.



- Saving the results requires about 20 seconds.

NOTE

- During saving of measurement results, be sure not to turn off the power.

14 Unplug the Setup and measurement microphone from the unit's SETUP MIC jack.

15 Set Audyssey Dynamic Volume®.

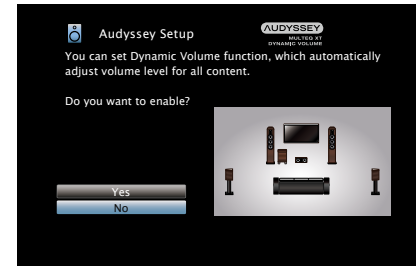

- This feature adjusts the output volume to the optimal level while constantly monitoring the level of the audio input to the unit. Optimal volume control is performed automatically without any loss in the dynamism and clarity of the sound when, for example, the volume suddenly increases for commercials shown during television programs.

NOTE

- After performing Audyssey® Setup, do not change the speaker connections or subwoofer volume. In event of a change, perform Audyssey® Setup again.



Error messages

An error message is displayed if Audyssey® Setup could not be completed due to speaker placement, the measurement environment, etc. If an error message is displayed, check the relevant items and perform the necessary measures. Be sure to turn off the power before checking speaker connections.

Examples	Error details	Measures
Microphone or Speaker is None	<ul style="list-style-type: none"> • Setup and measurement microphone is not detected. • Not all speakers could be detected. 	<ul style="list-style-type: none"> • Connect the included Setup and measurement microphone to the SETUP MIC jack of this unit. • Check the speaker connections.
Ambient noise is too high or level is too low	<ul style="list-style-type: none"> • There is too much noise in the room. • Speaker or subwoofer sound is too low. 	<ul style="list-style-type: none"> • Either turn off any device generating noise or move it away. • Perform again when the surroundings are quieter. • Check the speaker installation and the direction in which the speakers are facing. • Adjust the subwoofer's volume.
Front R : None	<ul style="list-style-type: none"> • The displayed speaker could not be detected. 	<ul style="list-style-type: none"> • Check the connections of the displayed speaker.
Front R : Phase	<ul style="list-style-type: none"> • The displayed speaker is connected with the polarity reversed. 	<ul style="list-style-type: none"> • Check the polarity of the displayed speaker. • For some speakers, this error message may be displayed even if the speaker is properly connected. If you are sure the connection is correct, press ▶ to select "Skip Error", then press ENTER.



Retrieving Audyssey® Setup settings

If you set “Restore...” to “Restore”, you can return to Audyssey® Setup measurement result (value calculated at the start by MultEQ® XT) even when you have changed each setting manually.



Manual Setup

Perform when setting the speakers manually or when changing settings made in Audyssey® Setup.

- If you change the speaker settings after performing Audyssey® Setup, it will not be possible to select Audyssey MultEQ® XT, Audyssey Dynamic EQ® and Audyssey Dynamic Volume® (🔗 [page 128, 129](#)).
- “Manual Setup” can be used without changing the settings. Please set if necessary.

Amp Assign

Select power amplifier usage method to match your speaker system.

■ Assign Mode

Select how to use the power amp.

Surround Back (Default) : Setting for 7.1-channel playback using surround back speakers.

ZONE2 : Setting to assign the unit’s built-in power amplifier for ZONE2 and output the audio in stereo.

Bi-AMP : Setting to use the front speakers via the bi-amp connection.

Front B : Setting to use the second set of front speakers for playback. You can switch the front speakers A and B to be used for playback in accordance with the 2-channel playback or multi-channel playback mode. When you select this Front B setting, also perform the “Front Speaker Setup” (🔗 [page 155](#)) procedure.

Front Height : Setting for 7.1-channel playback using front height speakers.



Speaker Config.

Indicate speaker presence and select speaker size categories based on bass reproduction capability.

■ Front

Set the front speaker size.

Large (Default) : Use a large speaker that can adequately play back very low bass frequencies.

Small : Use a small speaker that has inadequate playback capacity for very low bass frequencies.



- When "Subwoofer" is set to "No", "Front" is automatically set to "Large".
- When "Front" is set to "Small", "Center", "Surround", "Surr. Back" and "Front Height" can not be set to "Large".

■ Center

Set the presence and size of the center speaker.

Large : Use a large speaker that can adequately play back very low bass frequencies.

Small (Default) : Use a small speaker that has inadequate playback capacity for very low bass frequencies.

None : Select when a center speaker is not connected.

■ Subwoofer

Set the presence of a subwoofer.

Yes (Default) : Use a subwoofer.

No : Select when a subwoofer is not connected.

■ Surround

Set the presence and size of the surround speakers.

Large : Use a large speaker that can adequately play back very low bass frequencies.

Small (Default) : Use a small speaker that has inadequate playback capacity for very low bass frequencies.

None : Select when the surround speakers are not connected.



- When "Surround" is set to "None", "Surr. Back" and "Front Height" are automatically set to "None".



■ Surr. Back

Set the presence, size and number of surround back speakers.

Large : Use a large speaker that can adequately play back very low bass frequencies.

Small (Default) : Use a small speaker that has inadequate playback capacity for very low bass frequencies.

None : Select when the surround back speakers are not connected.

2 spkrs (Default) : Use two surround back speakers.

1 spkr : Use only one surround back speaker. When you select this setting, connect the surround back speaker to the left (L) channel.



- When "Assign Mode" ( page 150) setting is "Surround Back", you can make the "Surr. Back" setting.

■ Front Height

Set the presence and size of the front height speakers.

Large : Use a large speaker that can adequately play back very low bass frequencies.

Small (Default) : Use a small speaker that has inadequate playback capacity for very low bass frequencies.

None : Select when the front height speakers are not connected.



- When "Assign Mode" ( page 150) setting is "Front Height", you can make the "Front Height" setting.



Distances

Set distance from listening position to speakers.
Measure beforehand the distance from the listening position to each speaker.

■ Unit

Set the unit of distance.

Meters (Default)

Feet

■ Step

Set the minimum variable width of the distance.

0.1m (Default) / **0.01m**

1ft / **0.1ft**

■ Set Defaults

The “Distances” settings are returned to the default settings.

■ Set the distance

0.00m – 18.00m / 0.0ft – 60.0ft



- The speakers that can be selected differ depending on the “Amp Assign” ([page 150](#)) and “Speaker Config.” ([page 151](#)) settings.
- Default settings :
Front L / Front R / F. Height L / F. Height R / Center / Subwoofer : 3.60 m (12.0 ft)
Surround L / Surround R / Surr. Back L / Surr. Back R : 3.00 m (10.0 ft)
- Set the difference in the distance between the speakers to less than 6.00 m (20.0 ft).

Levels

Set the volume of the test tone to be the same when it is output from each speaker.

■ Test Tone Start

Output test tone. A test tone is output from the selected speaker. While listening to the test tone, adjust the volume output from the selected speaker.

-12.0dB – +12.0dB (Default : 0.0dB)



- When “Levels” is adjusted, the adjusted values are set for all the sound modes.
- When headphones are connected to the PHONES connector on this unit, you cannot set “Levels”.

■ Set Defaults

The “Levels” settings are returned to the default settings.



Crossovers

Set in accordance with the lower limit frequency of the base frequencies that can be played back through each speaker.

■ Speaker Selection

Selects how to set the crossover frequency. See the speaker manual for information concerning speaker crossover frequency.

All (Default) : Sets the same crossover frequency for all speakers.

Individual : Selects the crossover points for each speaker individually.

■ Set the crossover frequency

40Hz / 60Hz / 80Hz (Default) / **90Hz / 100Hz / 110Hz / 120Hz / 150Hz / 200Hz / 250Hz**



- “Crossovers” can be set when the “Subwoofer Mode” ([page 155](#)) setting is “LFE+Main”, or when you have a speaker that is set to “Small”.
- The default crossover frequency is “80Hz”, which will work best with the widest variety of speakers. We recommend setting to a higher frequency that the crossover frequency when small speakers are used. For example, set to “250Hz” when the frequency range of the speakers is 250 Hz – 20 kHz.
- For speakers set to “Small”, low frequency content below the crossover frequency is attenuated to the speakers and the low bass content is then re-delivered to the subwoofer, or the front (L/R) speakers if they have been set to Large.
- The speakers that can be set when “Individual” is selected differ depending on to the “Subwoofer Mode” ([page 155](#)) setting.
 - When “LFE” is selected, speakers set to “Small” at “Speaker Config.” ([page 151](#)) can be set. If the speakers are set to “Large”, “Full Band” is displayed and the setting cannot be made.
 - When “LFE+Main” is selected, speakers can be set regardless of the “Speaker Config.” ([page 151](#)) setting.



Bass

Set subwoofer and LFE signal range playback.

■ Subwoofer Mode

Select low range signals to be reproduced by subwoofer.

LFE (Default) : The low range signal of the channel set to "Small" speaker size is added to the LFE signal output from the subwoofer.

LFE+Main : The low range signal of all channels is added to the LFE signal output from the subwoofer. This is usually the best setting for most systems.



- "Subwoofer Mode" can be set when "Speaker Config." – "Subwoofer" ([page 151](#)) is set to other than "No".
- Play music or a movie source and select the mode offering the strongest bass.
- If "Front" and "Center" for "Speaker Config." ([page 151](#)) are set to "Large", and "Subwoofer Mode" is set to "LFE", no sound may be output from the subwoofers, depending on the input signal or selected sound mode. Select "LFE+Main" if you want the bass signals to always be produced from the subwoofer.

■ LPF for LFE

Set LFE signal playback range. Set this when you want to change the playback frequency (low pass filter point) of the subwoofer.

80Hz / 90Hz / 100Hz / 110Hz / 120Hz (Default) / **150Hz / 200Hz / 250Hz**

Front Speaker Setup

Set the front speaker A/B to use for every sound mode.



- This can be set when "Assign Mode" ([page 150](#)) is set to "Front B".

■ 2ch Playback

The front speakers used in direct play (2-channel), stereo play and pure direct play (2-channel) are set in advance.

A (Default) : Front speaker A is used.

B : Front speaker B is used.

A+B : Both front speakers A and B are used.

■ Multi ch Playback

The front speakers used in play modes other than direct play (2-channel), stereo play and pure direct play (2-channel) are set in advance.

A (Default) : Front speaker A is used.

B : Front speaker B is used.

A+B : Both front speakers A and B are used.



Network

To use this unit by connecting it to a home network (LAN), you must configure network settings.

If you set up your home network (LAN) via DHCP, set “DHCP” to “On” (use the default setting). This allows this unit to use your home network (LAN). When assigning an IP address to each device manually, you need to assign an IP address to this unit using the “IP Address” settings, and enter information about your home network (LAN) such as the gateway address and subnet mask, etc.

Information

Display network information.

Friendly Name / DHCP On or Off / IP Address / MAC Address



- MAC Address is required to make a vTuner account.

IP Control

Enables network communication in standby power mode.

Off In Standby (Default) : Suspend network function during standby.

Always On : Network is on during standby. Main unit operable with a network compatible controller.



- When using the web control function or Denon Remote App, use with the “IP Control” setting set to “Always On”.

NOTE

- When “IP Control” is set to “Always On”, it consumes more standby power.

Friendly Name

The Friendly Name is the name of this unit displayed on the network. You can change the Friendly Name according to your preferences.

■ Edit Name

Edits Friendly Name.



- The default Friendly Name on first use is “Denon AVR-X2000”.
- Up to 63 characters can be input.
- For character input, see [page 121](#).

■ Set Defaults

Restores Friendly Name, which you had changed, to the default setting.



Settings

Make settings for wired LAN.

- If you are using a broadband router (DHCP function), there is no need to make the settings at “IP Address” and “Proxy”, since the DHCP function is set to “On” in this unit’s default settings.
- Only set “Settings” when connecting to a network without a DHCP function.

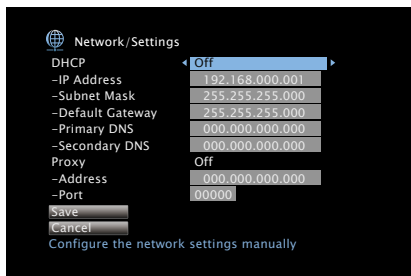

■ DHCP

Selects how to connect to the network.

On (Default) : Configure the network settings automatically from your router.

Off : Configure the network settings manually.

■ IP Address

Set the IP address within the ranges shown below.

- The Network Audio function cannot be used if other IP addresses are set.

CLASS A: 10.0.0.1 – 10.255.255.254

CLASS B: 172.16.0.1 – 172.31.255.254

CLASS C: 192.168.0.1 – 192.168.255.254

■ Subnet Mask

When connecting an xDSL modem or connector adapter directly to this unit, input the subnet mask indicated in the documentation supplied by your provider. Normally input 255.255.255.0.

■ Default Gateway

When connected to a gateway (router), input its IP address.

■ Primary DNS, Secondary DNS

If there is only one DNS address indicated in the documentation supplied by your provider, input it at “Primary DNS”. If two or more DNS are provided by your provider, enter both “Primary DNS” and “Secondary DNS”.



■ Proxy

Make this setting when connecting to the Internet via a proxy server. Make the proxy settings only when you connect to the Internet via a proxy server that is on your internal network or provided by your provider, etc.

On(Address) : Select when inputting by address.

On(Name) : Select when inputting by domain name. Up to 38 characters can be input.

Off (Default) : Disables the proxy server.

■ Port

Enter port number.



- If you cannot connect to the Internet, recheck the connections and settings ( page 39).
- If you do not understand about Internet connection, contact your ISP (Internet Service Provider) or the store from which you purchased your computer.

Diagnostics

Used to check the network connection.

■ Physical Connection

Checks the physical LAN port connection.

OK

Error : The LAN cable is not connected. Check the connection.

■ Router Access

Checks the connection from this unit to the router.

OK

Error : Failed to communicate with the router. Check the router settings.

■ Internet Access

Checks whether this unit has access to the Internet (WAN).

OK

Error : Failed to connect to the Internet. Check the Internet connection environment or router settings.



Maintenance Mode

Use when receiving maintenance from a Denon service engineer or custom installer. Ordinarily, this mode isn't suitable for use by the end user, only by a trained service technician or custom installation professional.

NOTE

- Only use this function if so instructed by a Denon serviceperson or installer.



General

Make various other settings.

Language

Set the language for display the menu on the TV screen.

English (Default) / **Deutsch** / **Français** / **Italiano** / **Español** / **Nederlands** / **Svenska** / **Русский** / **Polski**



- “Language” can also be set by the following procedure. However, the menu screen is not displayed.

Following the display content to make the setting.

1. Press and hold the main unit’s ZONE2 SOURCE and STATUS for at least 3 seconds.
“V.Format:<PAL>” appears on the display.
2. Press the main unit’s DIMMER.
“Lang.:<ENGLISH >” appears on the display.
3. Use the main unit’s TUNER PRESET CH +, – and set the language.
4. Press the main unit’s STATUS to complete the setting.

ZONE2 Setup

Set the audio to play back with multi-zone (ZONE2).



- Values set for “Volume Limit” and “Power On Volume” are displayed according to the setting specified for the volume “Scale” ( [page 127](#)).

■ Lch Level

Adjust the left channel output level.

-12dB – +12dB (Default : 0dB)

■ Rch Level

Adjust the right channel output level.

-12dB – +12dB (Default : 0dB)

■ Volume Level

Set the volume output level.

Variable (Default) : Volume adjustment is enabled by main unit and remote control unit.

1 – 98 (-79dB – 18dB) : The volume is adjusted to the set level.



■ Volume Limit

Make a setting for maximum volume.

60 (-20dB) / 70 (-10dB) / 80 (0dB) (Default : 70 (-10dB))

Off : Do not set a maximum volume.



- This can be set when “Volume Level” ( [page 160](#)) is set to “Variable”.

■ Power On Volume

Define the volume setting that is active when the power is turned on.

Last (Default) : Use the memorized setting from the last session.

Mute : Always mute when power is turned on.

1 – 98 (-79dB – 18dB) : The volume is adjusted to the set level.



- This can be set when “Volume Level” ( [page 160](#)) is set to “Variable”.

■ Mute Level

Set the amount of attenuation when muting is on.

Full (Default) : The sound is muted entirely.

-40dB : The sound is attenuated by 40 dB down.

-20dB : The sound is attenuated by 20 dB down.



- This can be set when “Volume Level” ( [page 160](#)) is set to “Variable”.

Zone Rename

Change the display title of each zone to one you prefer.

MAIN ZONE / ZONE2

Set Defaults : The input source name is returned to the default setting.



- Up to 10 characters can be input.
- For character input, see [page 121](#).

Quick Select Names

Change the “Quick Select” display title to one you prefer.

Quick Select 1 / Quick Select 2 / Quick Select 3 / Quick Select 4

Set Defaults : The input source name is returned to the default setting.



- Up to 16 characters can be input.
- For character input, see [page 121](#).



Auto Standby

Sets the time after which the unit automatically enters standby mode when there are no audio or video signals input, and the unit is not operated. Before it enters the standby mode, "Auto Standby" is displayed on the display of this unit and the menu screen.

60 min : The unit goes into standby after 60 minutes.

30 min (Default) : The unit goes into standby after 30 minutes.

Off : The unit does not go into standby automatically.

Front Display

Makes settings related to the display on this unit.

■ Dimmer

Adjust the display brightness of this unit.

Bright (Default) : Normal display brightness.

Dim : Reduced display brightness.

Dark : Very low display brightness.

Off : Turns the display off.



- You can also adjust the display by turning DIMMER on the main unit.

Information

Show information about receiver settings, input signals, etc.

■ Audio

Show the audio information for MAIN ZONE.

Sound Mode : The currently set sound mode.

Input Signal : The input signal type.

Format : The number of input signal channels (presence of front, surround, LFE).

Sample Rate : The input signal's sampling frequency.

Offset : The dialogue normalization correction value.

Flag : This is displayed when inputting signals including a surround back channel. "MATRIX" is displayed with Dolby Digital EX and DTS-ES Matrix signals, "DISCRETE" with DTS-ES Discrete signals.

Dialogue normalization function

This function is automatically activated when playing Dolby Digital, Dolby Digital Plus, Dolby TrueHD, DTS and DTS-HD sources. It automatically corrects the standard signal level for individual program sources.

The correction value can be checked using the STATUS on the main unit.

Offset: - 4dB

The figure is the corrected value. This cannot be changed.



Video

Show the HDMI input/output signals and HDMI monitor information for MAIN ZONE.

HDMI Signal Info.

Resolution / Color Space / Pixel Depth

HDMI Monitor

Interface / Resolutions

ZONE

Show information about current settings.

MAIN ZONE : This item shows information about settings for MAIN ZONE. The information displayed differs according to the input source.

ZONE2 : This item shows information about settings for ZONE2.

Firmware

Version : Displays information for the current firmware.

Notifications

Displays and sets notifications from Denon.

Also, sets whether or not to display the notification when the power is turned on.

Notification Alerts

On (Default) : Displays notification messages from Denon.

Off : Does not display notification messages from Denon.



- Press INFO on the remote control unit to display current source name, volume, sound mode name, and other information at the bottom of the screen.

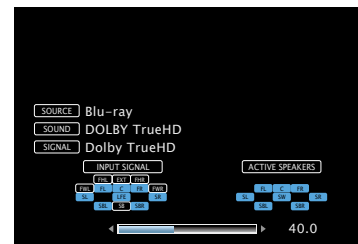

NOTE

- The status display screen cannot be displayed at a computer's resolution (e.g. VGA) is being played.



Usage Data

To help us improve our products and customer service, Denon collects anonymous information about how you use your AV receiver (such as frequently used input sources and sound modes and speaker settings). Denon will never provide any information we collect to third parties.

Yes : Provide Denon with information about how you use this unit via the network.

No : Do not provide Denon with information about how you use this unit via the network.

Firmware

Checks for the latest firmware information about updates and upgrades, updates the firmware, and sets up the notification message display for updates and upgrades.

■ Update

Update the firmware of the receiver.

Check for Update : Check for firmware updates. You can also check approximately how long it will take to complete an update.

Update Start : Execute the update process. When the update starts, the menu screen is shut down. During the update, the progress is shown on the display.



- If updating fails, the set automatically retries, but if updating is still not possible, one of the messages shown below is displayed. If the display reads as shown below, check the settings and network environment, then update again.

Display	Description
Updating fail	Updating failed.
Login failed	Failure to log into server.
Server is busy	Server is busy. Wait a while then try again.
Connection fail	Failure in connecting to server.
Download fail	Downloading of the firmware has failed.



■ Notifications

When the latest firmware is available, a notification message is displayed on the TV screen at power on.

The notification message is displayed for about 20 seconds when the power is turned on. Connect to broadband Internet ( page 39) when using this function.

Update

On (Default) : Display update message.

Off : Do not display update message.

Upgrade

On (Default) : Display upgrade message.

Off : Do not display upgrade message.

■ Add New Feature

Display new features that can be downloaded to this unit and perform an upgrade.

Upgrade Package : Display the items to be upgraded.

Upgrade Status : Display a list of the additional functions provided by the upgrade.

Upgrade Start : Execute the upgrade process. When the upgrade starts, the menu screen is shut down. During the upgrade, the amount of upgrade time which has elapsed is displayed.



- See the Denon website for details about upgrades.
- When the procedure is complete, "Registered" is displayed in this menu and upgrades can be carried out. If the procedure has not been carried out, "Not Registered" is displayed.
The ID number shown on this screen is needed when carrying out the procedure.
The ID number can also be displayed by pressing and holding the main unit's TUNER PRESET CH – and STATUS for at least 3 seconds.
- If the upgrade is not successful, an error message identical to those in "Update" will appear on the display. Check the settings and network environment and then perform the upgrade again.



Notes concerning use of "Update" and "Add New Feature"

- In order to use these functions, you must have the correct system requirements and settings for a broadband Internet connection (☞ page 39).
- Do not turn off the power until updating or upgrading is completed.
- Even with a broadband connection to the Internet, approximately 1 hour is required for the updating/upgrading procedure to be completed.
- Once updating/upgrade starts, normal operations on this unit cannot be performed until updating/upgrading is completed. Furthermore, there may be cases where backup data is reset for the parameters, etc., set on this unit.
- If the update or upgrade fails, press and hold the  on the main unit for more than 5 seconds, or remove and re-insert the power cord. "Update retry" appears on the display and update restarts from the point at which update failed. If the error continues despite this, check the network environment.



- Information regarding the "Update" function and "Add New Feature" will be announced on the Denon web site each time related plans are defined.

Setup Lock

Protect settings from inadvertent changes.

■ Lock

On : Turn protection on.

Off (Default) : Turn protection off.



- When cancelling the setting, set "Lock" to "Off".

NOTE

- When "Lock" is set to "On", no setting items are displayed except for "Setup Lock".



Specifying the zone used with the remote control unit

When the ZONE2 button is pressed, only the MAIN ZONE can be operated with the remote control unit.

- 1 Press and hold ZONE2 and SETUP.**
MAIN and ZONE2 button blink.

■ To cancel

- 1 Press and hold ZONE2 and SETUP.**
MAIN and ZONE2 button blink.



Tips

Contents

■ Tips	(169)	■ Troubleshooting	(171)
I want the volume not to become too loud by mistake.....	(169)	Power does not turn on/Power is turned off	(171)
I want to keep the volume at the same level when I turn the power on	(169)	Operations cannot be performed through the remote control unit.....	(172)
I want to have the subwoofer always output audio	(169)	Display on this unit shows nothing	(172)
I want to make human voices in the movies clearer	(169)	No sound comes out	(173)
I want to keep bass and clarity during playback at a lower volume level	(169)	Desired sound does not come out	(174)
I want to automatically adjust the volume level difference in content such as TV and movies	(169)	Sound is interrupted or noise occurs.....	(176)
I want to set the optimized listening environment after changing the configuration/position of the speakers or changing a speaker to a new one	(169)	No video is shown on the TV	(176)
I want to combine a desired video with the current music	(170)	The menu screen is not displayed on the TV	(177)
I want to play back photos from Flickr at the same time while listening to the Internet radio	(170)	iPod cannot be played back.....	(178)
I want to delete unused input sources	(170)	USB memory devices cannot be played back	(179)
I want to enjoy the same music in all zones at the home party, etc.	(170)	File names on the iPod/USB memory device are not displayed properly	(180)
I want to minimize the delay in video signals when I'm playing a game on my game console	(170)	The Internet radio cannot be played back	(180)
How to add Wi-Fi to the AV receiver?	(170)	Music files on PC or NAS cannot be played back.....	(181)
		The HDMI control function does not work	(182)
		When using ZONE2, no sound comes out.....	(182)



Tips

I want the volume not to become too loud by mistake.

- Set the volume upper limit for “Volume Limit” in the menu beforehand. This prevents children or others from increasing the volume too much by mistake. You can set this for each zone ( [page 127, 161](#)).

I want to keep the volume at the same level when I turn the power on.

- By default, the volume setting when power was previously set to standby is applied at next power on. To use a fixed volume level, set the volume level at power on for “Volume Limit” in the menu. You can set this for each zone ( [page 127, 161](#)).

I want to have the subwoofer always output audio.

- Depending on the input signals and sound mode, the subwoofer may not output audio. When “Subwoofer Mode” in the menu is set to “LFE+Main”, you can have the subwoofer always output audio ( [page 155](#)).

I want to make human voices in the movies clearer.

- Use “Dialog Level” in the menu to adjust the level ( [page 122](#)).

I want to keep bass and clarity during playback at a lower volume level.

- Set “Dynamic EQ” in the menu to “On”. This setting corrects the frequency characteristics to allow you to enjoy clear sound without the bass being lost even during playback at a lower volume level ( [page 128](#)).

I want to automatically adjust the volume level difference in content such as TV and movies.

- Set “Dynamic Volume” in the menu. Volume level changes (between quiet scenes and loud scenes) in TV shows or movies are automatically adjusted to your desired level ( [page 129](#)).

I want to set the optimized listening environment after changing the configuration/position of the speakers or changing a speaker to a new one.

- Perform Audyssey® Setup. This automatically makes the optimized speaker settings for the new listening environment ( [page 141](#)).



I want to combine a desired video with the current music.

- Set “Video Select” in the option menu to “On”. You can combine the current music with your desired video source from Set-top Box or DVD, etc. while listening to music from Tuner, CD or the Internet radio (🔧 [page 91](#)).

I want to play back photos from Flickr at the same time while listening to the Internet radio.

- After playing back photos from Flickr, start the slide show on the Internet radio playback screen (🔧 [page 90](#)).

I want to delete unused input sources.

- Set unused input sources for “Hide Sources” in the menu. This allows you to skip unused input sources when rotating the SOURCE SELECT knob on this unit (🔧 [page 139](#)).

I want to enjoy the same music in all zones at the home party, etc.

- Set “All Zone Stereo” in the option menu to “On”. This allows you to simultaneously play back in ZONE2 the music that is played back in MAIN ZONE (🔧 [page 93](#)).

I want to minimize the delay in video signals when I’m playing a game on my game console.

- When the video is delayed against button operations with the controller on the game console, set “Video Mode” in the menu to “Game” (🔧 [page 134](#)).

How to add Wi-Fi to the AV receiver?

- Connect a wireless LAN converter (sold separately) to the NETWORK connector on this unit.



Troubleshooting

If a problem should arise, first check the following:

1. Are the connections correct?
2. Is the set being operated as described in the owner's manual?
3. Are the other devices operating properly?

If this unit does not operate properly, check the items listed in the table below. Should the problem persist, there may be a malfunction. In this case, disconnect the power immediately and contact your store of purchase.

■ Power does not turn on / Power is turned off

Symptom	Cause / Solution	Page
Power does not turn on.	<ul style="list-style-type: none"> • Check whether the power plug is correctly inserted into the power outlet. 	<u>40</u>
Power automatically turns off.	<ul style="list-style-type: none"> • The sleep timer is set. Turn on the power again. • "Auto Standby" is set. "Auto Standby" is triggered when there is no operation for a set amount of time. To disable "Auto Standby", set "Auto Standby" on the menu to "Off". 	<u>106</u> <u>162</u>
Power turns off and the power indicator flashes in red approx. every 2 seconds.	<ul style="list-style-type: none"> • The protection circuit has been activated due to a rise in temperature within this unit. Turn the power off, wait about an hour until this unit cools down sufficiently, and then turn the power on again. • Please re-install this unit in a place having good ventilation. 	<u>203</u> –
Power turns off and the power indicator flashes in red approx. every 0.5 seconds.	<ul style="list-style-type: none"> • Check the speaker connection. The protection circuit may have been activated because speaker cable core wires came in contact with each other or a core wire was disconnected from the connector and came in contact with the rear panel of this unit. After unplugging the power cord, take corrective action such as firmly re-twisting the core wire or taking care of the connector, and then reconnect the wire. • Turn down the volume and turn on the power again. • This unit's amplifier circuit has failed. Unplug the power cord and contact our customer service center. 	<u>23</u> <u>42, 43</u> –
Power does not turn off even when the power button is pressed, and the display shows "Main Zone Off".	<ul style="list-style-type: none"> • Power in either ZONE2 is on. To turn the power of the unit off (standby), either press the ZONE2 ON/OFF button on the unit, or press the ZONE2 button on the remote control and then press the POWER  button to turn the ZONE2 power off. 	–



■ Operations cannot be performed through the remote control unit

Symptom	Cause / Solution	Page
Operations cannot be performed through the remote control unit.	• Batteries are worn out. Replace with new batteries.	7
	• Operate the remote control unit within a distance of about 7 m from this unit and at an angle of within 30°.	7
	• Remove any obstacle between this unit and the remote control unit.	–
	• Insert the batteries in the proper direction, checking the ⊕ and ⊖ marks.	7
	• The set's remote control sensor is exposed to strong light (direct sunlight, inverter type fluorescent bulb light, etc.). Move the set to a place in which the remote control sensor will not be exposed to strong light.	–
	• The operation target zone does not correspond to the zone setting specified on the remote control unit. Press MAIN or ZONE2 to select the zone to operate.	112 , 120
	• When using a 3D video device, the remote control unit of this unit may not function due to effects of infrared communications between units (such as TV and glasses for 3D viewing). In this case, adjust the direction of units with the 3D communications function and their distance to ensure they do not affect operations from the remote control unit of this unit.	–

■ Display on this unit shows nothing

Symptom	Cause / Solution	Page
Display is off.	<ul style="list-style-type: none"> • Set "Dimmer" on the menu to something other than "Off". • When the sound mode is set to PURE DIRECT, the display is off. 	162 96



■ No sound comes out

Symptom	Cause / Solution	Page
No sound comes out of speakers.	<ul style="list-style-type: none"> • Check the connections for all devices. • Insert connection cables all the way in. • Check that input connectors and output connectors are not reversely connected. • Check cables for damage. • Check that speaker cables are properly connected. Check that cable core wires come in contact with the metal part on speaker terminals. Also, securely tighten speaker terminals. Check speaker terminals for looseness. • Check that a proper input source is selected. • Adjust the master volume. • Cancel the mute mode. • Check the digital audio input connector setting. • Check the digital audio output setting on the connected device. On some devices, the digital audio output is set to off by default. • No sound is output from the speakers when headphones are connected. 	23 , 30 , 31 , 33 , 34 , 35 , 36 , 38 , 39 – – – 23 42 , 112 43 , 112 43 , 113 138 – 11
No sound comes out when using the DVI-D connection.	<ul style="list-style-type: none"> • When this unit is connected to a device equipped with a DVI-D connector, no sound is output. Make a separate audio connection. 	–



■ Desired sound does not come out

Symptom	Cause / Solution	Page
The volume does not increase.	<ul style="list-style-type: none"> • The maximum volume is set too low. Set the maximum volume using "Limit" on the menu. • Appropriate volume correction processing is performed according to the input audio format and settings, so the volume may not reach the upper limit. 	127 , 161 -
No sound comes out with the HDMI connection.	<ul style="list-style-type: none"> • Check the connection of the HDMI connectors. • When outputting HDMI audio from the speakers, set "HDMI Audio Out" on the menu to "AVR". To output from the TV, set "TV". • When using the HDMI control function, check that the audio output is set to the AV amplifier on the TV. 	30 , 31 , 33 , 34 , 35 132 105
No sound comes out of a specific speaker.	<ul style="list-style-type: none"> • Check that the speaker cable is properly connected. • Check that a selection other than "None" is set for the "Speaker Config." setting in menu. • Check the "Assign Mode" setting in the menu. • When the sound mode is "STEREO" and "VIRTUAL", audio is only output from the front speakers and subwoofer. 	23 151 , 152 150 -
No sound is produced from subwoofer.	<ul style="list-style-type: none"> • Check the subwoofer connections. • Turn on the subwoofer's power. • Set "Speaker Config." - "Subwoofer" on the menu to "Yes". • When "Speaker Config." - "Front" in the menu is set to "Large", depending on the input signal and the sound mode, no sound may be output from the subwoofer. • When no subwoofer audio signal (LFE) is included in the input signals, no sound may be output from the subwoofer. • You can make the subwoofer always output sound by setting the subwoofer mode to "LFE+Main". 	24 - 151 151 155 155



Symptom	Cause / Solution	Page
DTS sound is not output.	<ul style="list-style-type: none"> • Check that the digital audio output setting on the connected device is set to "DTS". • Set "Decode Mode" on the menu to "Auto" or "DTS". 	– <u>140</u>
Dolby TrueHD, DTS-HD, Dolby Digital Plus audio is not output.	<ul style="list-style-type: none"> • Make HDMI connections. • Check the digital audio output setting on the connected device. On some devices, "PCM" is set by default. 	<u>33, 34, 35</u> –
Dolby PLII mode or DTS NEO:6 mode cannot be selected.	<ul style="list-style-type: none"> • It cannot be selected when "None" is set for "Speaker Config." – "Center" and "Surround". • These cannot be selected when using the headphones. 	<u>151</u> –
Audyssey MultEQ® XT, Audyssey Dynamic EQ® and Audyssey Dynamic Volume® cannot be selected.	<ul style="list-style-type: none"> • These cannot be selected when you have not performed Audyssey® Setup. • Switch the sound mode to other than "DIRECT" or "PURE DIRECT". • These cannot be selected when using the headphones. 	<u>141</u> <u>96</u> –
"Restorer" cannot be selected.	<ul style="list-style-type: none"> • Check that an analog signal or PCM signal (Sample Rate=44.1/48 kHz) is input. For playback of multichannel signals such as Dolby Digital or DTS surround, "Restorer" cannot be used. • Switch the sound mode to other than "DIRECT" or "PURE DIRECT". 	<u>126</u> <u>96</u>
No audio is output in ZONE2.	<ul style="list-style-type: none"> • You cannot play back the audio for digital signals that are input from the HDMI connector or digital connectors (OPTICAL/COAXIAL). Make an analog connection instead. 	–



■ Sound is interrupted or noise occurs

Symptom	Cause / Solution	Page
During playback from the Internet radio or USB memory device, sound is occasionally interrupted.	<ul style="list-style-type: none"> When the transfer speed of the USB memory device is slow, sound may occasionally be interrupted. The network communication speed is slow or the radio station is busy. 	–
When making a call on iPhone, noise occurs in audio output on this unit.	<ul style="list-style-type: none"> When making a call, keep a distance of 20 cm or longer between iPhone and this unit. 	–
Noise often occurs in FM broadcasting.	<ul style="list-style-type: none"> Change the antenna orientation or position. Use an FM outdoor antenna. Separate the antenna from other connection cables. 	38 38 38

■ No video is shown on the TV

Symptom	Cause / Solution	Page
No picture appears.	<ul style="list-style-type: none"> Check the connections for all devices. Insert connection cables all the way in. Check that input connectors and output connectors are not reversely connected. Check cables for damage. Match the input settings to the input connector of the TV connected to this unit. Check that the proper input source is selected. Check the video input connector setting. Check that the resolution of the player corresponds to that of the TV. Check whether the TV is compatible with copyright protection (HDCP). If connected to a device not compatible with HDCP, video will not be output correctly. The HDMI signal cannot be converted to an analog signal. Use analog connections. 	30 , 31 , 33 , 34 , 35 , 36 , 38 , 39 – – – 137 42 , 112 137 163 186 187





Symptom	Cause / Solution	Page
No video is shown on the TV with the DVI-D connection.	<ul style="list-style-type: none"> With the DVI-D connection, on some device combinations, devices may not function properly due to the copy guard copyright protection (HDCP). 	186
No video from an input source such as a game console is shown on the TV.	<ul style="list-style-type: none"> When special video signals are input from a game console, etc., the video conversion function may not function. Connect the input connector to the monitor output connector of the same type. 	–
While the menu is being displayed, no video is shown on the TV.	<ul style="list-style-type: none"> When the menu is operated during playback of some 3D video contents or of video at some computer resolutions (such as VGA), no playback video is shown in the background of the menu. 	–

■ The menu screen is not displayed on the TV

Symptom	Cause / Solution	Page
The menu screen or status information screen is not displayed on the TV.	<ul style="list-style-type: none"> The menu screen is only displayed on this unit and a TV connected by HDMI cable. If this unit is connected to a TV using a different video output connector, operate while watching the display on this unit. 	–
	<ul style="list-style-type: none"> No status information is displayed for some 3D videos or videos with a computer resolution such as VGA. 	163
	<ul style="list-style-type: none"> When a 2D video is converted to a 3D video on the TV, the menu screen or status information screen is not properly displayed. 	–
	<ul style="list-style-type: none"> In the pure direct playback mode, the menu screen or status information is not displayed. Switch to a sound mode other than the pure direct mode. 	95 , 96
	<ul style="list-style-type: none"> Set the “TV Format” setting in the menu to a selection that is appropriate for the TV. 	136



■ iPod cannot be played back

Symptom	Cause / Solution	Page
iPod cannot be connected.	<ul style="list-style-type: none"> When using iPod by connecting it to the USB port, some iPod variations are not supported. When iPod is connected by using a USB cable other than the genuine cable, iPod may not be recognized. Use a genuine USB cable. 	37 –
The AirPlay icon  is not displayed on iTunes / iPhone / iPod touch / iPad.	<ul style="list-style-type: none"> This unit and PC / iPhone / iPod touch / iPad are not connected to the same network (LAN). Connect it to the same LAN as this unit. The firmware on iTunes / iPhone / iPod touch / iPad is not compatible with AirPlay. Update the firmware to the latest version. 	39 –
Audio is not output.	<ul style="list-style-type: none"> The volume on iTunes / iPhone / iPod touch / iPad is set to the minimum level. The volume on iTunes / iPhone / iPod touch / iPad is linked with the volume on this unit. Set a proper volume level. The AirPlay playback is not performed, or this unit is not selected. Click the AirPlay icon  on the iTunes / iPhone / iPod touch / iPad screen and select this unit. 	– 83
Audio is interrupted during the AirPlay playback on iPhone / iPod touch / iPad.	<ul style="list-style-type: none"> Quit the application running in the background of the iPhone/iPod touch/iPad, and then play using AirPlay. Some external factors may be affecting the wireless connection. Modify the network environment by taking measures such as shortening the distance from the wireless LAN access point. 	– –
iTunes cannot be played back through the remote control unit.	<ul style="list-style-type: none"> Enable the “Allow iTunes audio control from remote speakers” setting on iTunes. Then, you can perform playback, pause, and skip operations through the remote control unit. 	–



■ USB memory devices cannot be played back

Symptom	Cause / Solution	Page
"No Connection" is displayed.	<ul style="list-style-type: none"> This unit may not recognize the USB memory device due to poor connection, etc. Make sure that the connection is made properly by taking actions such as disconnecting and reconnecting the USB memory device. USB memory devices of a mass storage class or those compatible with MTP are supported. This unit does not support a connection through a USB hub. Connect the USB memory device directly to the USB port. The USB memory device must be formatted to FAT16 or FAT32. Not all USB memory devices are guaranteed to work. Some USB memory devices are not recognized. When using a type of portable hard disc drive compatible with the USB connection that requires power from an AC adapter, use the AC adapter that came with the drive. 	<p><u>36</u></p> <p>–</p> <p>–</p> <p>–</p> <p>–</p>
Files on the USB memory device are not displayed.	<ul style="list-style-type: none"> Files of a type not supported by this unit are not displayed. This unit can display a file structure with up to 8 levels and up to 5000 subfolders and files in total. Modify the folder structure of the USB memory device. When multiple partitions exist on the USB memory device, only files on the first partition are displayed. 	<p><u>48</u></p> <p>–</p> <p>–</p>
Files on a USB memory device cannot be played.	<ul style="list-style-type: none"> Files are created in a format that is not supported by this unit. Check the formats supported by this unit. You are attempting to play a file that is copyright protected. Files that are copyright protected cannot be played on this unit. 	<p><u>189</u></p> <p>–</p>



■ File names on the iPod/USB memory device are not displayed properly

Symptom	Cause / Solution	Page
The file names are not displayed properly ("...", etc.).	<ul style="list-style-type: none"> Characters that cannot be displayed are used. This is not a malfunction. On this unit, characters that cannot be displayed are replaced with a "." (period). 	–

■ The Internet radio cannot be played back

Symptom	Cause / Solution	Page
A list of broadcasting stations is not displayed.	<ul style="list-style-type: none"> The LAN cable is not properly connected, or the network is disconnected. Check the connection status. Perform the network diagnostic mode. 	39 –
Internet Radio cannot be played.	<ul style="list-style-type: none"> The selected radio station is broadcasting in a format that is not supported by this unit. Formats that can be played back in this unit are MP3, WMA and AAC. The firewall function is enabled on the router. Check the firewall setting. The IP address is not properly set. Check the power of the router is on. To obtain the IP address automatically, enable the DHCP server function on the router. Also, set the DHCP setting to "On" on this unit. To obtain the IP address manually, set the IP address and proxy on this unit. Some radio stations broadcast silently during some time period. In this case, no audio is output. Wait for a while and select the same radio station, or select another radio station. 	191 – 157 – 157 157, 158 61
Cannot connect to favorite radio stations.	<ul style="list-style-type: none"> Radio station is not currently in service. Register radio stations in service. 	–
For some radio stations, "Connection down" is displayed and station cannot be connected to.	<ul style="list-style-type: none"> The selected radio station is not in service. Select a radio station in service. 	–



■ Music files on PC or NAS cannot be played back

Symptom	Cause / Solution	Page
Files stored on a computer cannot be played.	<ul style="list-style-type: none"> Files are stored in a non-compatible format. Record in a compatible format. You are attempting to play a file that is copyright protected. Files that are copyright protected cannot be played on this unit. Set and computer are connected by USB cable. The set's USB port cannot be used for connection to a computer. Media sharing settings are not correct. Change media sharing settings so that the unit can access the folders on your computer. 	<p>190</p> <p>–</p> <p>–</p> <p>65</p>
Server is not found, or it is not possible to connect to the server.	<ul style="list-style-type: none"> The computer's or router's firewall is activated. Check the computer's or router's firewall settings. Computer's power is not turned on. Turn on the power. Server is not running. Launch the server. Set's IP address is wrong. Check the set's IP address. 	<p>–</p> <p>–</p> <p>–</p> <p>156</p>
Music files on PC cannot be played back.	<ul style="list-style-type: none"> Even if PC is connected to the USB connector on this unit, music files on it cannot be played back. Connect PC or NAS to this unit through the network. 	<p>39</p>
Files on PC or NAS are not displayed.	<ul style="list-style-type: none"> Files of a type not supported by this unit are not displayed. 	<p>190</p>
Music stored on a NAS cannot be played.	<ul style="list-style-type: none"> If you use a NAS in conformity with the DLNA standard, enable the DLNA server function in the NAS setting. If you use a NAS that does not conform with the DLNA standard, play the music via a PC. Set Windows Media Player's media sharing function and add NAS to the selected play folder. If connection is restricted, set audio equipment as the connection target. 	<p>–</p> <p>65</p> <p>–</p>



■ The HDMI control function does not work

Symptom	Cause / Solution	Page
The HDMI control function does not work.	<ul style="list-style-type: none"> • Check that "HDMI Control" in the menu is set to "On". • You cannot operate devices that are not compatible with the HDMI control function. In addition, depending on the connected device or the settings, the HDMI control function may not work. In this case, operate the external device directly. • Check that the HDMI control function setting is enabled on all devices connected to this unit. • When you make connection related changes such as connecting an additional HDMI device, the link operation settings may be initialized. Turn off this unit and devices connected via HDMI, and turn them on again. 	133 105 105 105

■ When using ZONE2, no sound comes out



Symptom	Cause / Solution	Page
When using ZONE2, no sound comes out.	<ul style="list-style-type: none"> • In ZONE2, you can select iPod/USB, TUNER, NETWORK or an input source with an analog audio input connector. 	112

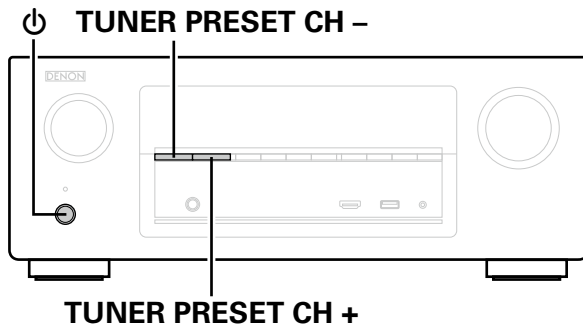

Resetting factory settings

Perform this procedure if the display is abnormal or if operations cannot be performed. Various settings are reset to the factory default values. Make settings again.



- 1** Turn off the power using .
- 2** Press  while simultaneously pressing TUNER PRESET CH - and TUNER PRESET CH +.
- 3** Once the display starts flashing at intervals of about 1 second, release the two buttons.



- If in step 3 the display does not flash at intervals of about 1 second, start over from step 1.



Appendix

About HDMI

HDMI is an abbreviation of High-Definition Multimedia Interface, which is an AV digital interface that can be connected to a TV or amplifier.

With the HDMI connection, high definition video and high quality audio formats adopted by Blu-ray disc players (Dolby Digital Plus, Dolby TrueHD, DTS-HD, DTS-HD Master Audio) can be transmitted, which is not possible with the analog video transmission.

Furthermore, in the HDMI connection, audio and video signals can be transmitted through a single HDMI cable, while in conventional connections it is necessary to provide audio and video cables separately for connection between devices.

This allows you to simplify the wiring configuration that tends to be quite complex in a home theater system.

This unit supports the following HDMI functions.

- **Deep Color**

An imaging technology supported by HDMI. Unlike RGB or YCbCr, which uses 8 bits (256 shades) per color, it can use 10 bits (1024 shades), 12 bits (4096 shades), or 16 bits (65536 shades) to produce colors in higher definition. Both devices linked via HDMI must support Deep Color.

- **“x.v.Color”**

This function lets HDTVs display colors more accurately. It enables display with natural, vivid colors.

“x.v.Color” is trademark of Sony Corporation.

- **3D**

This unit supports input and output of 3D (3 dimensional) video signals of HDMI.

To play back 3D video, you need a TV and player that provide support for the HDMI 3D function and a pair of 3D glasses.

- **4K**

This unit supports input and output of 4K Ultra HD (3840 x 2160 pixels) video signals of HDMI.

- **Content Type**

It automatically makes settings suitable for the video output type (content information).

- **Adobe RGB color, Adobe YCC601 color**

The color space defined by Adobe Systems Inc. Because it is a wider color space than RGB, it can produce more vivid and natural images.

- **sYCC601 color**

Each of these color spaces defines a palette of available colors that is larger than the traditional RGB color model.

- **Auto Lip Sync**

This function can automatically correct delay between the audio and video.

Use a TV that is compatible with the Auto Lip Sync function.

- **HDMI pass through**

Even when the power to this unit is set to standby, signals input from the HDMI input connector are output to a TV or other device that is connected to the HDMI output connector.



• HDMI control

If you connect the unit and an HDMI control function compatible TV or player with an HDMI cable and then enable the HDMI control function setting on each device, the devices will be able to control each other.

• Power off link

This unit power off can be linked to the TV power off step.

• Audio output destination switching

From the TV, you can switch whether to output audio from the TV or the AV amplifier.

• Volume adjustment

You can adjust this unit's volume in the TV volume adjustment operation.

• Input source switching

You can switch this unit input sources through linkage to TV input switching.

When playing the player, this unit input source switches to the source for that player.

• ARC (Audio Return Channel)

This function transmits audio signals from the TV to this unit through the HDMI cable and plays back the audio from the TV on this unit based on the HDMI control function.

If a TV without the ARC function is connected via HDMI connections, video signals of the playback device connected to this unit are transmitted to the TV, but this unit can not play back the audio from the TV. If you want to enjoy surround audio for TV program, a separate audio cable connection is required. In contrast, if a TV with the ARC function is connected via HDMI connections, no audio cable connection is required. Audio signals from the TV can be input to this unit through the HDMI cable between this unit and the TV. This function allows you to enjoy surround playback on this unit for the TV.



■ Supported audio formats

2-channel Linear PCM	2-channel, 32 kHz – 192 kHz, 16/20/24 bit
Multi-channel Linear PCM	7.1-channel, 32 kHz – 192kHz, 16/20/24 bit
Bitstream	Dolby Digital / DTS / Dolby TrueHD / Dolby Digital Plus / DTS-HD Master Audio / DTS-HD High Resolution Audio / DTS Express

■ Supported video signals

- 480i
- 480p
- 576p
- 720p 60/50Hz
- 1080p 60/50/24Hz
- 4K 30/25/24Hz
- 576i
- 1080i 60/50Hz

Copyright protection system

In order to play back digital video and audio such as BD-Video (Blu-ray Disc) or DVD-Video via HDMI connection, both this unit and TV and the player need to support the copyright protection system known as HDCP (High-bandwidth Digital Content Protection System). HDCP is copyright protection technology comprised of data encryption and authentication of the connected AV devices. This unit supports HDCP.

- If a device that does not support HDCP is connected, video and audio are not output correctly. Read the owner's manual of your television or player for more information.



- When connecting this unit to a device that is compatible with the Deep Color, 4K, ARC function, use a "High Speed HDMI cable with Ethernet".



Video conversion function

This unit automatically converts the input video signals as shown in the diagram below before outputting them to the TV.

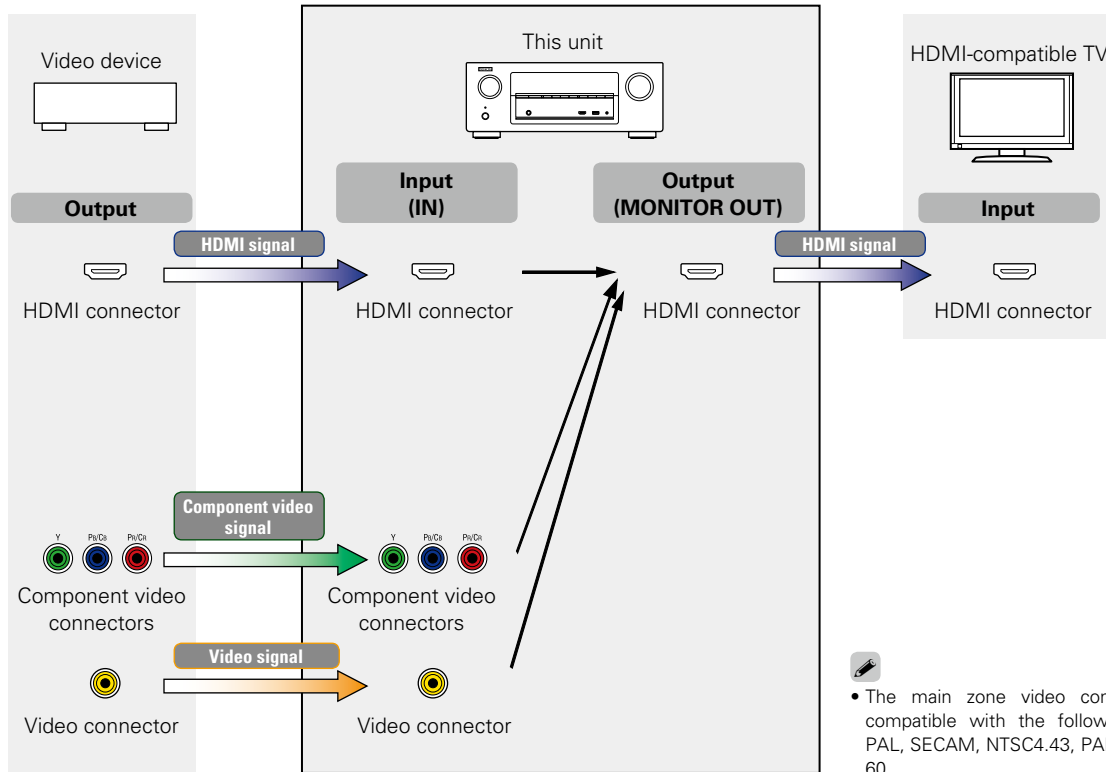

This unit can convert the input video signals to the resolution that is set for "Resolution" (see page 135) in the menu before outputting them to the TV.

Input signal \ Output signal		HDMI						
		480i/576i	480p/576p	720p	1080i	1080p	1080p 24Hz	4K 30/25/24Hz
HDMI	480i/576i	✓	✓	✓	✓	✓	✓	✓
	480p/576p		✓	✓	✓	✓	✓	✓
	720p			✓	✓	✓	✓	✓
	1080i			✓	✓	✓	✓	✓
	1080p 24Hz					✓	✓	✓
	1080p					✓	✓	✓
	4K 30/25/24Hz							✓
Component Video	480i/576i	✓	✓	✓	✓	✓	✓	✓
	480p/576p		✓	✓	✓	✓	✓	✓
	720p			✓	✓	✓	✓	✓
	1080i			✓	✓	✓	✓	✓
	1080p					✓	✓	✓
Video	480i/576i	✓	✓	✓	✓	✓	✓	✓



Playing back USB memory devices

- This unit is compatible with MP3 ID3-Tag (Ver. 2) standard.
- This unit can show the artwork that was embedded by using MP3 ID3-Tag Ver. 2.3 or 2.4.
- This unit is compatible with WMA META tags.
- If the image size (pixels) of an album artwork exceeds 500 × 500 (WMA/MP3/WAV/FLAC) or 349 × 349 (MPEG-4 AAC), then music may not be played back properly.

Compatible formats

	Sampling frequency	Bit rate	Extension
WMA (Windows Media Audio)*1	32/44.1/48 kHz	48 – 192 kbps	.wma
MP3 (MPEG-1 Audio Layer-3)	32/44.1/48 kHz	32 – 320 kbps	.mp3
WAV	32/44.1/48/88.2/96/ 176.4/192 kHz	–	.wav
MPEG-4 AAC *2	32/44.1/48 kHz	16 – 320 kbps	.aac/ .m4a/ .mp4
FLAC (Free Lossless Audio Codec)	32/44.1/48/88.2/96/ 176.4/192 kHz	–	.flac
ALAC (Apple Lossless Audio Codec)*3	32/44.1/48/88.2/96 kHz	–	.m4a

- *1 Copyright-protected files can be played on certain portable players compatible with MTP.
- *2 Only files that are not protected by copyright can be played on this unit. Content downloaded from pay sites on the Internet are copyright protected. Also, files encoded in WMA format when ripped from a CD, etc. on a computer may be copyright protected, depending on the computer's settings.
- *3 Copyright [2012] [D&M Holdings, Inc.]
Licensed under the Apache License, Version 2.0 (the "License"); you may not use this file except in compliance with the License. You may obtain a copy of the License at <http://www.apache.org/licenses/LICENSE-2.0>.

Maximum Number of Playable Files and Folder

The limits on the number of folders and files that can be displayed by this unit are as follows.

Item	Media	USB memory devices
Memory capacity		FAT16 : 2 GB, FAT32 : 2 TB
Number of folder directory levels*1		8 levels
Number of folders		500
Number of files*2		5000

*1 The limited number includes the root folder.

*2 The allowable number of files may differ according to the USB memory device capacity and the file size.



Playing back files stored on PC or NAS

- This unit is compatible with MP3 ID3-Tag (Ver. 2) standard.
- This unit can show the artwork that was embedded by using MP3 ID3-Tag Ver. 2.3 or 2.4.
- This unit is compatible with WMA META tags.
- If the image size (pixels) of an album artwork exceeds 500 × 500 (WMA/MP3/WAV/FLAC) or 349 × 349 (MPEG-4 AAC), then music may not be played back properly.
- A server or server software compatible with distribution in the corresponding formats is required to play music files via a network.

■ Specifications of supported files

	Sampling frequency	Bit rate	Extension
WMA (Windows Media Audio)	32/44.1/48 kHz	48 – 192 kbps	.wma
MP3 (MPEG-1 Audio Layer-3)	32/44.1/48 kHz	32 – 320 kbps	.mp3
WAV	32/44.1/48/88.2/96/ 176.4/192 kHz	–	.wav
MPEG-4 AAC*1	32/44.1/48 kHz	16 – 320 kbps	.aac/ .m4a/ .mp4
FLAC (Free Lossless Audio Codec)	32/44.1/48/88.2/96/ 176.4/192 kHz	–	.flac
ALAC (Apple Lossless Audio Codec)*2	32/44.1/48/88.2/96 kHz	–	.m4a

*1 Only files that are not protected by copyright can be played on this unit. Content downloaded from pay sites on the Internet are copyright protected. Also, files encoded in WMA format when ripped from a CD, etc. on a computer may be copyright protected, depending on the computer's settings.

*2 Copyright [2012] [D&M Holdings. Inc.] Licensed under the Apache License, Version 2.0 (the "License"); you may not use this file except in compliance with the License. You may obtain a copy of the License at <http://www.apache.org/licenses/LICENSE-2.0>.



Playing back Internet Radio

■ Playable broadcast station specifications

	Sampling frequency	Bit rate	Extension
WMA (Windows Media Audio)	32/44.1/48 kHz	48 – 192 kbps	.wma
MP3 (MPEG-1 Audio Layer-3)	32/44.1/48 kHz	32 – 320 kbps	.mp3
MPEG-4 AAC	32/44.1/48 kHz	16 – 320 kbps	.aac/ .m4a/ .mp4

Personal memory plus function

This function sets the settings (input mode, sound mode, HDMI output mode, MultEQ® XT, Dynamic EQ, audio delay etc.) last selected for the individual input sources.



- The surround parameters, tone control settings are stored for the individual sound modes.

Last function memory

This function stores the settings which were made before going into the standby mode.



Sound modes and channel output

- This indicates the audio output channels or surround parameters that can be set.
 ◎ This indicates the audio output channels. The output channels depend on the settings of "Speaker Config." (☞ page 151).

Sound mode (☞ page 94)	Channel output					
	Front L/R	Center	Surround L/R	Surround back L/R	Front height L/R	Subwoofer
DIRECT/PURE DIRECT (2-channel)	○					◎*3
DIRECT/PURE DIRECT (Multi-channel)	○	◎	◎	◎*1	◎*1	◎
STEREO	○					◎
MULTI CH IN	○	◎	◎	◎*1		◎
DOLBY PRO LOGIC IIz	○	◎	◎		◎*2	◎
DOLBY PRO LOGIC IIx	○	◎	◎	◎		◎
DOLBY PRO LOGIC II	○	◎	◎			◎
DTS NEO:6	○	◎	◎	◎		◎
DOLBY DIGITAL	○	◎	◎	◎	◎*2	◎
DOLBY DIGITAL Plus	○	◎	◎	◎*1	◎*1	◎
DOLBY TrueHD	○	◎	◎	◎*1	◎*1	◎
DTS SURROUND	○	◎	◎	◎	◎*2	◎
DTS 96/24	○	◎	◎	◎	◎*2	◎
DTS-HD	○	◎	◎	◎*1	◎*1	◎
DTS Express	○	◎	◎	◎	◎*2	◎
MULTI CH STEREO	○	◎	◎	◎		◎
ROCK ARENA	○	◎	◎	◎	◎	◎
JAZZ CLUB	○	◎	◎	◎	◎	◎
MONO MOVIE	○	◎	◎	◎	◎	◎
VIDEO GAME	○	◎	◎	◎	◎	◎
MATRIX	○	◎	◎	◎	◎	◎
VIRTUAL	○					◎

*1 A signal for each channel contained in an input signal is output as audio.

*2 Audio is output when the set sound mode name contains "+PLIIz".

*3 Audio is output when "Subwoofer Mode" (☞ page 155) in the menu is set to "LFE+Main".



Sound modes and surround parameters

Sound mode (🔗 page 94)	Surround Parameter (🔗 page 123)									
	Dialog Level (🔗 page 122)	Subwoofer Level (🔗 page 122)	Cinema EQ (🔗 page 123)	Loudness Management *1 (🔗 page 123)	Dynamic Compression *2 (🔗 page 123)	Low Frequency Effects *3 (🔗 page 124)	Delay Time (🔗 page 125)	Effect Level (🔗 page 125)	Room Size (🔗 page 125)	Height Gain *4 (🔗 page 125)
DIRECT/PURE DIRECT (2-channel)*5		○*6		○	○					
DIRECT/PURE DIRECT (Multi-channel)*5	○	○		○	○					
STEREO		○		○	○	○				
MULTI CH IN	○	○	○*7			○				○
DOLBY PRO LOGIC IIz	○	○	○	○	○					○
DOLBY PRO LOGIC IIx	○	○	○*8	○	○					
DOLBY PRO LOGIC II	○	○	○*8	○	○					
DTS NEO:6	○	○	○*8	○	○					
DOLBY DIGITAL	○	○	○*7		○	○				○
DOLBY DIGITAL Plus	○	○	○*7		○	○				○
DOLBY TrueHD	○	○	○*7	○	○	○				○
DTS SURROUND	○	○	○*7		○	○				○
DTS 96/24	○	○	○*7			○				○
DTS-HD	○	○	○*7			○				○
DTS Express	○	○	○*7			○				○
MULTI CH STEREO	○	○		○	○	○				
ROCK ARENA	○	○		○	○	○		○	○	
JAZZ CLUB	○	○		○	○	○		○	○	
MONO MOVIE	○	○		○	○	○		○	○	
VIDEO GAME	○	○		○	○	○		○	○	
MATRIX	○	○		○	○	○	○			
VIRTUAL		○		○	○	○				

*1 - *8 : 🔗 page 195



Sound mode (☞ page 94)	Surround Parameter (☞ page 123)				Tone *9 (☞ page 126)	Audyssey (☞ page 128)			Restorer *12 (☞ page 126)
	PRO LOGIC II/IIx Music mode only			NEO:6 Music mode only		MultEQ® XT *10 (☞ page 128)	Dynamic EQ *11 (☞ page 128)	Dynamic Volume *11 (☞ page 129)	
	Panorama (☞ page 124)	Dimension (☞ page 124)	Center Width (☞ page 125)	Center Image (☞ page 124)					
DIRECT/PURE DIRECT (2-channel)*5									
DIRECT/PURE DIRECT (Multi-channel)*5									
STEREO					<input type="radio"/>	<input type="radio"/>	<input type="radio"/>	<input type="radio"/>	<input type="radio"/>
MULTI CH IN					<input type="radio"/>	<input type="radio"/>	<input type="radio"/>	<input type="radio"/>	
DOLBY PRO LOGIC IIz					<input type="radio"/>	<input type="radio"/>	<input type="radio"/>	<input type="radio"/>	<input type="radio"/>
DOLBY PRO LOGIC IIx	<input type="radio"/>	<input type="radio"/>	<input type="radio"/>		<input type="radio"/>	<input type="radio"/>	<input type="radio"/>	<input type="radio"/>	<input type="radio"/>
DOLBY PRO LOGIC II	<input type="radio"/>	<input type="radio"/>	<input type="radio"/>		<input type="radio"/>	<input type="radio"/>	<input type="radio"/>	<input type="radio"/>	<input type="radio"/>
DTS NEO:6				<input type="radio"/>	<input type="radio"/>	<input type="radio"/>	<input type="radio"/>	<input type="radio"/>	<input type="radio"/>
DOLBY DIGITAL					<input type="radio"/>	<input type="radio"/>	<input type="radio"/>	<input type="radio"/>	
DOLBY DIGITAL Plus					<input type="radio"/>	<input type="radio"/>	<input type="radio"/>	<input type="radio"/>	
DOLBY TrueHD					<input type="radio"/>	<input type="radio"/>	<input type="radio"/>	<input type="radio"/>	
DTS SURROUND					<input type="radio"/>	<input type="radio"/>	<input type="radio"/>	<input type="radio"/>	
DTS 96/24					<input type="radio"/>	<input type="radio"/>	<input type="radio"/>	<input type="radio"/>	
DTS-HD					<input type="radio"/>	<input type="radio"/>	<input type="radio"/>	<input type="radio"/>	
DTS Express					<input type="radio"/>	<input type="radio"/>	<input type="radio"/>	<input type="radio"/>	
MULTI CH STEREO					<input type="radio"/>	<input type="radio"/>	<input type="radio"/>	<input type="radio"/>	<input type="radio"/>
ROCK ARENA					<input type="radio"/> *13	<input type="radio"/>	<input type="radio"/>	<input type="radio"/>	<input type="radio"/>
JAZZ CLUB					<input type="radio"/>	<input type="radio"/>	<input type="radio"/>	<input type="radio"/>	<input type="radio"/>
MONO MOVIE					<input type="radio"/>	<input type="radio"/>	<input type="radio"/>	<input type="radio"/>	<input type="radio"/>
VIDEO GAME					<input type="radio"/>	<input type="radio"/>	<input type="radio"/>	<input type="radio"/>	<input type="radio"/>
MATRIX					<input type="radio"/>	<input type="radio"/>	<input type="radio"/>	<input type="radio"/>	<input type="radio"/>
VIRTUAL					<input type="radio"/>	<input type="radio"/>	<input type="radio"/>	<input type="radio"/>	<input type="radio"/>

*5, *9 – *13 : ☞ page 195



- *1 This item can be selected when a Dolby TrueHD signal is played.
- *2 This item can be selected when a Dolby Digital or DTS signal is played.
- *3 This item can be selected when a Dolby Digital or DTS signal or DVD-Audio is played.
- *4 This setting is available when the set sound mode name contains "+PLIIz".
- *5 During playback in PURE DIRECT mode, the surround parameters are the same as in DIRECT mode.
- *6 This setting is available when "Subwoofer Mode" ([page 155](#)) in the menu is set to "LFE+Main".
- *7 This setting is available when the set sound mode name contains "+PLII Music".
- *8 This setting is possible when the sound mode is "Cinema" mode.
- *9 This item cannot be set when "Dynamic EQ" ([page 128](#)) is set to "On".
- *10 This item cannot be set when Audyssey® Setup (Speaker Calibration) has not been performed.
- *11 This item cannot be set when "MultEQ® XT" ([page 128](#)) is set to "Off" or "Graphic EQ".
- *12 This item can be set when the input signal is analog, PCM 48 kHz or 44.1 kHz.
- *13 In this sound mode, bass is +6 dB, and treble is +4 dB. (Default)



Types of input signals, and corresponding sound modes

- This indicates the default sound mode.
○ This indicates the selectable sound mode.

Sound mode (☞ page 94)	NOTE	2-channel signal		Multi-channel signal										
		Analog / PCM	Dolby Digital (+/HD) / DTS (+HD)	PCM Multi	DTS-HD	DTS Express	DTS ES DSCRT 6.1	DTS ES MTRIX 6.1	DTS	DOLBY TrueHD	DOLBY DIGITAL Plus	DOLBY DIGITAL EX	DOLBY DIGITAL	
DTS SURROUND														
DTS-HD MSTR					●*6									
DTS-HD HI RES					●*7									
DTS ES DSCRT6.1	*1						●							
DTS ES MTRX6.1	*1							●						
DTS SURROUND														
DTS 96/24													●*8	
DTS (-HD) + PLIIx	*1*2				○	○							○	
DTS (-HD) + PLIIz	*3				○	○	○	○					○	
DTS Express									●					
DTS NEO:6	*4	○	○											
DOLBY SURROUND														
DOLBY TrueHD														
DOLBY TrueHD													●	
DOLBY DIGITAL+														
DOLBY DIGITAL+													●	
DOLBY DIGITAL EX	*1												○	○
DOLBY (D+) (HD) +EX	*1												○	○
DOLBY DIGITAL														
DOLBY DIGITAL													●	●
DOLBY (D) (D+) (HD) + PLIIx	*1*2												○	○
DOLBY (D) (D+) (HD) + PLIIz	*3												○	○
DOLBY PRO LOGIC II/IIx	*5	○	○											
DOLBY PRO LOGIC IIz	*3	○	○											

*1 - *8 : ☞ page 198



Sound mode (page 94)	NOTE	2-channel signal		Multi-channel signal										
		Analog / PCM	Dolby Digital (+/HD) / DTS (-HD)	PCM Multi	DTS-HD	DTS Express	DTS ES DSCRT 6.1	DTS ES MTRIX 6.1	DTS	DOLBY TrueHD	DOLBY DIGITAL Plus	DOLBY DIGITAL EX	DOLBY DIGITAL	
MULTI CH IN														
MULTI CH IN				●										
MULTI CH IN + DOLBY EX	*1			○										
MULTI CH IN + PLIIx	*1*2			○										
MULTI CH IN + PLIIz	*3			○										
MULTI CH IN 7.1	*1			●*10										
DIRECT														
DIRECT		○*9	○	○	○	○	○	○	○	○	○	○	○	○
PURE DIRECT														
PURE DIRECT		○	○	○	○	○	○	○	○	○	○	○	○	○
DSP SIMULATION														
MULTI CH STEREO		○	○	○	○	○	○	○	○	○	○	○	○	○
ROCK ARENA		○	○	○	○	○	○	○	○	○	○	○	○	○
JAZZ CLUB		○	○	○	○	○	○	○	○	○	○	○	○	○
MONO MOVIE		○	○	○	○	○	○	○	○	○	○	○	○	○
VIDEO GAME		○	○	○	○	○	○	○	○	○	○	○	○	○
MATRIX		○	○	○	○	○	○	○	○	○	○	○	○	○
VIRTUAL		○	○	○	○	○	○	○	○	○	○	○	○	○
STEREO														
STEREO		○	○	○	○	○	○	○	○	○	○	○	○	○

*1 - *3, *9, *10 : (page 198)



- *1 This item can be selected when surround back speakers are used.
- *2 The Cinema mode or Music mode can be selected. When using a single surround back speaker, the Music mode is used.
- *3 This item can be selected when front height speakers are used.
- *4 The Cinema mode or Music mode can be selected.
- *5 The Cinema mode, Music mode or Game mode can be selected.
- *6 This item can be selected when the input signal is DTS-HD MASTER AUDIO.
- *7 This item can be selected when the input signal is DTS-HD HI RESOLUTION.
- *8 This item can be selected when the input signal is DTS 96/24.
- *9 The default sound mode for the AirPlay playback is DIRECT.
- *10 This item can be selected when the input signals contain surround back signals.



Explanation of terms

A

AirPlay

AirPlay sends (plays) contents recorded in iTunes or on an iPhone/iPod touch/iPad to a compatible device via the network.

ALAC (Apple Lossless Audio Codec)

This is a codec for lossless audio compression method developed by Apple Inc. This codec can be played back on iTunes, iPod or iPhone. Data compressed to approximately 60 – 70 % can be decompressed to exactly the same original data.

App Store

App Store is a site that sells application software for such devices as the iPhone or iPod Touch, and is operated by Apple Inc.

Audyssey Dynamic EQ®

Dynamic EQ solves the problem of deteriorating sound quality as volume is decreased by taking into account human perception and room acoustics. Audyssey Dynamic EQ® works in tandem with Audyssey MultEQ® XT to provide well-balanced sound for every listener at any volume level.

Audyssey Dynamic Volume®

Dynamic Volume solves the problem of large variations in volume level between television programs, commercials, and between the soft and loud passages of movies. Audyssey Dynamic EQ® is integrated into Dynamic Volume so that as the playback volume is adjusted automatically, the perceived bass response, tonal balance, surround impression, and dialog clarity remain the same.

D

Audyssey MultEQ® XT
MultEQ® XT is a room equalization solution that calibrates any audio system so that it can achieve optimum performance for every listener in a large listening area. Based on several room measurements, MultEQ® XT calculates an equalization solution that corrects for both time and frequency response problems in the listening area and also performs a fully automated surround system setup.

D

DLNA

DLNA and DLNA CERTIFIED are trademarks and/or service marks of Digital Living Network Alliance. Some contents may not be compatible with other DLNA CERTIFIED® products.

Dolby Digital

Dolby Digital is a multi-channel digital signal format developed by Dolby Laboratories.

A total of 5.1-channels are played: 3 front channels ("FL", "FR" and "C"), 2 surround channels ("SL" and "SR") and the "LFE" channel for low frequency effects.

Because of this, there is no crosstalk between channels and a realistic sound field with a "three-dimensional" feeling (sense of distance, movement and positioning) is achieved. This delivers a thrilling surround sound experience in the home.



Dolby Digital EX

Dolby Digital EX is a 6.1-channel surround format from Dolby Laboratories that allows users to enjoy in their homes the “DOLBY DIGITAL SURROUND EX” audio format jointly developed by Dolby Laboratories and Lucasfilm. The 6.1-channels of sound, including surround back channel, provide improved sound positioning and expansion of the surround sound field.

Dolby Digital Plus

Dolby Digital Plus is an improved Dolby Digital signal format that is compatible with up to 7.1-channels of discrete digital sound and also improves sound quality thanks to extra data bit rate performance. It is upwardly compatible with conventional Dolby Digital, so it offers greater flexibility in response to the source signal and the conditions of the playback device.

Dolby Pro Logic II

Dolby Pro Logic II is a matrix decoding technology developed by Dolby Laboratories.

Regular music such as that on CDs is encoded into 5-channels to achieve an excellent surround effect.

The surround channel signals are converted into stereo and full band signals (with a frequency response of 20 Hz to 20 kHz or greater) to create a “three-dimensional” sound image offering a rich sense of presence for all stereo sources.

Dolby Pro Logic IIx

Dolby Pro Logic IIx is a further improved version of the Dolby Pro Logic II matrix decoding technology.

Audio signals recorded in 2-channels are decoded to achieve a natural sound with up to 7.1-channels.

There are three modes: “Music” suited for playing music, “Cinema” suited for playing movies, and “Game” which is optimized for playing games.

Dolby Pro Logic IIz

Dolby Pro Logic IIz introduces a new dimension to Home Entertainment through the addition of a pair of front height channels. Compatible with stereo, 5.1-channel and 7.1-channel content, Dolby Pro Logic IIz provides enhanced spaciousness, depth and dimension to movies, concert video and video game playback while maintaining the full integrity of the source mix.

Dolby Pro Logic IIz identifies and decodes spatial cues that occur naturally in all content, directing this information to the front height channels, complementing the performance of left and right surround sound speakers. Content that is encoded with Dolby Pro Logic IIz height channel information can be even more revealing, with perceptually discrete height channel information bringing an exciting new dimension to home entertainment.

Dolby Pro Logic IIz, with front height channels is also an ideal alternative for households that cannot support the placement of back surround speakers of a typical 7.1-channel system but may have bookshelf space available to support the addition of height speakers.

Dolby TrueHD

Dolby TrueHD is a high definition audio technology developed by Dolby Laboratories, using lossless coding technology to faithfully reproduce the sound of the studio master.

This format provides the facility to support up to 8 audio channels with a sampling frequency of 96 kHz/24 bit resolution and up to 6 audio channels with a sampling frequency of 192 kHz/24 bit resolution. Dolby TrueHD is adopted for applications that put very high importance on sound quality.



Downmix

This function converts the number of channels of surround audio to a lower number of channels and plays back according to the system's configuration.

DTS

This is an abbreviation of Digital Theater System, which is a digital audio system developed by DTS.

DTS delivers a powerful and dynamic surround sound experience, and is found in the world's finest movie theaters and screening rooms.

DTS 96/24

DTS 96/24 is a digital audio format enabling high sound quality playback in 5.1-channels with a sampling frequency of 96 kHz and 24 bit quantization on DVD-Video.

DTS Digital Surround

DTS Digital Surround is the standard digital surround format of DTS, Inc., compatible with a sampling frequency of 44.1 or 48 kHz and up to 5.1-channels of digital discrete surround sound.

DTS-ES™ Discrete 6.1

DTS-ES™ Discrete 6.1 is a 6.1-channel discrete digital audio format adding a surround back (SB) channel to the DTS digital surround sound.

Decoding of conventional 5.1-channel audio signals is also possible according to the decoder.

DTS-ES™ Matrix 6.1

DTS-ES™ Matrix 6.1 is a 6.1-channel audio format that inserts a surround back (SB) channel to the DTS digital surround sound through matrix encoding. Decoding of conventional 5.1-channel audio signals is also possible according to the decoder.

DTS Express

DTS Express is an audio format supporting low bit rates (max. 5.1-channels, 24 to 256 kbps).

DTS-HD

This audio technology provides higher sound quality and enhanced functionality than the conventional DTS and is adopted as an optional audio for Blu-ray Disc. This technology supports multi-channel, high data transfer speed, high sampling frequency, and lossless audio playback. Maximum 7.1-channels are supported in Blu-ray Disc.

DTS-HD High Resolution Audio

DTS-HD High Resolution Audio is an improved version of the conventional DTS, DTS-ES and DTS 96/24 signals formats, compatible with sampling frequencies of 96 or 48 kHz and up to 7.1-channels of discrete digital sound. High data bit rate performance provides high quality sound. This format is fully compatible with conventional products, including conventional DTS digital surround 5.1-channel data.

DTS-HD Master Audio

DTS-HD Master Audio is a lossless audio format created by Digital Theater System (DTS). This format provides the facility to support up to 8 audio channels with a sampling frequency of 96 kHz/24 bit resolution and up to 6 audio channels with a sampling frequency of 192 kHz/24 bit resolution. It is fully compatible with conventional products, including conventional DTS digital surround 5.1-channel data.

DTS NEO:6™ Surround

DTS NEO:6™ is a matrix decoding technology for achieving 6.1-channel surround playback with 2-channel sources. It includes "DTS NEO:6 Cinema" suited for playing movies and "DTS NEO:6 Music" suited for playing music.



Dynamic range

The difference between the maximum undistorted sound level and the minimum discernible level above the noise emitted by the device.

F

FLAC

FLAC stands for Free lossless Audio Codec, and is a lossless free audio file format. Lossless means that the audio is compressed without any loss in quality.

The FLAC license is as shown below.

Copyright (C) 2000, 2001, 2002, 2003, 2004, 2005, 2006, 2007, 2008, 2009 Josh Coalson

Redistribution and use in source and binary forms, with or without modification, are permitted provided that the following conditions are met:

- Redistributions of source code must retain the above copyright notice, this list of conditions and the following disclaimer.
- Redistributions in binary form must reproduce the above copyright notice, this list of conditions and the following disclaimer in the documentation and/or other materials provided with the distribution.
- Neither the name of the Xiph.org Foundation nor the names of its contributors may be used to endorse or promote products derived from this software without specific prior written permission.

THIS SOFTWARE IS PROVIDED BY THE COPYRIGHT HOLDERS AND CONTRIBUTORS "AS IS" AND ANY EXPRESS OR IMPLIED WARRANTIES, INCLUDING, BUT NOT LIMITED TO, THE IMPLIED WARRANTIES OF MERCHANTABILITY AND FITNESS FOR A PARTICULAR PURPOSE ARE DISCLAIMED. IN NO EVENT SHALL THE FOUNDATION OR CONTRIBUTORS BE LIABLE FOR ANY DIRECT, INDIRECT, INCIDENTAL, SPECIAL, EXEMPLARY, OR CONSEQUENTIAL DAMAGES (INCLUDING, BUT NOT LIMITED TO, PROCUREMENT OF SUBSTITUTE GOODS OR SERVICES; LOSS OF USE, DATA, OR PROFITS; OR BUSINESS INTERRUPTION) HOWEVER CAUSED AND ON ANY THEORY OF LIABILITY, WHETHER IN CONTRACT, STRICT LIABILITY, OR TORT (INCLUDING NEGLIGENCE OR OTHERWISE) ARISING IN ANY WAY OUT OF THE USE OF THIS SOFTWARE, EVEN IF ADVISED OF THE POSSIBILITY OF SUCH DAMAGE.

H

HDCP

When transmitting digital signals between devices, this copyright protection technology encrypts the signals to prevent content from being copied without authorization.

I

iTunes

iTunes is the name of the multimedia player provided by Apple Inc. It enables management and playback of multimedia contents including music and movies. iTunes supports many main file formats including AAC, WAV, and MP3.



L

LFE

This is an abbreviation of Low Frequency Effect, which is an output channel that emphasizes low frequency effect sound. Surround audio is intensified by outputting 20 Hz to 120 Hz deep bass to the system subwoofer(s).

M

MAIN ZONE

The room where this unit is placed is called the MAIN ZONE.

Modem

Device that connects to your broadband internet provider, and is very often supplied with the service.

A type that is integrated with a router is also often available.

MP3 (MPEG Audio Layer-3)

This is an internationally standardized audio data compression scheme, using the "MPEG-1" video compression standard. It compresses the data volume to about one eleventh its original size while maintaining sound quality equivalent to a music CD.

MPEG (Moving Picture Experts Group),**MPEG-2, MPEG-4**

These are the names for digital compression format standards used for the encoding of video and audio. Video standards include "MPEG-1 Video", "MPEG-2 Video", "MPEG-4 Visual", "MPEG-4 AVC". Audio standards include "MPEG-1 Audio", "MPEG-2 Audio", "MPEG-4 AAC".

P

Progressive (sequential scanning)

This is a scanning system of the video signal that displays 1 frame of video as one image. Compared to the interlace system, this system provides images with less flickering and jagged edges.

Protection circuit

This is a function to prevent damage to devices within the power supply when an abnormality such as an overload, excess voltage occurs or over temperature for any reason.

If a malfunction occurs in this unit, the power indicator blinks red and the unit switches to standby mode.

S

Sampling frequency

Sampling involves taking a reading of a sound wave (analog signal) at regular intervals and expressing the height of the wave at each reading in digitized format (producing a digital signal).

The number of readings taken in one second is called the "sampling frequency". The larger the value, the closer the reproduced sound is to the original.

Speaker impedance

This is an AC resistance value, indicated in Ω (Ohms). Greater power can be obtained when this value is smaller.



V

vTuner

This is a free online content server for Internet Radio. Note that usage fees are included in upgrade costs.

For inquiries about this service, visit the vTuner site below.

vTuner website: <http://www.radiodeno.com>

This product is protected by certain intellectual property rights of Nothing Else Matters Software and BridgeCo. Use or distribution of such technology outside of this product is prohibited without a license from Nothing Else Matters Software and BridgeCo or an authorized subsidiary.

W

Windows Media DRM

This is a copyright protection technology developed by Microsoft. Content providers are using the digital rights management technology for Windows Media contained in this device (WM-DRM) to protect the integrity of their content (Secure Content) so that their intellectual property, including copyright, in such content is not misappropriated. This device uses WM-DRM software to play Secure Content (WM-DRM Software). If the security of the WM-DRM Software in this device has been compromised, owners of Secure Content (Secure Content Owners) may request that Microsoft revoke the WM-DRM Software's right to acquire new licenses to copy, display and/or play Secure Content. Revocation does not alter the WM-DRM Software's ability to play unprotected content. A list of revoked WM-DRM Software is sent to your device whenever you download a license for Secure Content from the Internet or from a PC. Microsoft may, in conjunction with such license, also download revocation list onto your device on behalf of Secure Content Owners.

Windows Media Player Ver.11 or later

This is a media player distributed free of charge by Microsoft Corporation. It can play playlists created with Ver.11 or later of Windows Media Player, as well as WMA, DRM WMA, WAV, and other files.

WMA (Windows Media Audio)

This is audio compression technology developed by Microsoft Corporation. WMA data can be encoded using Windows Media® Player.

To encode WMA files, only use applications authorized by Microsoft Corporation. If you use an unauthorized application, the file may not work properly.

Z

ZONE2

This unit can operate in a room other than the room where this unit is placed (MAIN ZONE) (ZONE2 playback). The room for ZONE2 playback is called ZONE2.



Trademark information



Manufactured under license from Audyssey Laboratories™. U.S. and foreign patents pending. Audyssey MultEQ® XT, Audyssey Dynamic EQ® and Audyssey Dynamic Volume® are registered trademarks of Audyssey Laboratories.



Manufactured under license from Dolby Laboratories. “Dolby”, “Pro Logic” and the double-D symbol are trademarks of Dolby Laboratories.



Manufactured under license under U.S. Patent Nos: 5,956,674; 5,974,380; 6,226,616; 6,487,535; 7,212,872; 7,333,929; 7,392,195; 7,272,567 & other U.S. and worldwide patents issued & pending. DTS-HD, the Symbol, & DTS-HD and the Symbol together are registered trademarks & DTS-HD Master Audio is a trademark of DTS, Inc. Product includes software. © DTS, Inc. All Rights Reserved.

HDMI

The terms HDMI and HDMI High-Definition Multimedia Interface, and the HDMI Logo are trademarks or registered trademarks of HDMI Licensing LLC in the United States and other countries.



“Made for iPod” and “Made for iPhone” mean that an electronic accessory has been designed to connect specifically to iPod, or iPhone, respectively, and has been certified by the developer to meet Apple performance standards.

Apple is not responsible for the operation of this device or its compliance with safety and regulatory standards. Please note that the use of this accessory with iPod, or iPhone, may affect wireless performance.

AirPlay, the AirPlay logo, iPad, iPhone, iPod, iPod classic, iPod nano, iPod shuffle and iPod touch are trademarks of Apple Inc., registered in the U.S. and other countries.

- Individual users are permitted to use iPhone, iPod, iPod classic, iPod nano, iPod shuffle, and iPod touch for private copy and playback of non-copyrighted contents and contents whose copy and playback is permitted by law. Copyright infringement is prohibited by law.





Windows Media and the Windows logo are trademarks or registered trademarks of Microsoft Corporation in the United States and/or other countries.



Adobe, the Adobe logo and Reader are either registered trademarks or trademarks of Adobe Systems Incorporated in the United States and/or other countries.



Specifications

■ Audio section

• Power amplifier

Rated output:

Front:

95 W + 95 W (8 Ω /ohms, 20 Hz – 20 kHz with 0.08 % T.H.D.)

125 W + 125 W (6 Ω /ohms, 1 kHz with 0.7 % T.H.D.)

Center:

95 W (8 Ω /ohms, 20 Hz – 20 kHz with 0.08 % T.H.D.)

125 W (6 Ω /ohms, 1 kHz with 0.7 % T.H.D.)

Surround:

95 W + 95 W (8 Ω /ohms, 20 Hz – 20 kHz with 0.08 % T.H.D.)

125 W + 125 W (6 Ω /ohms, 1 kHz with 0.7 % T.H.D.)

Surround back:

95 W + 95 W (8 Ω /ohms, 20 Hz – 20 kHz with 0.08 % T.H.D.)

125 W + 125 W (6 Ω /ohms, 1 kHz with 0.7 % T.H.D.)

6 – 16 Ω /ohms

Output connectors:

• Analog

Input sensitivity/Input impedance:

200 mV/47 k Ω /kohms

Frequency response:

10 Hz – 100 kHz — +1, -3 dB (DIRECT mode)

S/N:

100 dB (IHF-A weighted, DIRECT mode)



■ Tuner section

Receiving Range:

Usable Sensitivity:

50 dB Quietening Sensitivity:

S/N :

Total harmonic Distortion:

[FM]

(Note: μV at $75 \Omega/\text{ohms}$, $0 \text{ dBf} = 1 \times 10^{-15} \text{ W}$)

87.5 MHz – 108.0 MHz

1.2 μV (12.8 dBf)

MONO 2.8 μV (20.2 dBf)

MONO 70 dB (IHF-A weighted, DIRECT mode)

STEREO 67 dB (IHF-A weighted, DIRECT mode)

MONO 0.7 % (1 kHz)

STEREO 1.0 % (1 kHz)

■ General

Power supply:

AC 230 V, 50/60 Hz

Power consumption:

500 W

Power consumption in standby mode:

0.1 W

Power consumption in CEC standby mode:

0.5 W

Power consumption in network standby mode: 2.7 W

For purposes of improvement, specifications and design are subject to change without notice.



Index

Numerics

3D	184
4K	184
5.1-channel	22
6.1-channel	21
7.1-channel	21, 22, 26, 27

A

Accessories	6
Add New Feature	165
Adjusting the master volume	43
AirPlay	83, 199
ALAC	199
App Store	199
Audio settings	122
Audyssey Dynamic EQ®	199
Audyssey Dynamic Volume®	199
Audyssey MultEQ® XT	199
Audyssey settings	128, 143
Audyssey® Setup	141
Auto Standby	162

B

Bi-amp	28
--------------	----

C

Cables	19
Connection	
FM	38
Home network (LAN)	39
iPod (USB)	36
Power cord	40
Speaker	23
TV	30, 31
USB memory device	36
Video camcorder	35
Content Type	184
Convenient function menu	
All Zone Stereo	93
Picture Mode	92
Random	87
Remove from Favorites	89
Repeat	87
Save to Favorites	88
Slideshow	90
Slideshow Interval	91
Text Search	89
Video Select	91

D

Deep Color	184
Display	13
DLNA	199

Dolby

Dolby Digital	97, 199
Dolby Digital EX	97, 200
Dolby Digital Plus	97, 200
Dolby Pro Logic II	97, 200
Dolby Pro Logic IIx	97, 200
Dolby Pro Logic IIz	97, 200
Dolby TrueHD	97, 200
Downmix	201
DTS	201
DTS 96/24	98, 201
DTS Digital Surround	201
DTS-ES Discrete 6.1	98, 201
DTS-ES Matrix 6.1	98, 201
DTS Express	98, 201
DTS-HD	98, 201
DTS-HD High Resolution Audio	201
DTS-HD Master Audio	201
DTS Neo:6	98
DTS NEO:6™ Surround	201
Dynamic range	202

E

Error messages (Audyssey® Setup)	148
--	-----

F

Firmware update	164
FLAC	202
Flickr	73
FM	51
FM indoor antenna	38
Front height speaker	21, 27
Front panel	10



**H**

HDCP	186, 202
HDMI control	105, 133
Headphones	11

**I**

Information	162
Audio	162
Firmware	163
Notifications	163
Video	163
ZONE	163
Input signal	196
Inputting characters	121
iPod Browse Mode	46
iTunes	202

**L**

Last.fm	68
LFE	203
Listening position	142

**M**

MAIN ZONE	203
Menu map	114
Audio	114, 122
General	118, 160
Inputs	117, 137
Network	118, 156
Setup Assistant	119
Speakers	117, 141
Video	116, 131
Modem	203
MP3	203
MPEG	203

**N**

Network settings	156
------------------------	-----

**P**

Playback	
ALAC	48, 64
Blu-ray Disc player	43
DVD player	43
FLAC	48, 64
Flickr	73
FM	52
Internet Radio	60
iPod (USB)	44
JPEG	48, 64
Last.fm	68
MP3	48, 60, 64
MPEG-4 AAC	48, 60, 64
NAS	64
PC	64
PTY	54
Radio Text	56
RDS	54
Spotify	77
TP	55
USB memory device	48
WAV	48, 64
WMA	48, 60, 64
ZONE2	112
Protection circuit	203
PTY	54

**Q**

Quick select	107
--------------------	-----

**R**

Radio Text	56
Random	47, 87
RDS	54
Rear panel	15
Remote control unit	17
Inserting the batteries	7
Repeat	47, 87
Resetting the microprocessor	183

**S**

Sampling frequency	203
Selecting the input source	42
Sleep timer	106
Sound mode	94, 101, 193
Direct	96, 100
Dolby	97
DTS	98
Original	99
PCM multi-channel	98
Pure Direct	96, 100
Stereo	100
Speaker	
Connect	23
Install	20
Set up	141
Speaker impedance	203
Spotify	77
Surround back speaker	21, 26



**T**

Tips	169
TP	55
Troubleshooting	171
Tuner operation menu	
Auto Preset Memory	58
Direct Tune	53
Preset Memory	57
Preset Name	58
Preset Skip	59
Tune Mode	56
Turning off the sound temporarily	43
Turning the power on	42

**V**

Video conversion	187
Video settings	131
vTuner	63, 204

**W**

Web control	108
Windows Media DRM	204
Windows Media Player	204
WMA	204

**Z**

ZONE2	13, 110, 204
-------------	--------------



License

This section describes software license used for this unit. To maintain the correct content, the original (English) is used.

□ Boost

<http://www.boost.org/>

Boost Software License - Version 1.0 - August 17th, 2003

Permission is hereby granted, free of charge, to any person or organization obtaining a copy of the software and accompanying documentation covered by this license (the "Software") to use, reproduce, display, distribute, execute, and transmit the Software, and to prepare derivative works of the Software, and to permit third-parties to whom the Software is furnished to do so, all subject to the following:

The copyright notices in the Software and this entire statement, including the above license grant, this restriction and the following disclaimer, must be included in all copies of the Software, in whole or in part, and all derivative works of the Software, unless such copies or derivative works are solely in the form of machine-executable object code generated by a source language processor.

THE SOFTWARE IS PROVIDED "AS IS", WITHOUT WARRANTY OF ANY KIND, EXPRESS OR IMPLIED, INCLUDING BUT NOT LIMITED TO THE WARRANTIES OF MERCHANTABILITY, FITNESS FOR A PARTICULAR PURPOSE, TITLE AND NON-INFRINGEMENT. IN NO EVENT SHALL THE COPYRIGHT HOLDERS OR ANYONE DISTRIBUTING THE SOFTWARE BE LIABLE FOR ANY DAMAGES OR OTHER LIABILITY, WHETHER IN CONTRACT, TORT OR OTHERWISE, ARISING FROM, OUT OF OR IN CONNECTION WITH THE SOFTWARE OR THE USE OR OTHER DEALINGS IN THE SOFTWARE.

□ Expat

<http://www.jclark.com/xml/expat.html>

Expat License. Copyright (c) 1998, 1999, 2000 Thai Open Source Software Center Ltd

Permission is hereby granted, free of charge, to any person obtaining a copy of this software and associated documentation files (the "Software"), to deal in the Software without restriction, including without limitation the rights to use, copy, modify, merge, publish, distribute, sublicense, and/or sell copies of the Software, and to permit persons to whom the Software is furnished to do so, subject to the following conditions:

The above copyright notice and this permission notice shall be included in all copies or substantial portions of the Software.

THE SOFTWARE IS PROVIDED "AS IS", WITHOUT WARRANTY OF ANY KIND, EXPRESS OR IMPLIED, INCLUDING BUT NOT LIMITED TO THE WARRANTIES OF MERCHANTABILITY, FITNESS FOR A PARTICULAR PURPOSE AND NON-INFRINGEMENT. IN NO EVENT SHALL THE AUTHORS OR COPYRIGHT HOLDERS BE LIABLE FOR ANY CLAIM, DAMAGES OR OTHER LIABILITY, WHETHER IN AN ACTION OF CONTRACT, TORT OR OTHERWISE, ARISING FROM, OUT OF OR IN CONNECTION WITH THE SOFTWARE OR THE USE OR OTHER DEALINGS IN THE SOFTWARE.

□ FastDelegate

<http://www.codeproject.com/KB/cpp/FastDelegate.asp>

THE WORK (AS DEFINED BELOW) IS PROVIDED UNDER THE TERMS OF THIS CODE PROJECT OPEN LICENSE ("LICENSE"). THE WORK IS PROTECTED BY COPYRIGHT AND/OR OTHER APPLICABLE LAW. ANY USE OF THE WORK OTHER THAN AS AUTHORIZED UNDER THIS LICENSE OR COPYRIGHT LAW IS PROHIBITED.

BY EXERCISING ANY RIGHTS TO THE WORK PROVIDED HEREIN, YOU ACCEPT AND AGREE TO BE BOUND BY THE TERMS OF THIS LICENSE. THE AUTHOR GRANTS YOU THE RIGHTS CONTAINED HEREIN IN CONSIDERATION OF YOUR ACCEPTANCE OF SUCH TERMS AND CONDITIONS. IF YOU DO NOT AGREE TO ACCEPT AND BE BOUND BY THE TERMS OF THIS LICENSE, YOU CANNOT MAKE ANY USE OF THE WORK.

1. Definitions.

- a. "Articles" means, collectively, all articles written by Author which describes how the Source Code and Executable Files for the Work may be used by a user.
- b. "Author" means the individual or entity that offers the Work under the terms of this License.
- c. "Derivative Work" means a work based upon the Work or upon the Work and other pre-existing works.
- d. "Executable Files" refer to the executables, binary files, configuration and any required data files included in the Work.
- e. "Publisher" means the provider of the website, magazine, CD-ROM, DVD or other medium from or by which the Work is obtained by You.
- f. "Source Code" refers to the collection of source code and configuration files used to create the Executable Files.



- g. “Standard Version” refers to such a Work if it has not been modified, or has been modified in accordance with the consent of the Author, such consent being in the full discretion of the Author.
- h. “Work” refers to the collection of files distributed by the Publisher, including the Source Code, Executable Files, binaries, data files, documentation, whitepapers and the Articles.
- i. “You” is you, an individual or entity wishing to use the Work and exercise your rights under this License.
2. Fair Use/Fair Use Rights. Nothing in this License is intended to reduce, limit, or restrict any rights arising from fair use, fair dealing, first sale or other limitations on the exclusive rights of the copyright owner under copyright law or other applicable laws.
3. License Grant. Subject to the terms and conditions of this License, the Author hereby grants You a worldwide, royalty-free, non-exclusive, perpetual (for the duration of the applicable copyright) license to exercise the rights in the Work as stated below:
- You may use the standard version of the Source Code or Executable Files in Your own applications.
 - You may apply bug fixes, portability fixes and other modifications obtained from the Public Domain or from the Author. A Work modified in such a way shall still be considered the standard version and will be subject to this License.
 - You may otherwise modify Your copy of this Work (excluding the Articles) in any way to create a Derivative Work, provided that You insert a prominent notice in each changed file stating how, when and where You changed that file.
 - You may distribute the standard version of the Executable Files and Source Code or Derivative Work in aggregate with other (possibly commercial) programs as part of a larger (possibly commercial) software distribution.
- e. The Articles discussing the Work published in any form by the author may not be distributed or republished without the Author’s consent. The author retains copyright to any such Articles. You may use the Executable Files and Source Code pursuant to this License but you may not repost or republish or otherwise distribute or make available the Articles, without the prior written consent of the Author.
- Any subroutines or modules supplied by You and linked into the Source Code or Executable Files this Work shall not be considered part of this Work and will not be subject to the terms of this License.
4. Patent License. Subject to the terms and conditions of this License, each Author hereby grants to You a perpetual, worldwide, non-exclusive, no-charge, royalty-free, irrevocable (except as stated in this section) patent license to make, have made, use, import, and otherwise transfer the Work.
5. Restrictions. The license granted in Section 3 above is expressly made subject to and limited by the following restrictions:
- You agree not to remove any of the original copyright, patent, trademark, and attribution notices and associated disclaimers that may appear in the Source Code or Executable Files.
 - You agree not to advertise or in any way imply that this Work is a product of Your own.
 - The name of the Author may not be used to endorse or promote products derived from the Work without the prior written consent of the Author.
 - You agree not to sell, lease, or rent any part of the Work. This does not restrict you from including the Work or any part of the Work inside a larger software distribution that itself is being sold. The Work by itself, though, cannot be sold, leased or rented.
- e. You may distribute the Executable Files and Source Code only under the terms of this License, and You must include a copy of, or the Uniform Resource Identifier for, this License with every copy of the Executable Files or Source Code You distribute and ensure that anyone receiving such Executable Files and Source Code agrees that the terms of this License apply to such Executable Files and/or Source Code. You may not offer or impose any terms on the Work that alter or restrict the terms of this License or the recipients’ exercise of the rights granted hereunder. You may not sublicense the Work. You must keep intact all notices that refer to this License and to the disclaimer of warranties. You may not distribute the Executable Files or Source Code with any technological measures that control access or use of the Work in a manner inconsistent with the terms of this License.
- f. You agree not to use the Work for illegal, immoral or improper purposes, or on pages containing illegal, immoral or improper material. The Work is subject to applicable export laws. You agree to comply with all such laws and regulations that may apply to the Work after Your receipt of the Work.



6. Representations, Warranties and Disclaimer. THIS WORK IS PROVIDED "AS IS", "WHERE IS" AND "AS AVAILABLE", WITHOUT ANY EXPRESS OR IMPLIED WARRANTIES OR CONDITIONS OR GUARANTEES. YOU, THE USER, ASSUME ALL RISK IN ITS USE, INCLUDING COPYRIGHT INFRINGEMENT, PATENT INFRINGEMENT, SUITABILITY, ETC. AUTHOR EXPRESSLY DISCLAIMS ALL EXPRESS, IMPLIED OR STATUTORY WARRANTIES OR CONDITIONS, INCLUDING WITHOUT LIMITATION, WARRANTIES OR CONDITIONS OF MERCHANTABILITY, MERCHANTABLE QUALITY OR FITNESS FOR A PARTICULAR PURPOSE, OR ANY WARRANTY OF TITLE OR NON-INFRINGEMENT, OR THAT THE WORK (OR ANY PORTION THEREOF) IS CORRECT, USEFUL, BUG-FREE OR FREE OF VIRUSES. YOU MUST PASS THIS DISCLAIMER ON WHENEVER YOU DISTRIBUTE THE WORK OR DERIVATIVE WORKS.
7. Indemnity. You agree to defend, indemnify and hold harmless the Author and the Publisher from and against any claims, suits, losses, damages, liabilities, costs, and expenses (including reasonable legal or attorneys' fees) resulting from or relating to any use of the Work by You.
8. Limitation on Liability. EXCEPT TO THE EXTENT REQUIRED BY APPLICABLE LAW, IN NO EVENT WILL THE AUTHOR OR THE PUBLISHER BE LIABLE TO YOU ON ANY LEGAL THEORY FOR ANY SPECIAL, INCIDENTAL, CONSEQUENTIAL, PUNITIVE OR EXEMPLARY DAMAGES ARISING OUT OF THIS LICENSE OR THE USE OF THE WORK OR OTHERWISE, EVEN IF THE AUTHOR OR THE PUBLISHER HAS BEEN ADVISED OF THE POSSIBILITY OF SUCH DAMAGES.
9. Termination.
- This License and the rights granted hereunder will terminate automatically upon any breach by You of any term of this License. Individuals or entities who have received Derivative Works from You under this License, however, will not have their licenses terminated provided such individuals or entities remain in full compliance with those licenses. Sections 1, 2, 6, 7, 8, 9, 10 and 11 will survive any termination of this License.
 - If You bring a copyright, trademark, patent or any other infringement claim against any contributor over infringements You claim are made by the Work, your License from such contributor to the Work ends automatically.
 - Subject to the above terms and conditions, this License is perpetual (for the duration of the applicable copyright in the Work). Notwithstanding the above, the Author reserves the right to release the Work under different license terms or to stop distributing the Work at any time; provided, however that any such election will not serve to withdraw this License (or any other license that has been, or is required to be, granted under the terms of this License), and this License will continue in full force and effect unless terminated as stated above.
10. Publisher. The parties hereby confirm that the Publisher shall not, under any circumstances, be responsible for and shall not have any liability in respect of the subject matter of this License. The Publisher makes no warranty whatsoever in connection with the Work and shall not be liable to You or any party on any legal theory for any damages whatsoever, including without limitation any general, special, incidental or consequential damages arising in connection to this license. The Publisher reserves the right to cease making the Work available to You at any time without notice
11. Miscellaneous
- This License shall be governed by the laws of the location of the head office of the Author or if the Author is an individual, the laws of location of the principal place of residence of the Author.
 - If any provision of this License is invalid or unenforceable under applicable law, it shall not affect the validity or enforceability of the remainder of the terms of this License, and without further action by the parties to this License, such provision shall be reformed to the minimum extent necessary to make such provision valid and enforceable.
 - No term or provision of this License shall be deemed waived and no breach consented to unless such waiver or consent shall be in writing and signed by the party to be charged with such waiver or consent.
 - This License constitutes the entire agreement between the parties with respect to the Work licensed herein. There are no understandings, agreements or representations with respect to the Work not specified herein. The Author shall not be bound by any additional provisions that may appear in any communication from You. This License may not be modified without the mutual written agreement of the Author and You.

libogg

<http://www.xiph.org/ogg/>

Copyright (c) 2002, Xiph.org Foundation

Redistribution and use in source and binary forms, with or without modification, are permitted provided that the following conditions are met:

- Redistributions of source code must retain the above copyright notice, this list of conditions and the following disclaimer.



- Redistributions in binary form must reproduce the above copyright notice, this list of conditions and the following disclaimer in the documentation and/or other materials provided with the distribution.
- Neither the name of the Xiph.org Foundation nor the names of its contributors may be used to endorse or promote products derived from this software without specific prior written permission.

THIS SOFTWARE IS PROVIDED BY THE COPYRIGHT HOLDERS AND CONTRIBUTORS "AS IS" AND ANY EXPRESS OR IMPLIED WARRANTIES, INCLUDING, BUT NOT LIMITED TO, THE IMPLIED WARRANTIES OF MERCHANTABILITY AND FITNESS FOR A PARTICULAR PURPOSE ARE DISCLAIMED. IN NO EVENT SHALL THE FOUNDATION OR CONTRIBUTORS BE LIABLE FOR ANY DIRECT, INDIRECT, INCIDENTAL, SPECIAL, EXEMPLARY, OR CONSEQUENTIAL DAMAGES (INCLUDING, BUT NOT LIMITED TO, PROCUREMENT OF SUBSTITUTE GOODS OR SERVICES; LOSS OF USE, DATA, OR PROFITS; OR BUSINESS INTERRUPTION) HOWEVER CAUSED AND ON ANY THEORY OF LIABILITY, WHETHER IN CONTRACT, STRICT LIABILITY, OR TORT (INCLUDING NEGLIGENCE OR OTHERWISE) ARISING IN ANY WAY OUT OF THE USE OF THIS SOFTWARE, EVEN IF ADVISED OF THE POSSIBILITY OF SUCH DAMAGE.

libvorbis

<http://www.xiph.org/vorbis/>

Copyright (c) 2002-2004 Xiph.org Foundation

Redistribution and use in source and binary forms, with or without modification, are permitted provided that the following conditions are met:

- Redistributions of source code must retain the above copyright notice, this list of conditions and the following disclaimer.
- Redistributions in binary form must reproduce the above copyright notice, this list of conditions and the following disclaimer in the documentation and/or other materials provided with the distribution.
- Neither the name of the Xiph.org Foundation nor the names of its contributors may be used to endorse or promote products derived from this software without specific prior written permission.

THIS SOFTWARE IS PROVIDED BY THE COPYRIGHT HOLDERS AND CONTRIBUTORS "AS IS" AND ANY EXPRESS OR IMPLIED WARRANTIES, INCLUDING, BUT NOT LIMITED TO, THE IMPLIED WARRANTIES OF MERCHANTABILITY AND FITNESS FOR A PARTICULAR PURPOSE ARE DISCLAIMED. IN NO EVENT SHALL THE FOUNDATION OR CONTRIBUTORS BE LIABLE FOR ANY DIRECT, INDIRECT, INCIDENTAL, SPECIAL, EXEMPLARY, OR CONSEQUENTIAL DAMAGES (INCLUDING, BUT NOT LIMITED TO, PROCUREMENT OF SUBSTITUTE GOODS OR SERVICES; LOSS OF USE, DATA, OR PROFITS; OR BUSINESS INTERRUPTION) HOWEVER CAUSED AND ON ANY THEORY OF LIABILITY, WHETHER IN CONTRACT, STRICT LIABILITY, OR TORT (INCLUDING NEGLIGENCE OR OTHERWISE) ARISING IN ANY WAY OUT OF THE USE OF THIS SOFTWARE, EVEN IF ADVISED OF THE POSSIBILITY OF SUCH DAMAGE.

Tremolo

<http://wss.co.uk/pinknoise/tremolo>

Copyright (C) 2002-2009 Xiph.org Foundation Changes
Copyright (C) 2009-2010 Robin Watts for Pinknoise Productions Ltd

Redistribution and use in source and binary forms, with or without modification, are permitted provided that the following conditions are met:

- Redistributions of source code must retain the above copyright notice, this list of conditions and the following disclaimer.
- Redistributions in binary form must reproduce the above copyright notice, this list of conditions and the following disclaimer in the documentation and/or other materials provided with the distribution.
- Neither the name of the Xiph.org Foundation nor the names of its contributors may be used to endorse or promote products derived from this software without specific prior written permission.

THIS SOFTWARE IS PROVIDED BY THE COPYRIGHT HOLDERS AND CONTRIBUTORS "AS IS" AND ANY EXPRESS OR IMPLIED WARRANTIES, INCLUDING, BUT NOT LIMITED TO, THE IMPLIED WARRANTIES OF MERCHANTABILITY AND FITNESS FOR A PARTICULAR PURPOSE ARE DISCLAIMED. IN NO EVENT SHALL THE FOUNDATION OR CONTRIBUTORS BE LIABLE FOR ANY DIRECT, INDIRECT, INCIDENTAL, SPECIAL, EXEMPLARY, OR CONSEQUENTIAL DAMAGES (INCLUDING, BUT NOT LIMITED TO, PROCUREMENT OF SUBSTITUTE GOODS OR SERVICES; LOSS OF USE, DATA, OR PROFITS; OR BUSINESS INTERRUPTION) HOWEVER CAUSED AND ON ANY THEORY OF LIABILITY, WHETHER IN CONTRACT, STRICT LIABILITY, OR TORT (INCLUDING NEGLIGENCE OR OTHERWISE) ARISING IN ANY WAY OUT OF THE USE OF THIS SOFTWARE, EVEN IF ADVISED OF THE POSSIBILITY OF SUCH DAMAGE.



❑ Tremor

<http://wiki.xiph.org/index.php/Tremor>

Copyright (c) 2002, Xiph.org Foundation

Redistribution and use in source and binary forms, with or without modification, are permitted provided that the following conditions are met:

- Redistributions of source code must retain the above copyright notice, this list of conditions and the following disclaimer.
- Redistributions in binary form must reproduce the above copyright notice, this list of conditions and the following disclaimer in the documentation and/or other materials provided with the distribution.
- Neither the name of the Xiph.org Foundation nor the names of its contributors may be used to endorse or promote products derived from this software without specific prior written permission.

THIS SOFTWARE IS PROVIDED BY THE COPYRIGHT HOLDERS AND CONTRIBUTORS "AS IS" AND ANY EXPRESS OR IMPLIED WARRANTIES, INCLUDING, BUT NOT LIMITED TO, THE IMPLIED WARRANTIES OF MERCHANTABILITY AND FITNESS FOR A PARTICULAR PURPOSE ARE DISCLAIMED. IN NO EVENT SHALL THE FOUNDATION OR CONTRIBUTORS BE LIABLE FOR ANY DIRECT, INDIRECT, INCIDENTAL, SPECIAL, EXEMPLARY, OR CONSEQUENTIAL DAMAGES (INCLUDING, BUT NOT LIMITED TO, PROCUREMENT OF SUBSTITUTE GOODS OR SERVICES; LOSS OF USE, DATA, OR PROFITS; OR BUSINESS INTERRUPTION) HOWEVER CAUSED AND ON ANY THEORY OF LIABILITY, WHETHER IN CONTRACT, STRICT LIABILITY, OR TORT (INCLUDING NEGLIGENCE OR OTHERWISE) ARISING IN ANY WAY OUT OF THE USE OF THIS SOFTWARE, EVEN IF ADVISED OF THE POSSIBILITY OF SUCH DAMAGE.

❑ Mersenne Twister

<http://www.math.sci.hiroshima-u.ac.jp/~m-mat/MT/MT2002/CODES/mt19937ar.c>

Copyright (C) 1997 - 2002, Makoto Matsumoto and Takuji Nishimura,
All rights reserved.

Redistribution and use in source and binary forms, with or without modification, are permitted provided that the following conditions are met:

1. Redistributions of source code must retain the above copyright notice, this list of conditions and the following disclaimer.

2. Redistributions in binary form must reproduce the above copyright notice, this list of conditions and the following disclaimer in the documentation and/or other materials provided with the distribution.
3. The names of its contributors may not be used to endorse or promote products derived from this software without specific prior written permission.

THIS SOFTWARE IS PROVIDED BY THE COPYRIGHT HOLDERS AND CONTRIBUTORS "AS IS" AND ANY EXPRESS OR IMPLIED WARRANTIES, INCLUDING, BUT NOT LIMITED TO, THE IMPLIED WARRANTIES OF MERCHANTABILITY AND FITNESS FOR A PARTICULAR PURPOSE ARE DISCLAIMED. IN NO EVENT SHALL THE COPYRIGHT OWNER OR CONTRIBUTORS BE LIABLE FOR ANY DIRECT, INDIRECT, INCIDENTAL, SPECIAL, EXEMPLARY, OR CONSEQUENTIAL DAMAGES (INCLUDING, BUT NOT LIMITED TO, PROCUREMENT OF SUBSTITUTE GOODS OR SERVICES; LOSS OF USE, DATA, OR PROFITS; OR BUSINESS INTERRUPTION) HOWEVER CAUSED AND ON ANY THEORY OF LIABILITY, WHETHER IN CONTRACT, STRICT LIABILITY, OR TORT (INCLUDING NEGLIGENCE OR OTHERWISE) ARISING IN ANY WAY OUT OF THE USE OF THIS SOFTWARE, EVEN IF ADVISED OF THE POSSIBILITY OF SUCH DAMAGE.



**zlib**

<http://www.zlib.net/>

zlib.h – interface of the ‘zlib’ general purpose compression library version 1.2.3, July 18th, 2005

Copyright (C) 1995-2004 Jean-loup Gailly and Mark Adler

This software is provided ‘as-is’, without any express or implied warranty. In no event will the authors be held liable for any damages arising from the use of this software.

Permission is granted to anyone to use this software for any purpose, including commercial applications, and to alter it and redistribute it freely, subject to the following restrictions:

1. The origin of this software must not be misrepresented; you must not claim that you wrote the original software. If you use this software in a product, an acknowledgment in the product documentation would be appreciated but is not required.
2. Altered source versions must be plainly marked as such, and must not be misrepresented as being the original software.
3. This notice may not be removed or altered from any source distribution.

Jean-loup Gailly jloup@gzip.org, Mark Adler madler@alumni.caltech.edu

**cURL**

<http://curl.haxx.se>

COPYRIGHT AND PERMISSION NOTICE

Copyright (c) 1996 - 2011, Daniel Stenberg, <daniel@haxx.se>.

All rights reserved.

Permission to use, copy, modify, and distribute this software for any purpose with or without fee is hereby granted, provided that the above copyright notice and this permission notice appear in all copies.

THE SOFTWARE IS PROVIDED “AS IS”, WITHOUT WARRANTY OF ANY KIND, EXPRESS OR IMPLIED, INCLUDING BUT NOT LIMITED TO THE WARRANTIES OF MERCHANTABILITY, FITNESS FOR A PARTICULAR PURPOSE AND NONINFRINGEMENT OF THIRD PARTY RIGHTS. IN NO EVENT SHALL THE AUTHORS OR COPYRIGHT HOLDERS BE LIABLE FOR ANY CLAIM, DAMAGES OR OTHER LIABILITY, WHETHER IN AN ACTION OF CONTRACT, TORT OR OTHERWISE, ARISING FROM, OUT OF OR IN CONNECTION WITH THE SOFTWARE OR THE USE OR OTHER DEALINGS IN THE SOFTWARE.

Except as contained in this notice, the name of a copyright holder shall not be used in advertising or otherwise to promote the sale, use or other dealings in this Software without prior written authorization of the copyright holder.

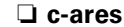
**c-ares**

<http://c-ares.haxx.se>

Copyright 1998 by the Massachusetts Institute of Technology.

Permission to use, copy, modify, and distribute this software and its documentation for any purpose and without fee is hereby granted, provided that the above copyright notice appear in all copies and that both that copyright notice and this permission notice appear in supporting documentation, and that the name of M.I.T. not be used in advertising or publicity pertaining to distribution of the software without specific, written prior permission. M.I.T. makes no representations about the suitability of this software for any purpose. It is provided “as is” without express or implied warranty.



■ License Information for the Software Used in the Unit

About GPL (GNU-General Public License), LGPL (GNU Lesser General Public License) License

This product uses GPL/LGPL software and software made by other companies.

After you purchase this product, you may procure, modify or distribute the source code of the GPL/LGPL software that is used in the product.

Denon provides the source code based on the GPL and LPGL licenses at the actual cost upon your request to our customer service center. However, note that we make no guarantees concerning the source code. Please also understand that we do not offer support for the contents of the source code.



■ Dimensions

Unit : mm

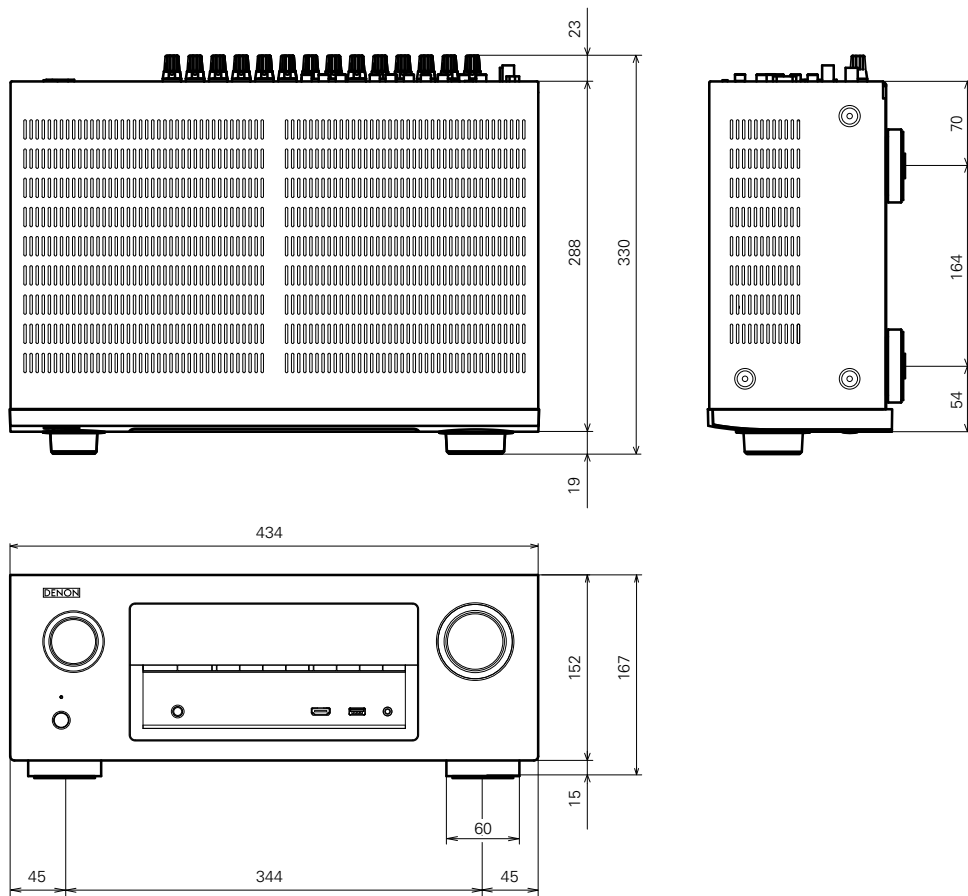

■ Weight : 9.5 kg

Front panel

Display

Rear panel

219

Remote

Index



DENON

www.denon.com

D&M Holdings Inc.
3520 10215 20AD